

Beam size effect on Signal Loss *including Baffle effect*

v3 analysis was wrong!!!
Baffle was placed in front of ITM

Hiro Yamamoto

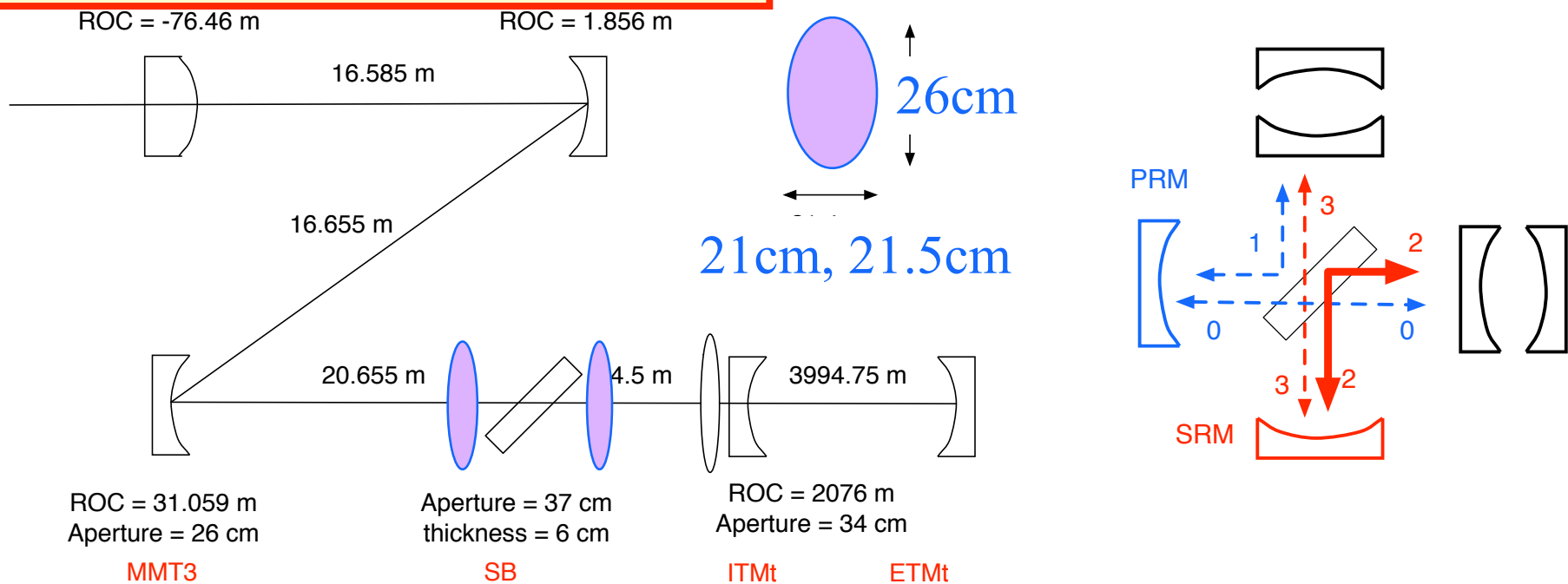

Optic:	Beam Size	PRM	PR2	PR3	SRM	SR2	SR3	ITM	ETM
ROC (m):	5.31 cm	11.63	-1.491	34	-18.35	-3.258	34	1935	2243
ROC (m):	5.55 cm	11.37	-1.48	34	-15.0	-3.261	34	1971	2191
ROC (m):	5.956cm	10.98	-1.451	34	-11.755	-3.256	34	2076	2076

frequency dependence of signal SB Loss on SRM

- lock by injecting CR from RM
- add $\pi/4$ to Michelson cavity
- shake ETM
- calculate 00 mode to RM
- loss = $1 - E_{00}/E_{00}(\text{max})$
- $E_{00}(\text{max}) : 5.55\text{cm}$
ROCs with large optics

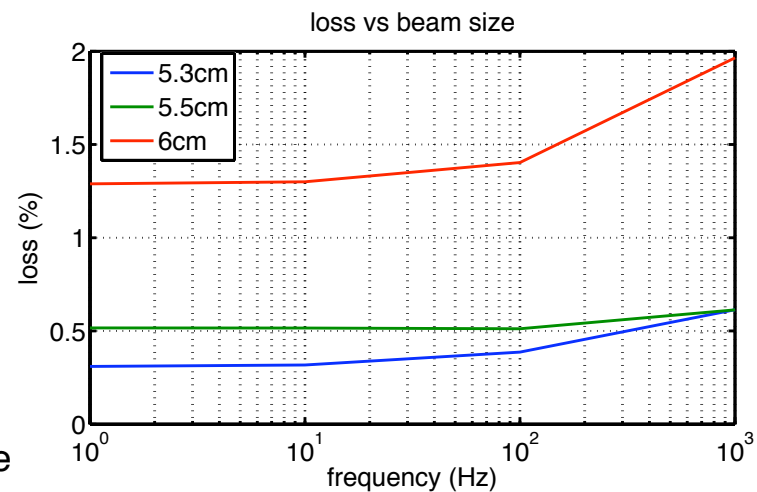
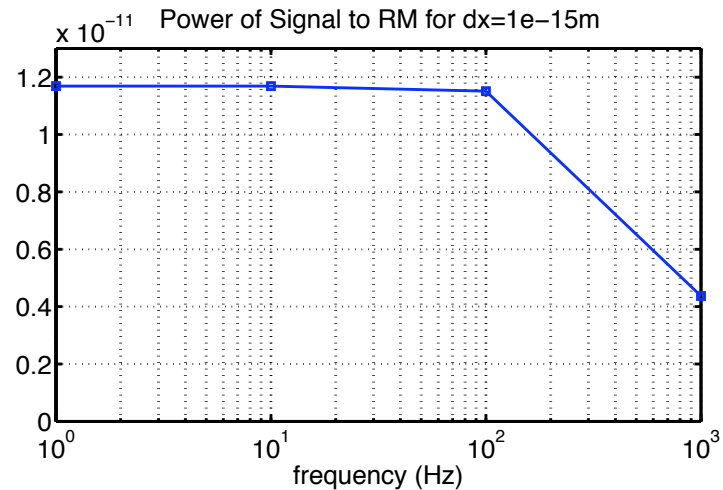

beam offset effect on loss

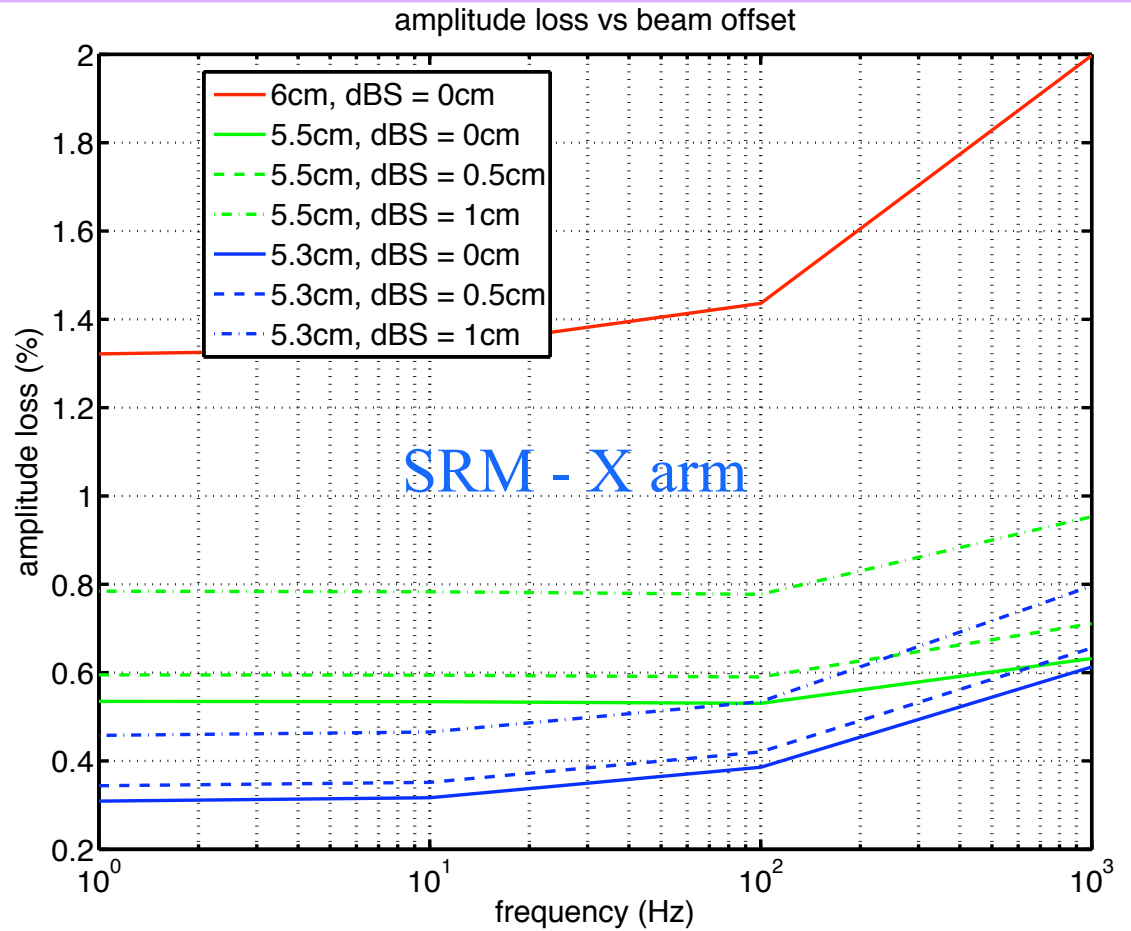
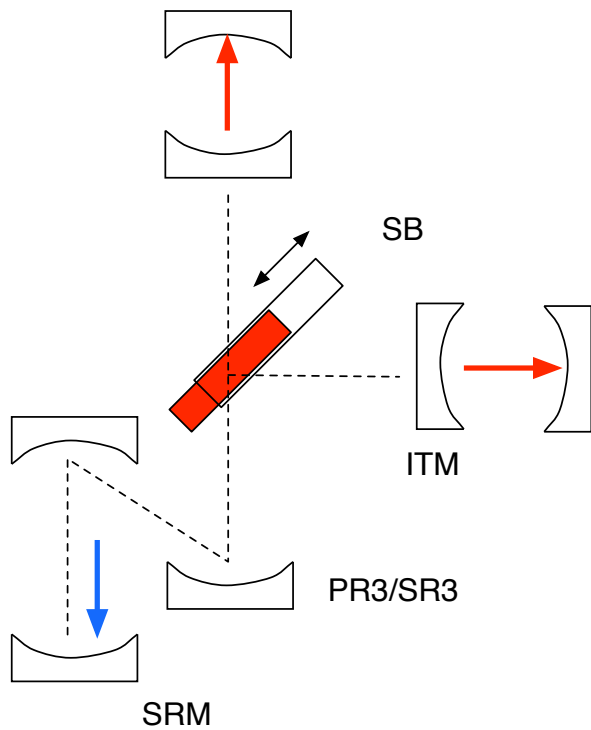

amplitude loss vs beam size

PRM : TEM00 on ETM

SRM : TEM00 on SRM

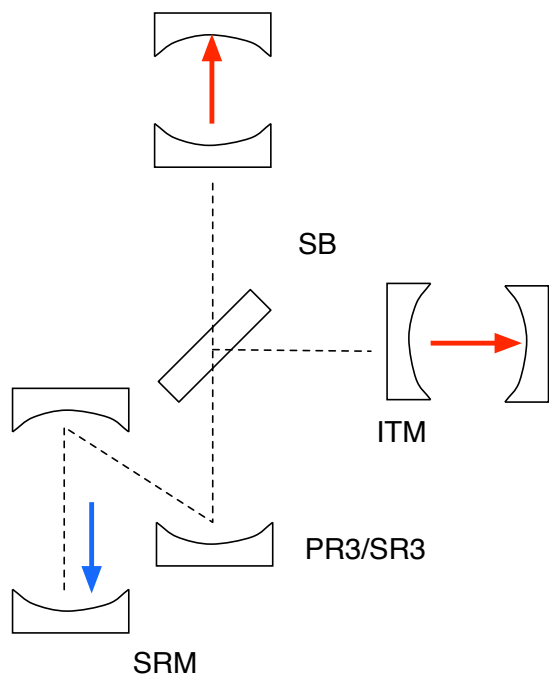

G0810029-v4

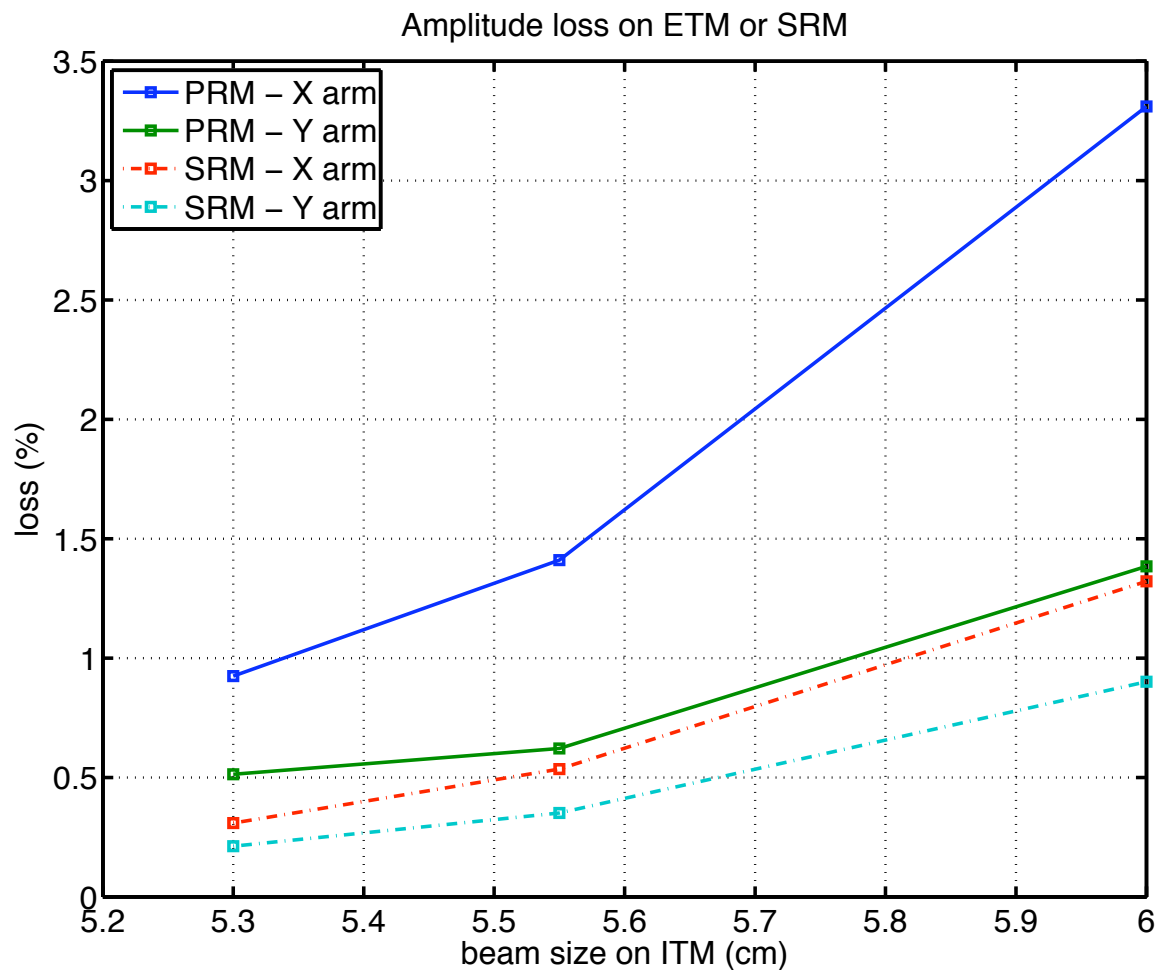

Hiro Yamamoto COC meeting @ CIT on January 20, 2009

same baffle in 4 directions

amplitude loss in the TEM00 in the arm

	PRM - Xarm	PRM - Yarm
no baffle	0.92%	0.51%
baffle 260x215	1.14%	0.93%
baffle 260x210	1.28%	1.20%

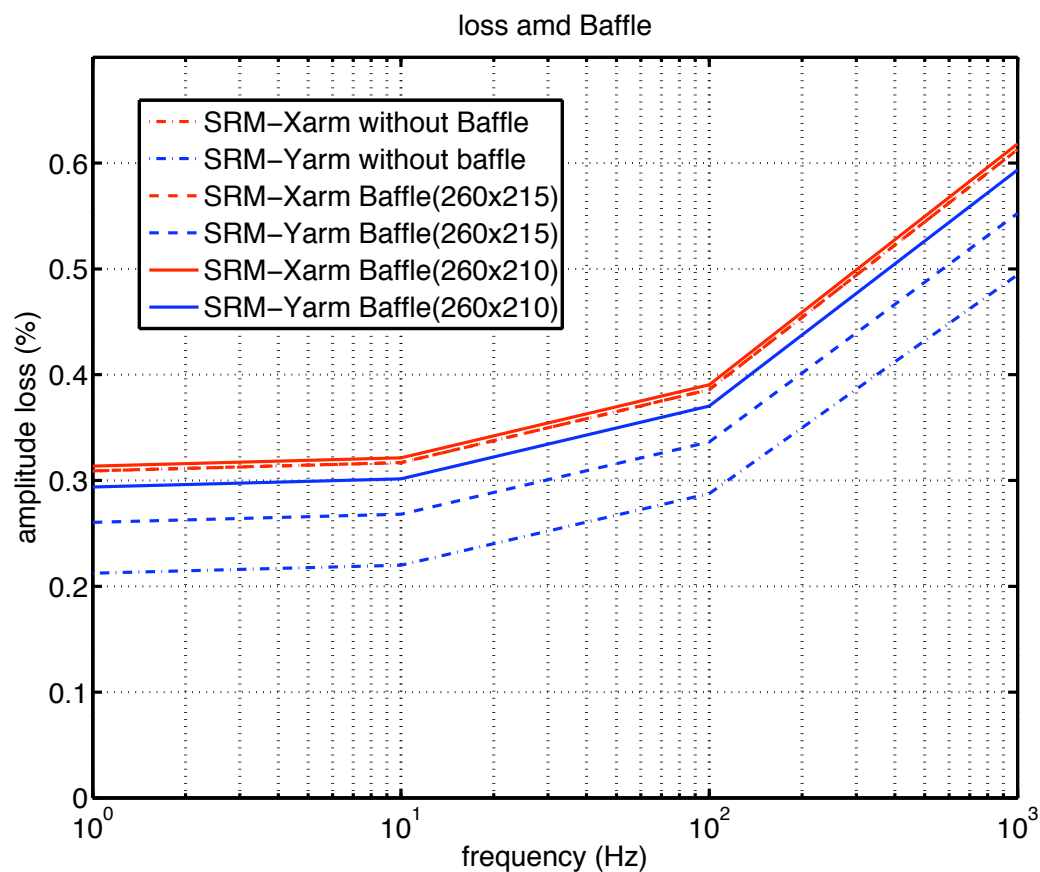

Contrast Defect

Field on BS toward SRM

$$E = E(x\text{-arm}) - E(y\text{-arm}) \exp(i \phi)$$

$$E(0,0) = 0$$

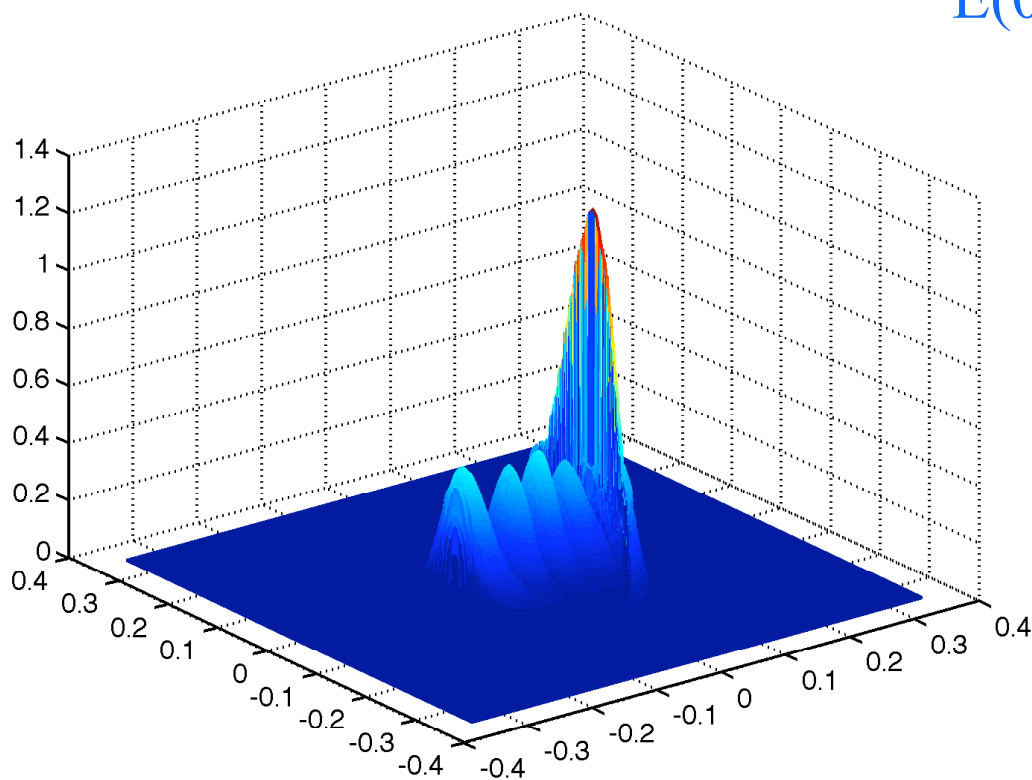

$$CD = \frac{\text{Power}(E(x) - E(y) \exp(i \phi))}{\text{Power}(E(x) + E(y) \exp(i \phi))}$$

$$CD(5.55\text{cm}) = 73\text{ppm}$$

$$CD(5.30\text{cm}) = 36\text{ppm}$$

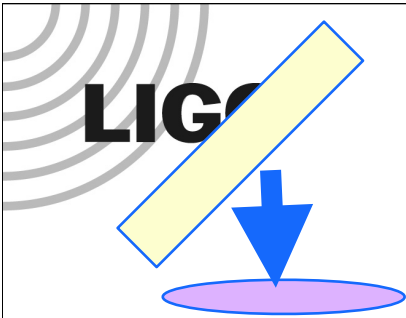

Contrast Defect with baffle

dark field =
 $E_2 - E_3 \exp(i\phi)$

CD

no baffle	36ppm
260x215	12ppm
260x210	5ppm

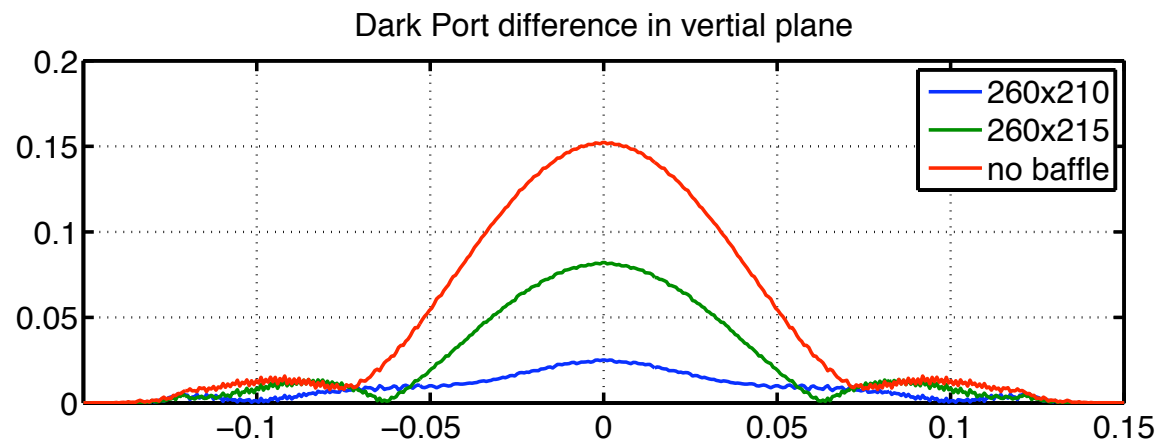
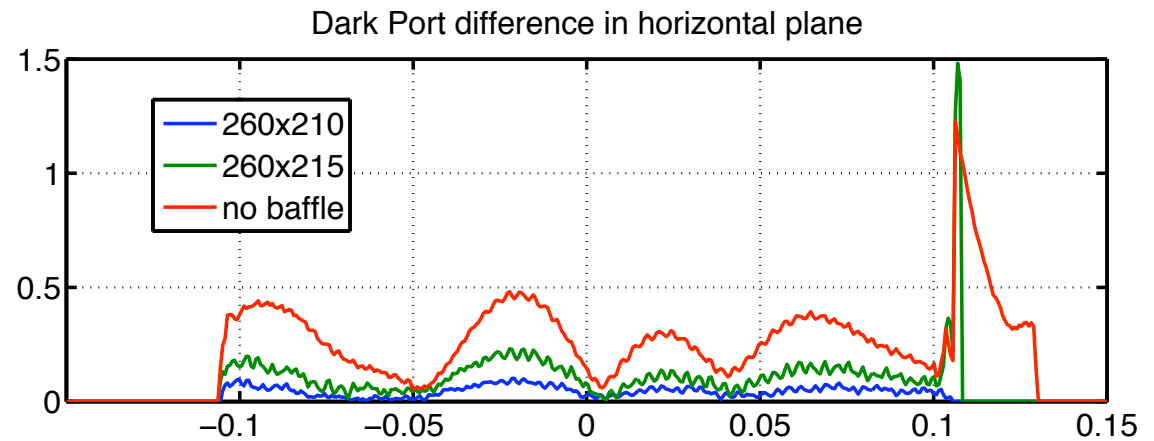

amplitude loss on BS and SR3/PR3

— 00 mode loss
 - - - total loss

$$\text{loss(SR3)} = 1 - \frac{\text{amp}(\text{from SR3 to BS})}{\text{amp}(\text{to SR3 from SR2})}$$

$$\text{loss(BS)} = 1 - \frac{\text{amp}(\text{from BS to SR3})}{\text{amp}(\text{to BS from ITM})}$$

G0810029-v4

H

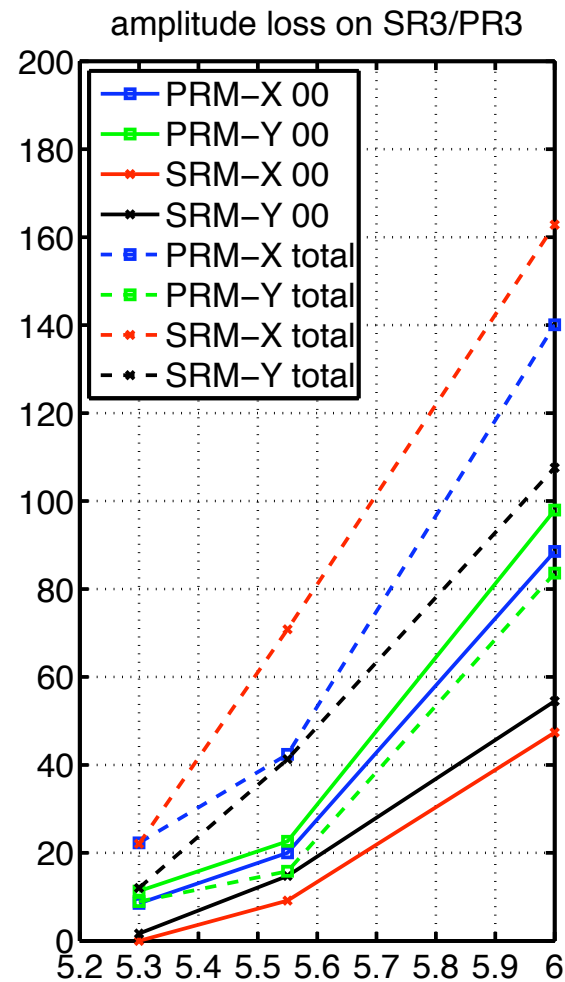
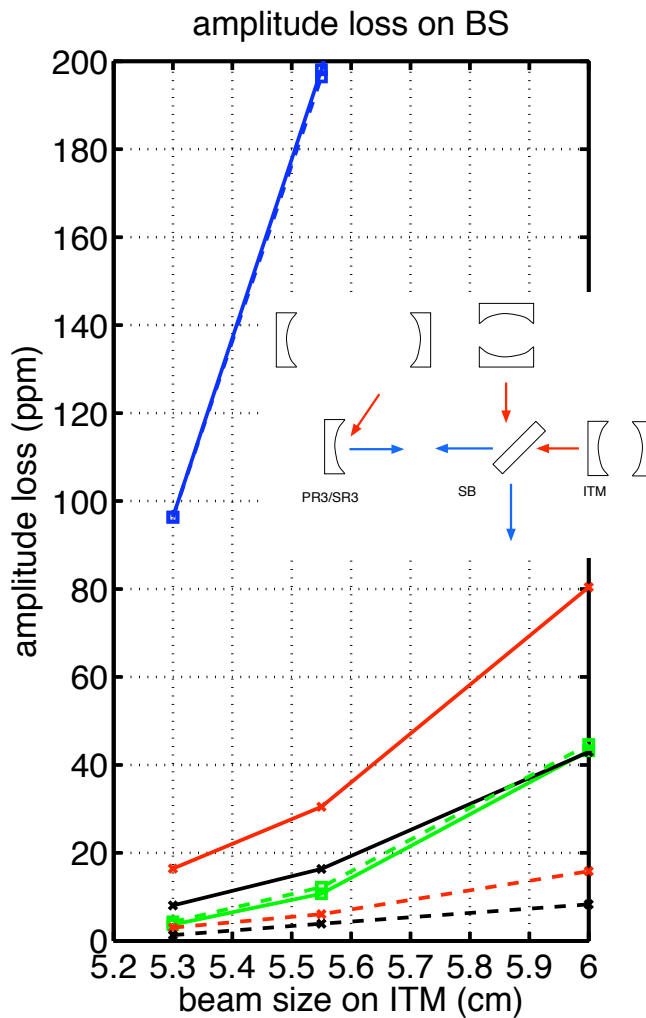

Beam amplitude profile on BS

