

| ITEM NO. | QTY. | DESCRIPTION          | LENGTH |
|----------|------|----------------------|--------|
| 1        | 2    | C CHANNEL, 50.80 X 5 | 1051.6 |
| 2        | 2    | C CHANNEL, 50.80 X 5 | 1562.4 |
| 3        | 1    | C CHANNEL, 50.80 X 5 | 950    |

D:\000201-0000\001-LOWER STRUCTURE FRAME\CONFRAME FRONT PANEL.dwg (REV. 001) DRAWING PLOT REV. X.000

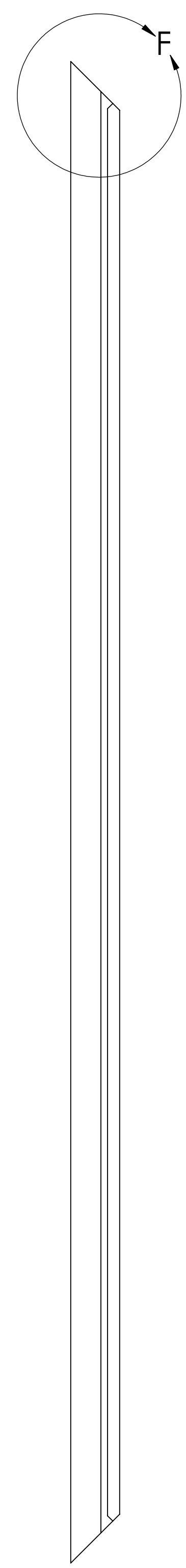

SIDE  
MATERIAL: 6061-T6 ALUM ALLOY  
2 REQ'D

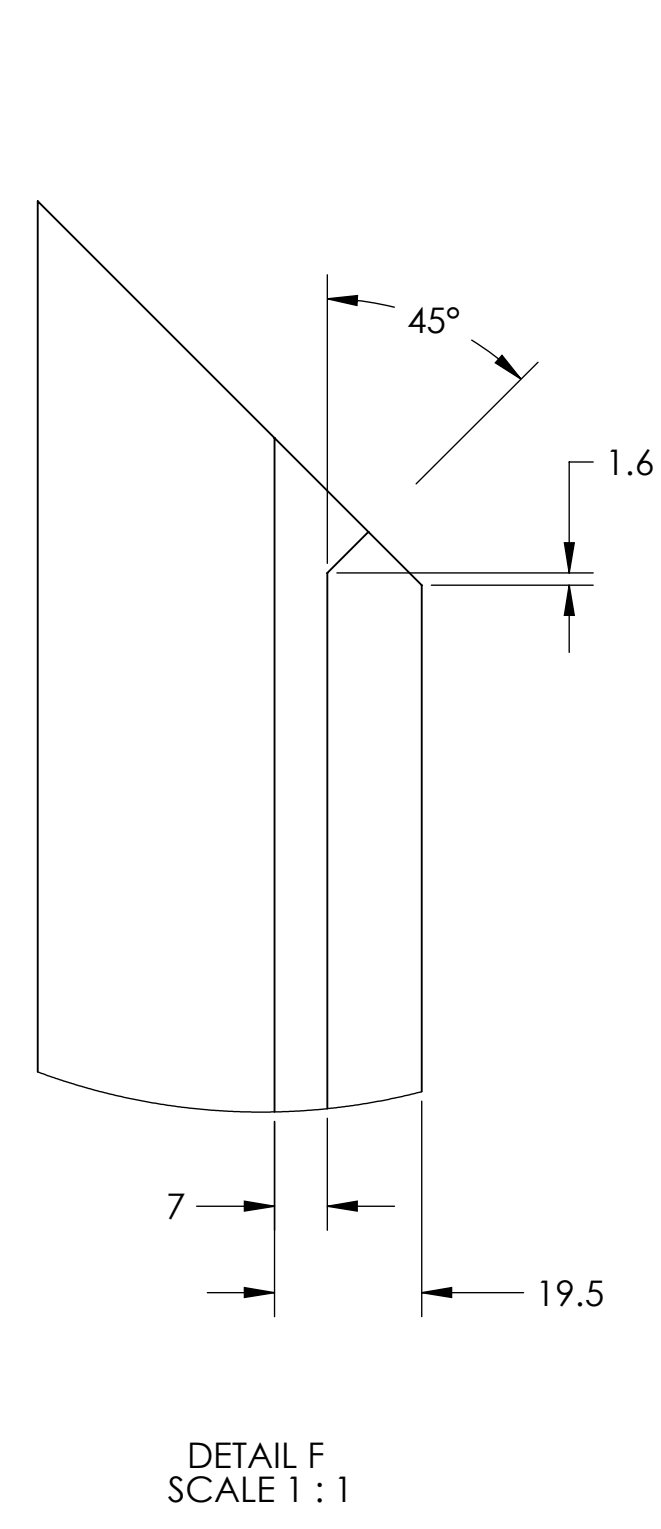
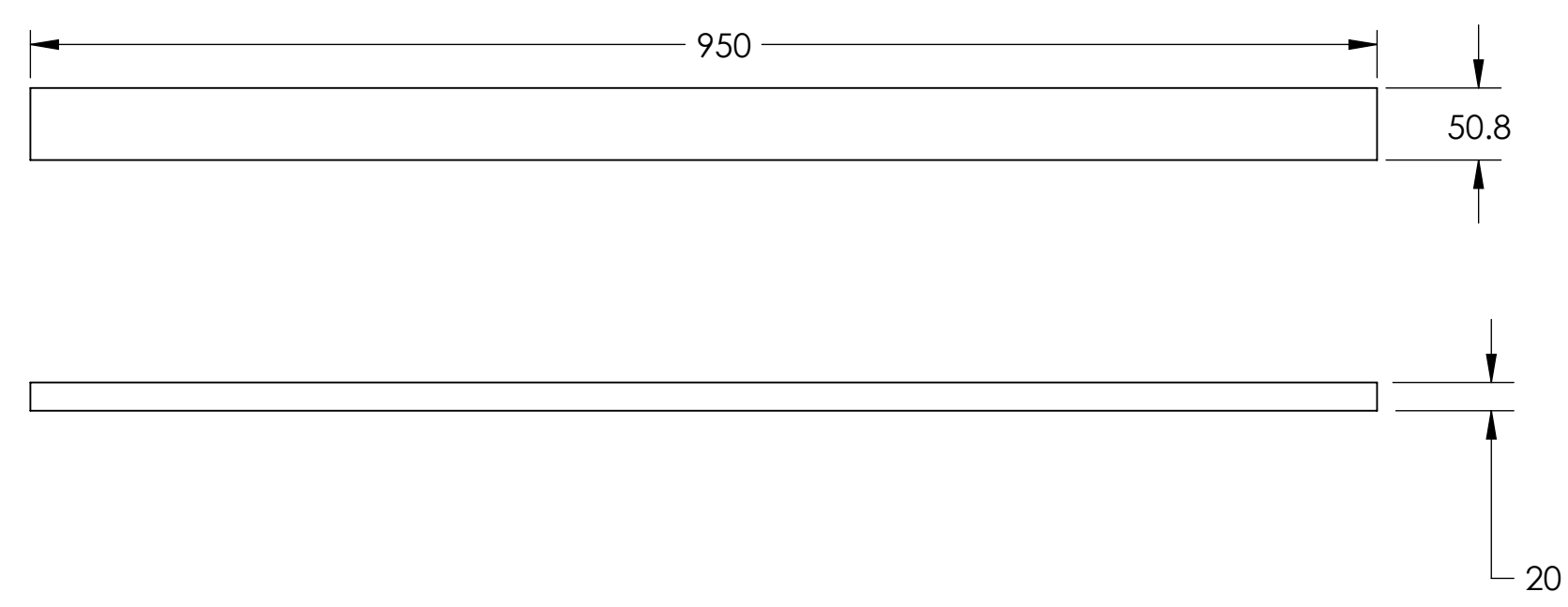
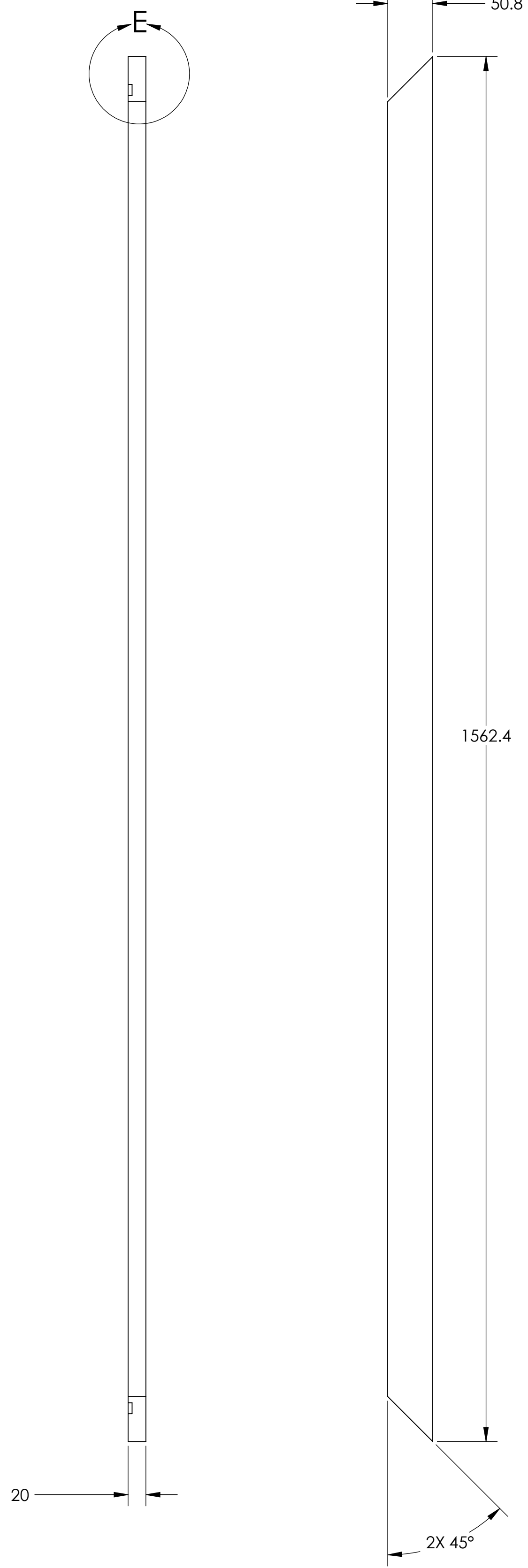
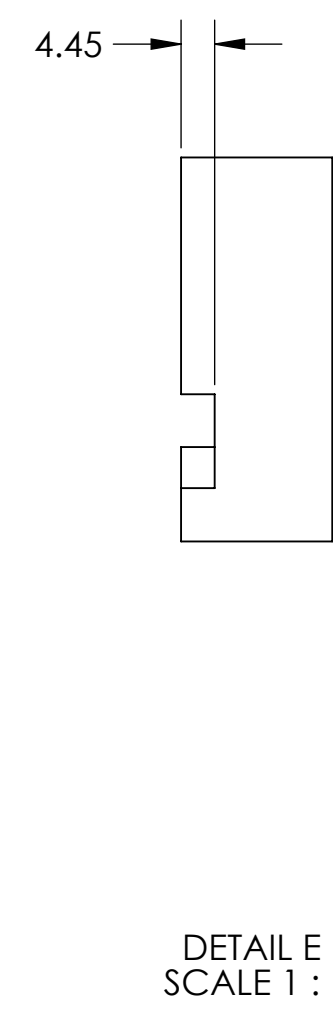

MIDDLE  
MATERIAL: 6061-T6 ALUM ALLOY

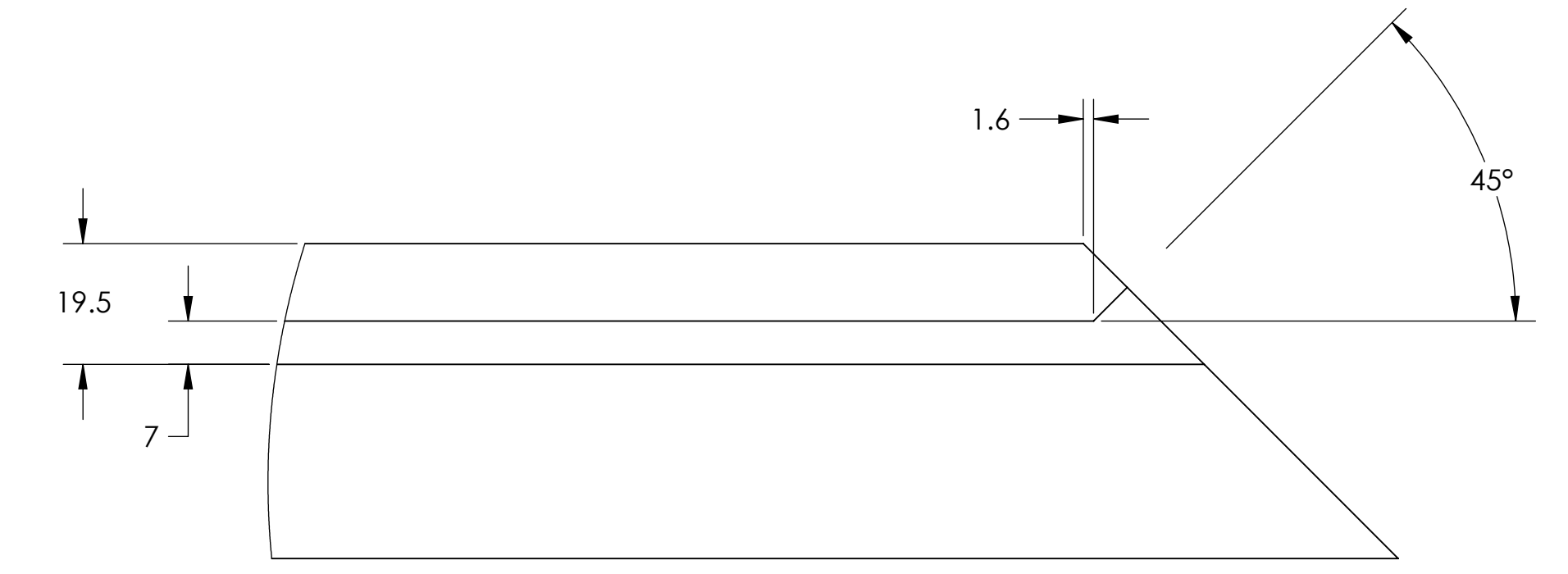
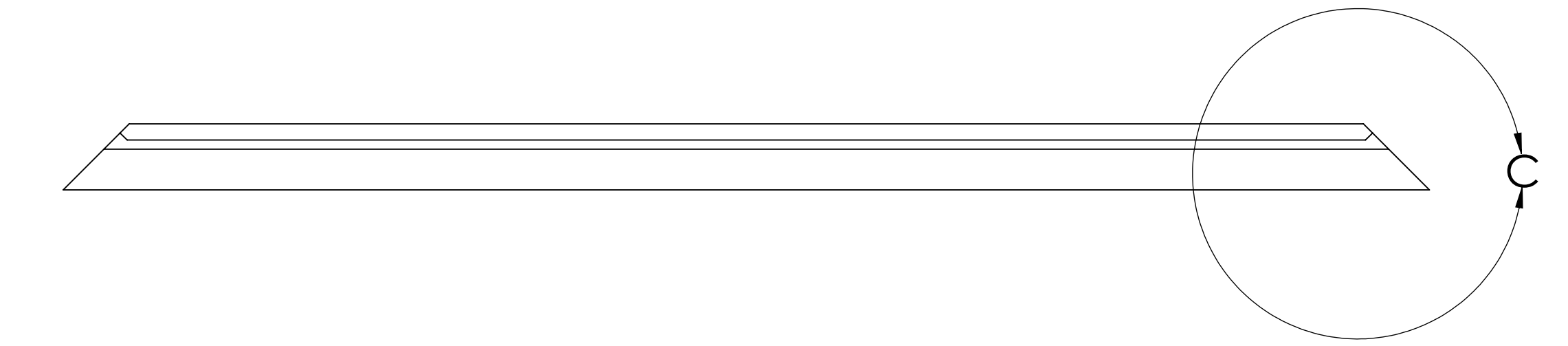
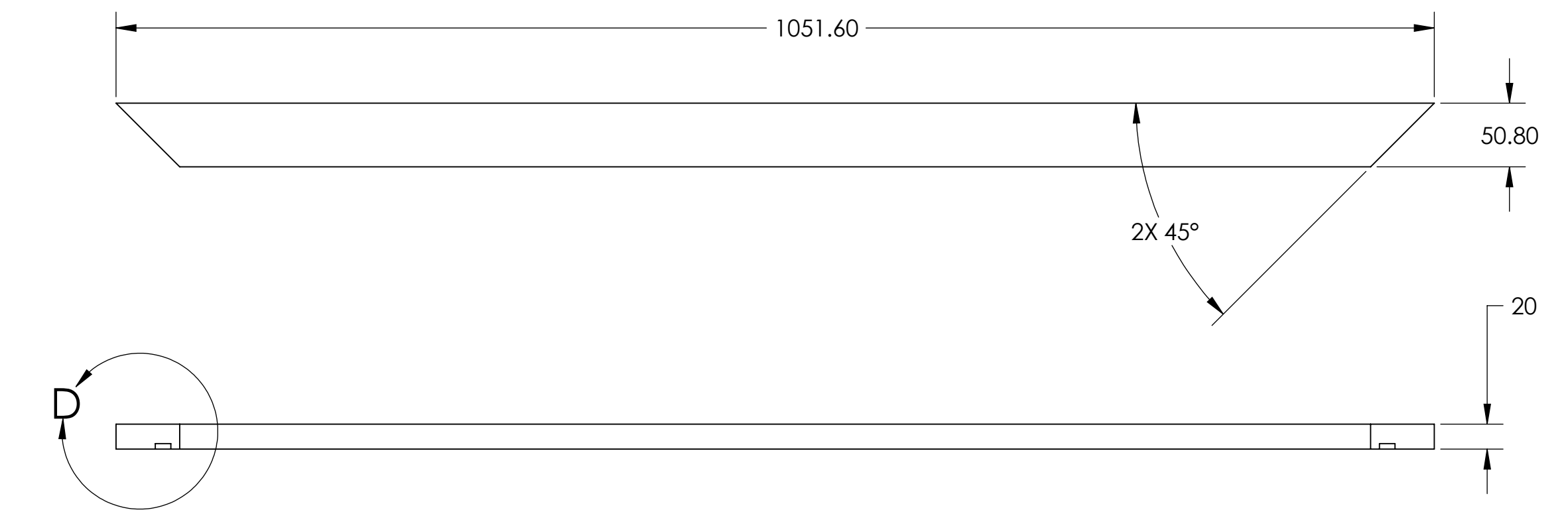
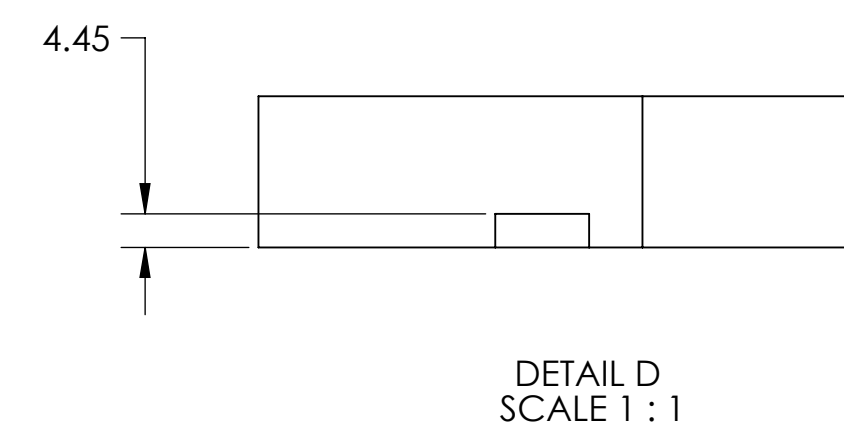

TOP AND BOTTOM  
MATERIAL: 6061-T6 ALUM ALLOY  
2 REQ'D

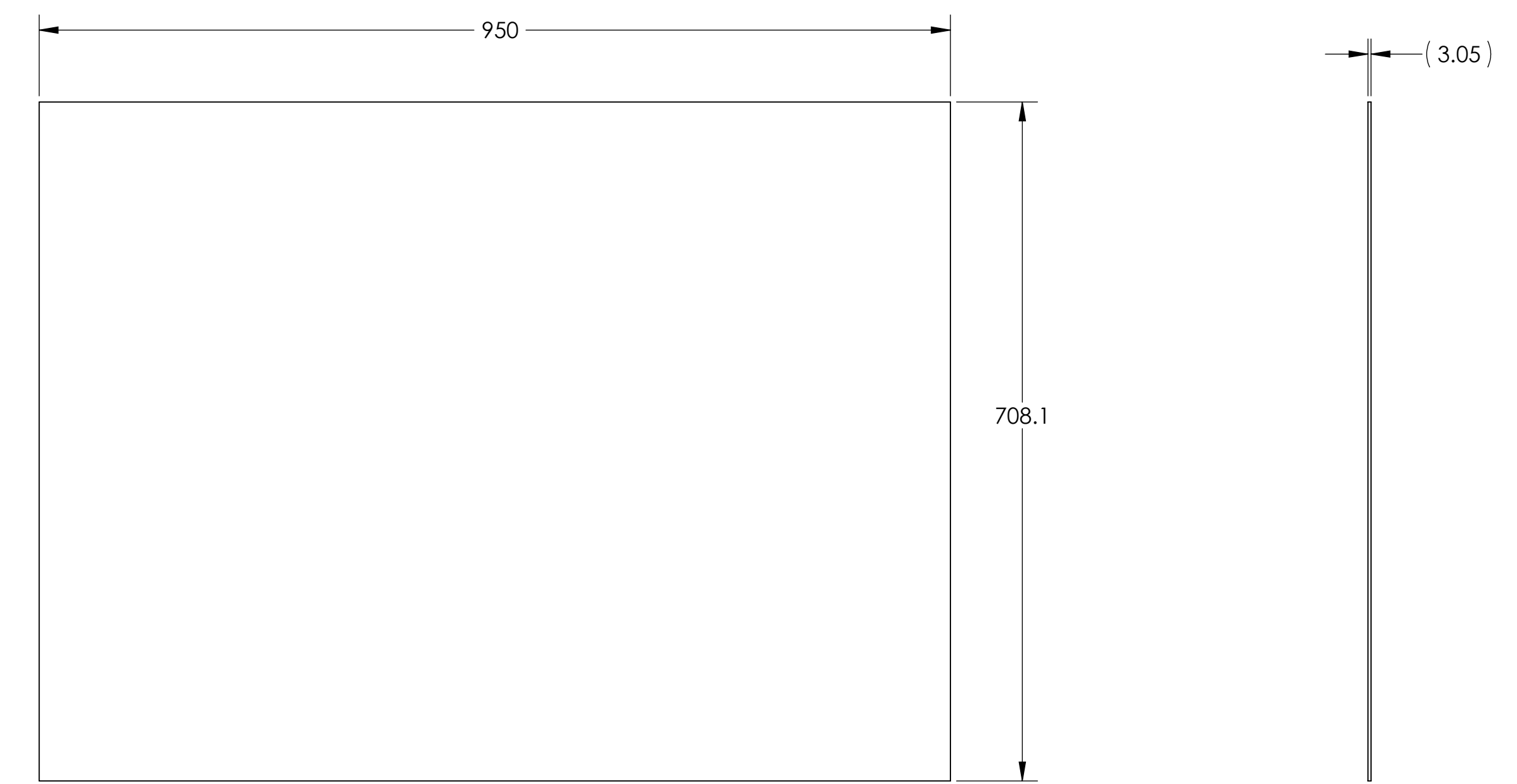

FRONT PANEL SKIN  
MATERIAL: .12 THICK 6061-T6 ALUM ALLOY  
2 REQ'D