



LIGO Laboratory / LIGO Scientific Collaboration

LIGO-E1000338-v1

LIGO

09 August 2010

Vibration Absorber : Final Design Review

S. BISCANS, K.BUCKLAND, B.LANTZ, F.MATICHARD, C. TORRIE

Distribution of this document:
Advanced LIGO Project

This is an internal working note
of the LIGO Laboratory

California Institute of Technology
LIGO Project – MS 18-34
1200 E. California Blvd.
Pasadena, CA 91125
Phone (626) 395-2129
Fax (626) 304-9834
E-mail: info@ligo.caltech.edu

Massachusetts Institute of Technology
LIGO Project – NW22-295
185 Albany St
Cambridge, MA 02139
Phone (617) 253-4824
Fax (617) 253-7014
E-mail: info@ligo.mit.edu

LIGO Hanford Observatory
P.O. Box 1970
Mail Stop S9-02
Richland WA 99352
Phone 509-372-8106
Fax 509-372-8137

LIGO Livingston Observatory
P.O. Box 940
Livingston, LA 70754
Phone 225-686-3100
Fax 225-686-7189



Table of Contents

1	Introduction.....	3
2	Presentation of the R&D investigation	4
2.1	Struts	4
2.2	Corner bracket.....	6
2.3	Vibration absorber	7
2.4	Conclusion	8
3.	Presentation of the chosen solution : the vibration absorber	8
3.1	Design	8
3.2	Results on the quad	10
3.2.1	Experiment presentation	10
3.2.2	External transfer function	10
3.2.3	Experiment with supported mass	12
3.2.4	Experiment presentation with the vibration absorber	14
3.2.5	Quad external structure + vibration transfer function.....	16
3.2.6	Adjustment of parameters	16
3.3	Results on the HLTS	19
3.3.1	Experimental Presentation	19
3.3.2	Transfer function.....	19
3.3.3	Experiment presentation with the vibration absorber	20
3.3.4	Adjustment of parameters	21
4.	Layout	22
5.	Conclusion	22

1 Introduction

aLIGO suspensions will be attached to two types of seismic isolation systems : the BSC-ISI platform and the HAM-ISI platform.



Figure 1 : BSC-ISI platform

The BSC-ISI prototyping commissioning allowed us to identify couplings between the platform and the suspension structure suspended at the optic table, as shown in Figure 2.

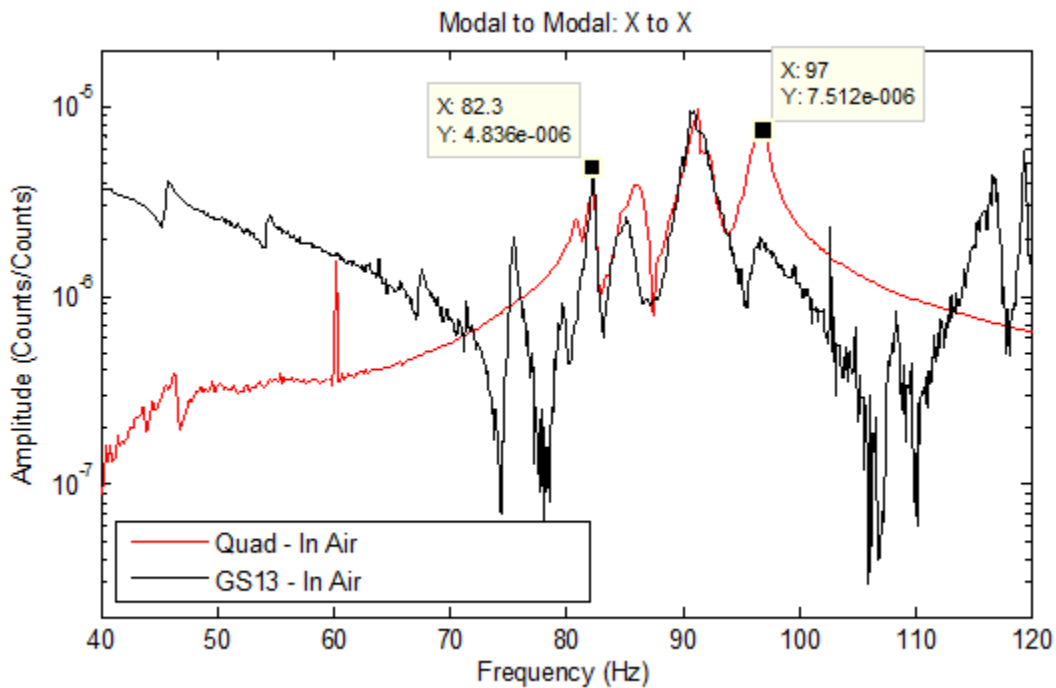

Figure 2

The eLIGO HAM-ISI commissioning also allowed to show how important it is to damp some of the structure resonances to improve the global transfer function of the platform.

The high numbers of modes and their high Qs are limiting factors of performances and it is a source of instabilities for the SEI platform. Thus, solving these issues with an active method is going to be difficult and not robust.

The goal of this report is to present the vibration absorber designed to damp a maximum of those modes. This device has been designed to :

- be simple to install
- not add too much mass
- not take too much footprint on the optic table

It will be installed on the suspension structures : the Quad, the HLTS and the OMC.

The first part of this document sums up all the investigation done by the team during this last year. Then we are going to focus on the device designed for aLIGO: the vibration absorber, and will present the testing results.

2 Presentation of the R&D investigation

This part presents the three methods investigated during the past year : strut, corner bracket and vibration absorber. The vibration absorber has been the chosen solution, because it is the most compact solution which takes the lowest space on the optic table.

2.1 Struts

A first approach to damp modes was to rigidify the system with struts. For example, a strut device system has been built for the OMC Frame in order to damp its modes while it rests on the seismic table. The strut design consists of a 1"x1" aluminum beam set at the seismic table and angled at approximately 60 degrees.

Viton© is clamped between the strut's plate and the OMC Frame. Screws and washers are used to thread into the OMC Frame through the strut's plate without touching the plate (using Viton© between the screw heads and the plate). One of the setup even tried involved placing a Viton© pad parallel to the strut. It was clamped between a plate that was attached to the OMC Frame and the strut. See the pictures and schematic below.

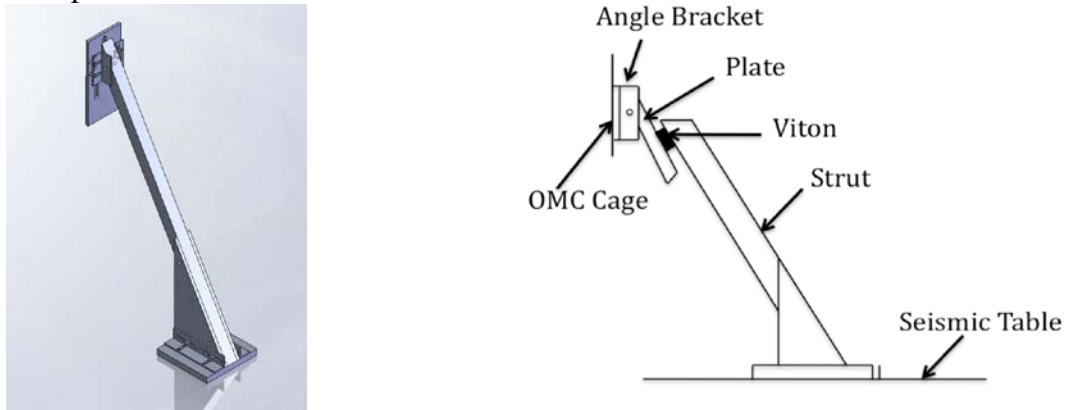

Figure 3 : Vertical setup schematic

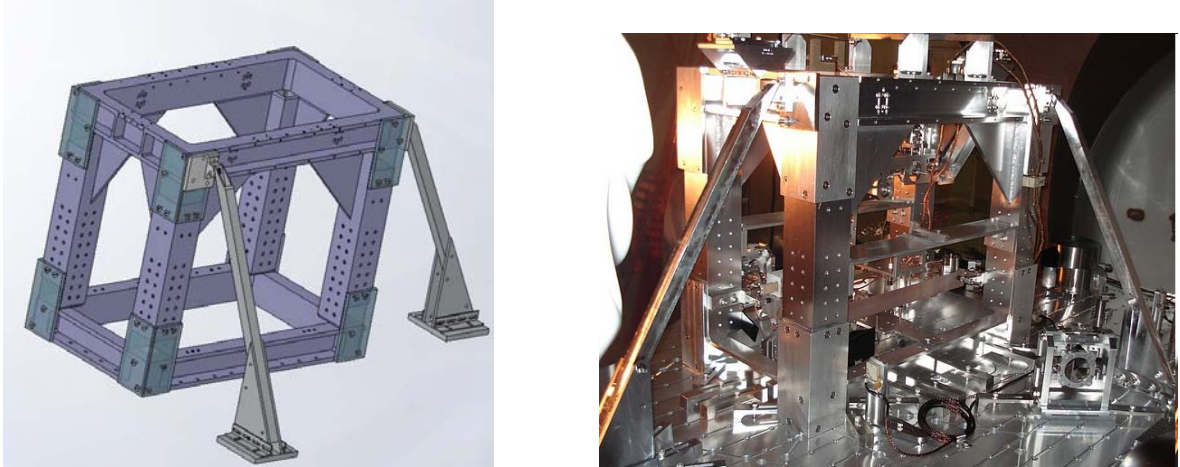

Figure 4 : General overview of the OMC structure with struts

Promising results have been obtained by using struts on the RX and RY directions. The Qs of the main modes have been reduced drastically and no additional modes have been created by the struts, as shown in Figure 5.

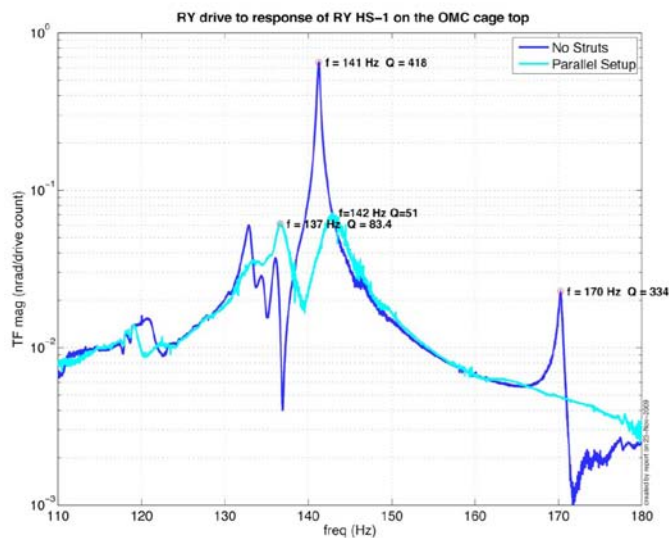

Figure 5

Some similar experiments have been done on the HLTS structure, with very good results too (a damp factor of 10 for some resonances).

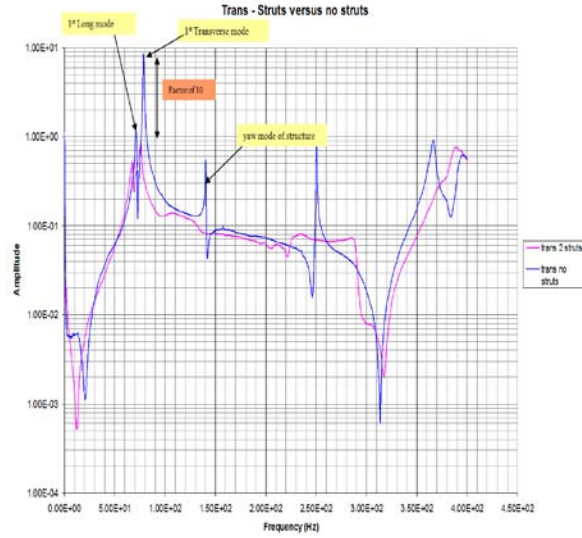
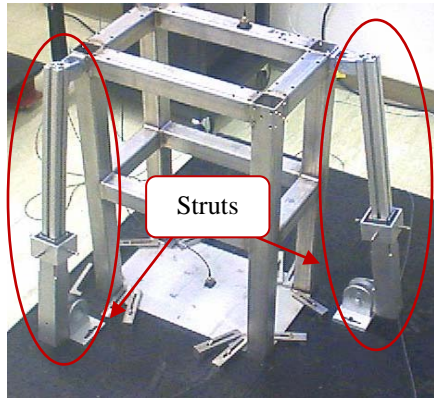

Figure 6

2.2 Corner bracket

The approach consists of adding steel brackets in each corners of the structure. Thanks to a FEA, we know that the corners are the most deformed points of the system. Rigidifying and damping those points should suppress or damp some internal frequencies. Some tests have been done with Viton© clamped between the brackets and the structure frame.

For example, such a system was developed on the OMC structure, as shown in Figure 7.

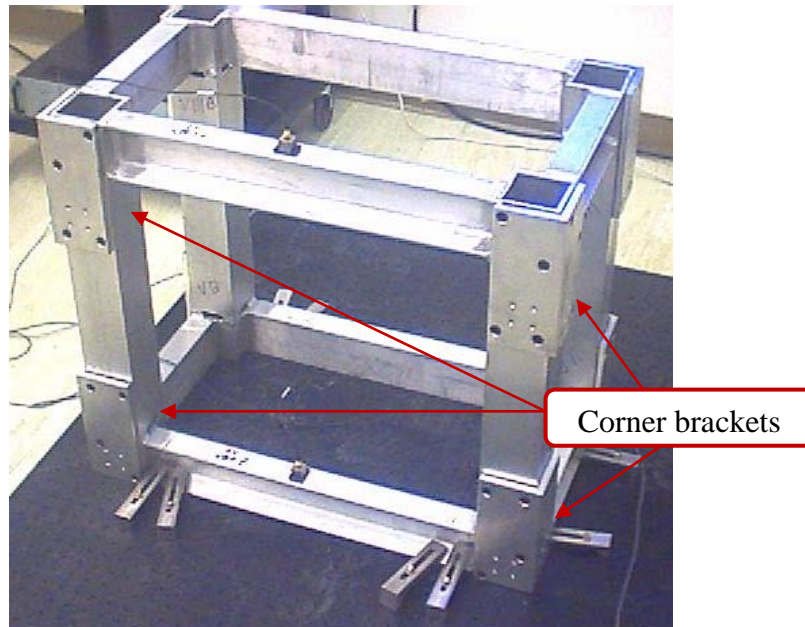

Figure 7

Promising results have been obtained. The Qs of the main modes have been reduced drastically and no additional modes have been created by the struts, as shown in Figure 8.

OMC - Long excite with long measure - updated plates Dec 2009

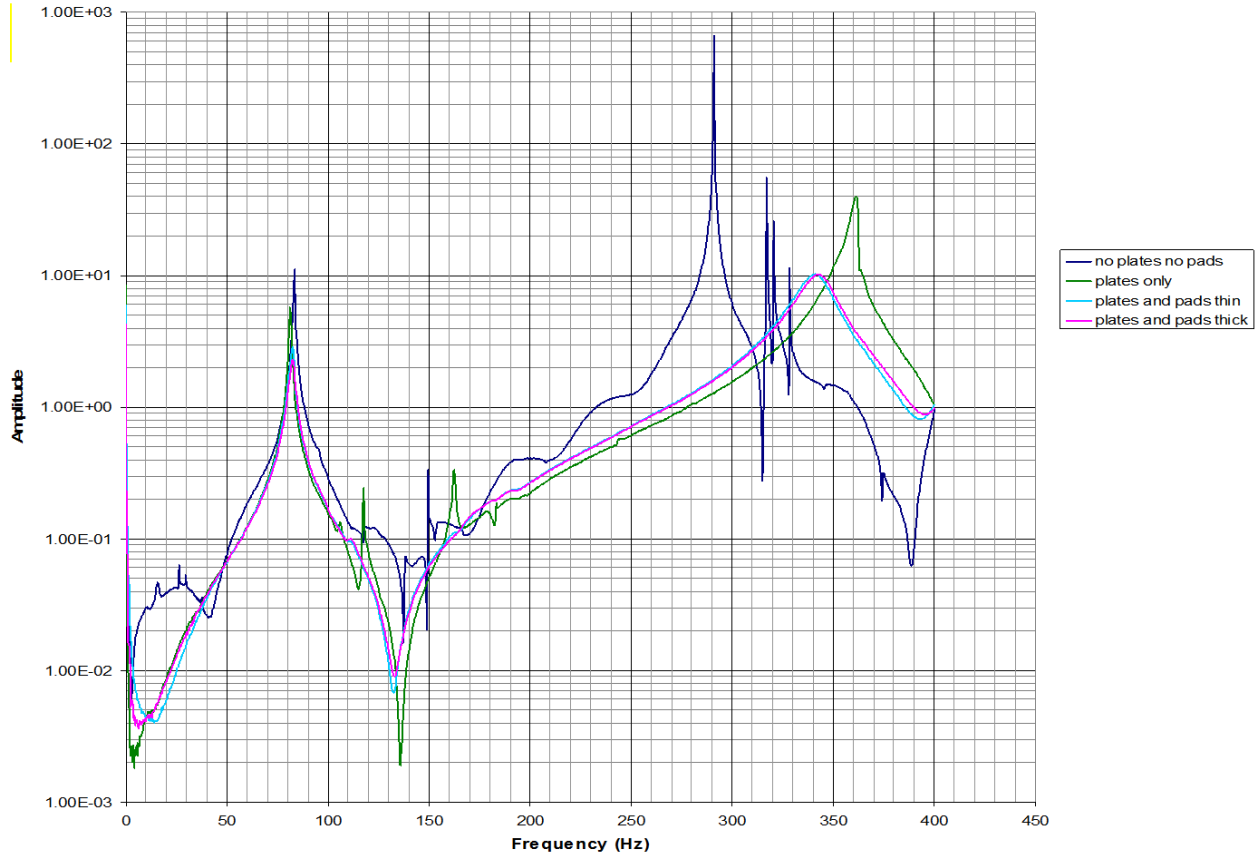

Figure 8

2.3 Vibration absorber

A vibration absorber is a device that is attached to a structure in order to damp the resonances. Vibration Energy is dissipated by the vibration absorber.

The difference between a vibration absorber and a classic tuned mass damper system, is that the frequency of the vibration absorber does not need to be tuned : the damping action is broadband and is going to be efficient on all the low frequency modes of the structure.

The Figure 9 shows an example of good result that we can obtain with a vibration absorber on the Quad.

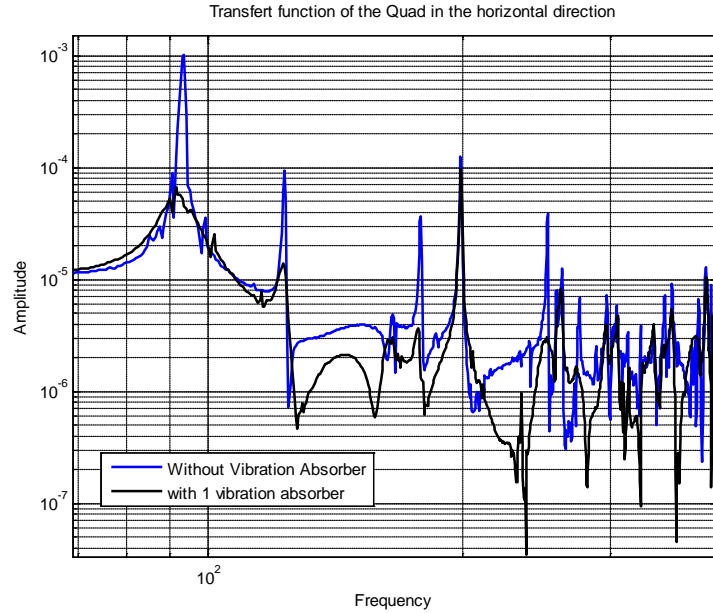

Figure 9

2.4 Conclusion

The table below summarizes the advantages and disadvantages of the three methods. The vibration absorber has been chosen for these good results and the low space it takes on the structure.

System	Advantages	Disadvantages
Struts	<ul style="list-style-type: none"> - Good damping of the mode by at least a factor of 3. - No creation of new modes. 	<ul style="list-style-type: none"> - Add a lot of mass on the global system. - Need improvement of the optic table of the ISI platform to attach it. - Difficulty to set up the device.
Corner brackets	<ul style="list-style-type: none"> - Good damping of some modes of the structure. - No creation of new modes. 	<ul style="list-style-type: none"> - Not able to damp all the modes of the system
Vibration absorber	<ul style="list-style-type: none"> - Excellent damping of the modes of the structure. - No creation of new modes. 	<ul style="list-style-type: none"> - Need several vibration absorbers to damp all the modes of the structure.

Table 1

3. Presentation of the chosen solution : the vibration absorber

3.1 Design

A mass spring system is made of a 4 lbs stainless steel mass and Viton© pads. It is put in a box, formed by two clamps, allowing the mobility of it. This system can be bolted on several locations on the structure, thanks to two fixation plates. The stress applied on the pads can be controlled by the use of precision washers.

More information about the vibration absorber assembly is in document LIGO #E1000133.

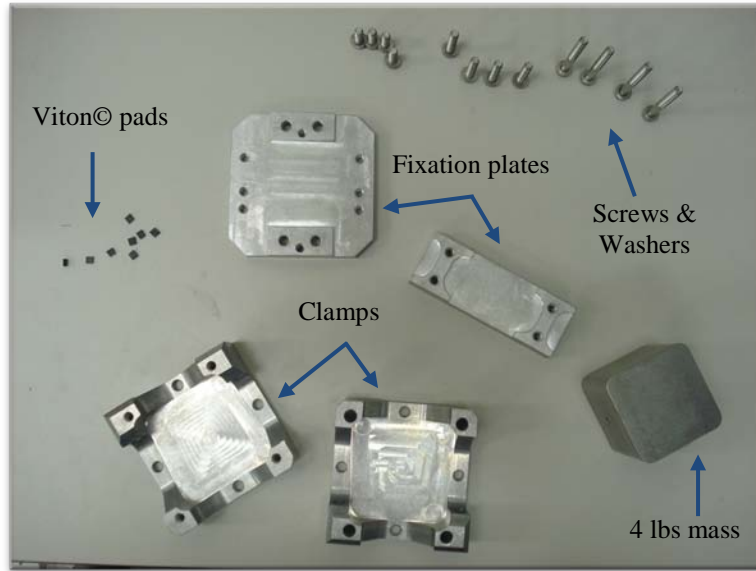

Figure 10

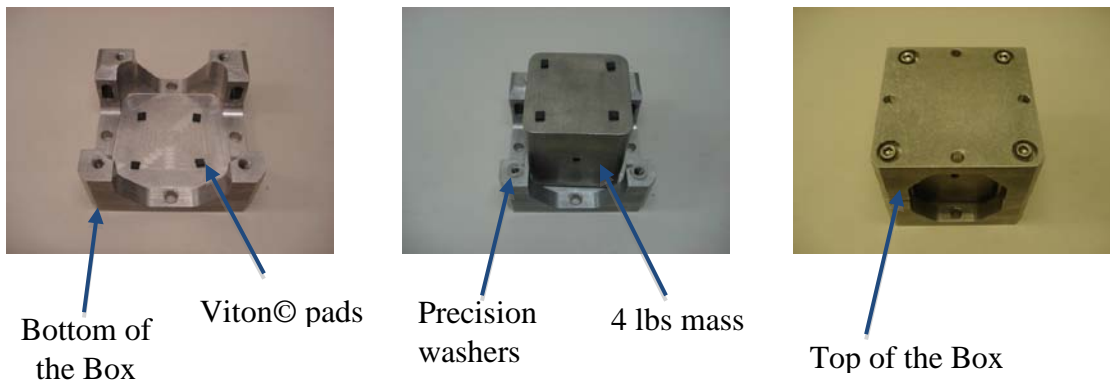
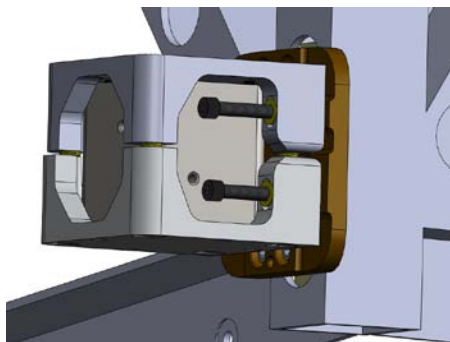

Figure 11

The absorber can be attached to via two configurations :

- Horizontal layer : the pads are on a vertical axe. The Viton© will work essentially in compression.
- Vertical layer : the pads are on a horizontal axe. The Viton© will work essentially in shear.



Configuration 1 : Viton© layer in the horizontal plan

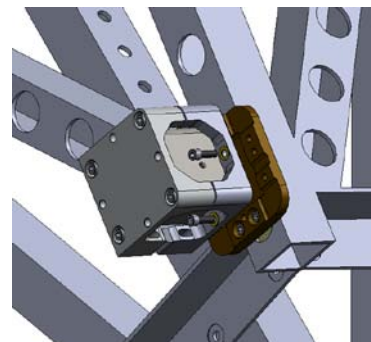

Configuration 2 : Viton© layer in the vertical plan

Figure 12

3.2 Results on the quad

The Quad transfer function shows a very high number of modes. These modes are one of the main limitations of performance for the BSC-ISI control.

3.2.1 Experiment presentation

All the experimentations are done in the air on a prototype. This prototype is only made with the Upper and the Lower structure, the internal structure is not available.

It would have been more realistic to attach the Quad on an optic table. However, the bench we were using for the preliminary testing is not anymore available. Thus, the Quad is suspended by four hooks to make a free structure analysis, as shown on the figure below. This configuration alters the analysis, but should allow to demonstrate the vibration absorber efficiency.

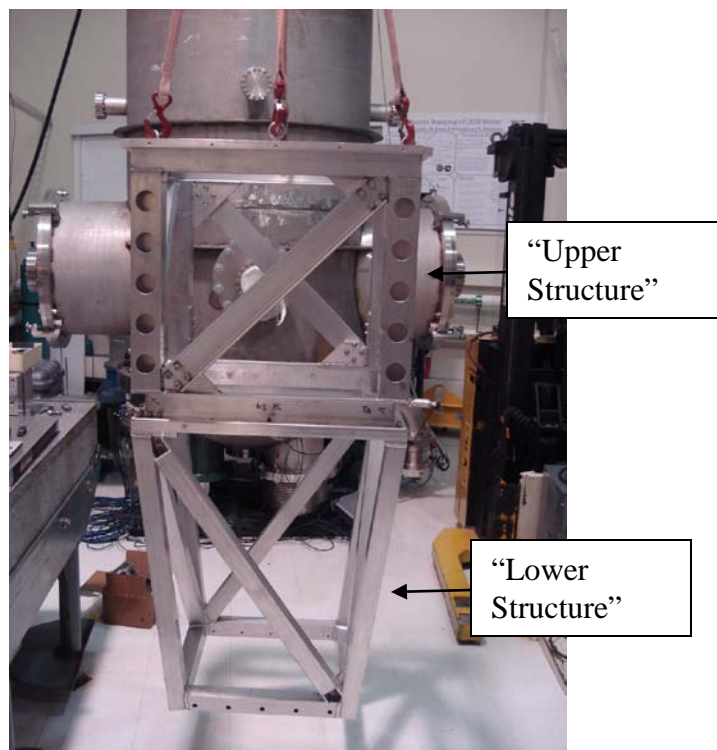

Figure 13

3.2.2 External transfer function

The modal analysis is done using an accelerometer on the Quad and an impact hammer with force sensor. The accelerometer is clamped on the upper structure. A choc is also applied on the upper structure.

Transfer functions of accelerometer response over the impact force are taken. The input/output points are shown on the picture above.

This configuration gives us a characteristic transfer function of the quad structure in the horizontal direction. The TF is made of 10 data averaging.

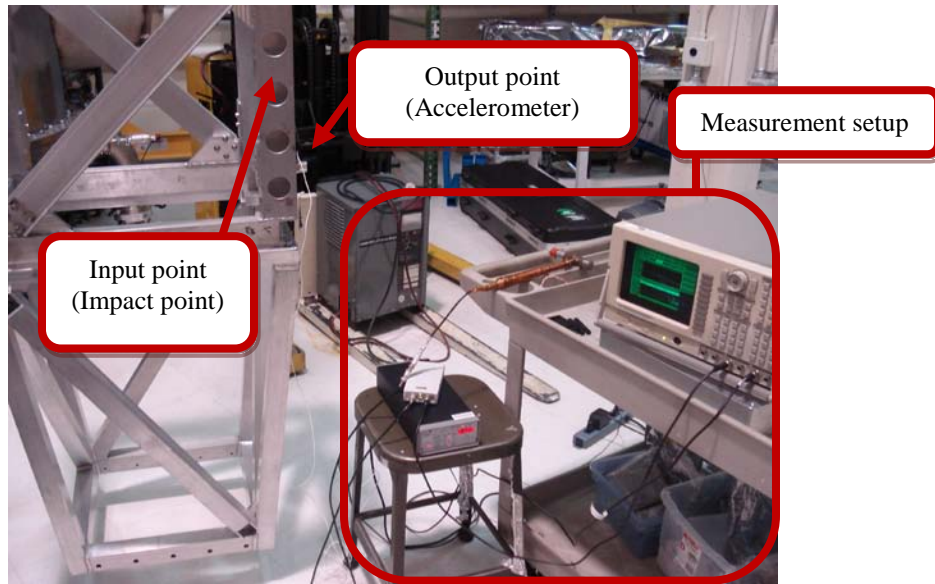
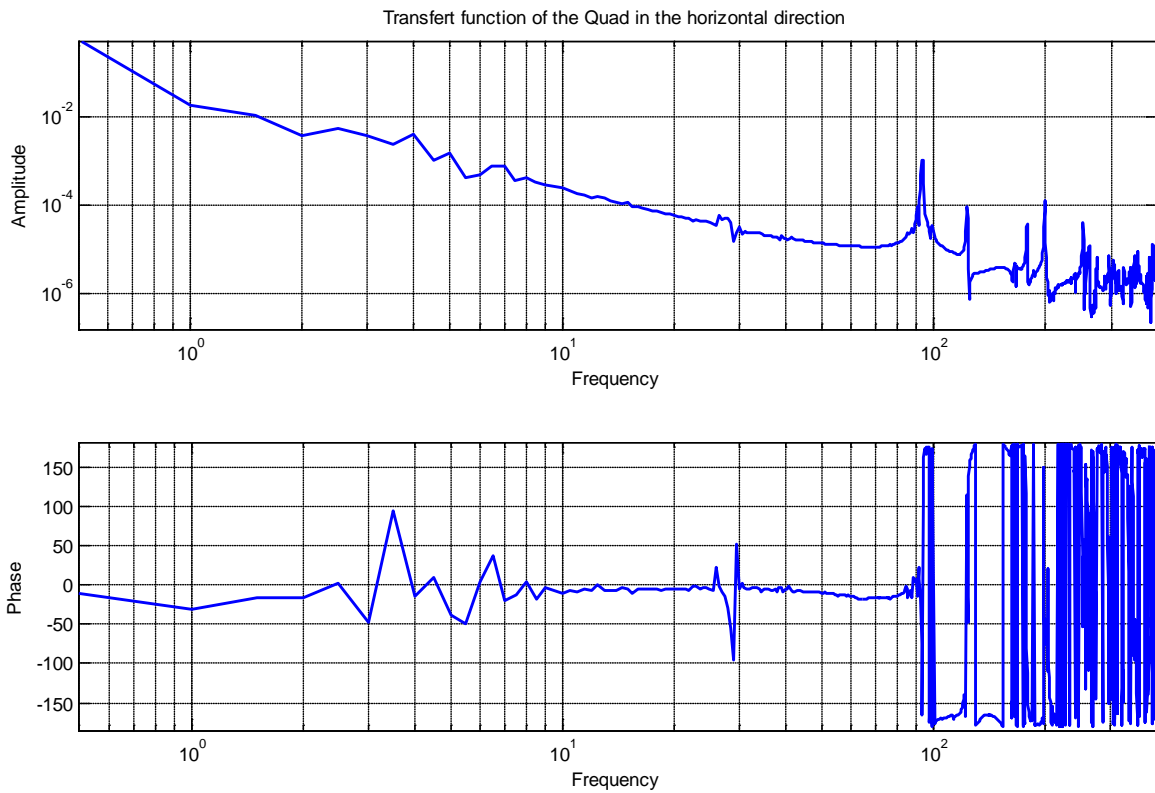
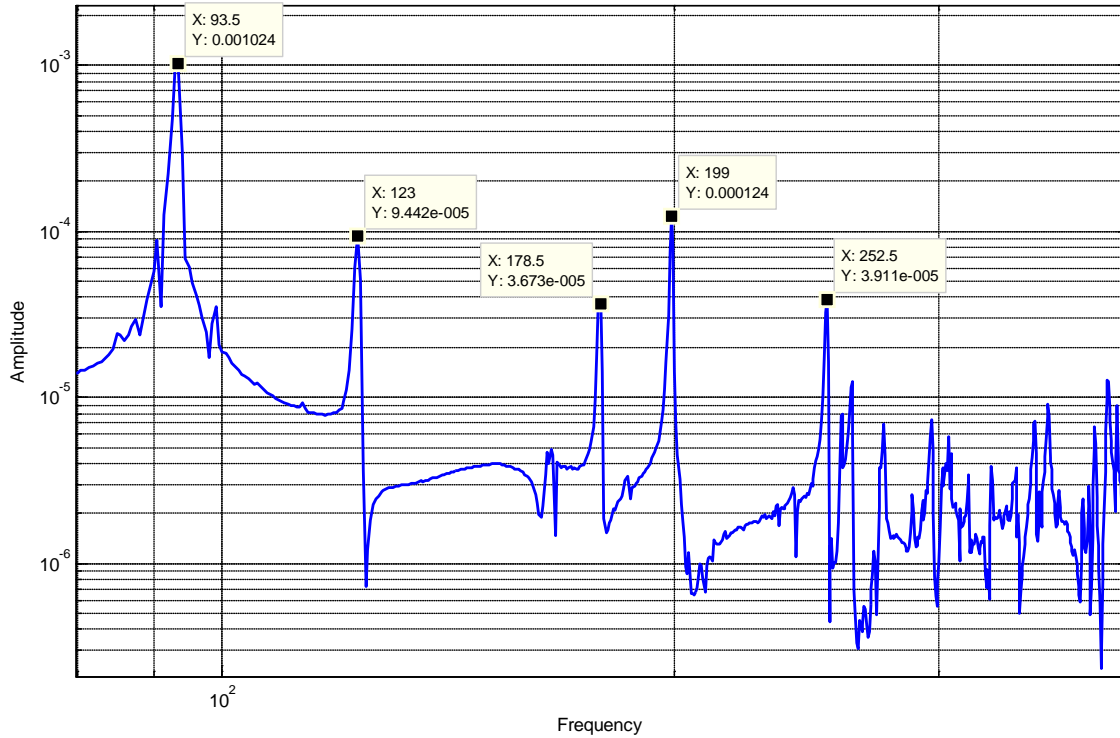

Figure 14





Figure

15
Figure 16

The prototype Quad structure presents five main modes between 90 Hz and 260 Hz. These modes are already damp by the air and must have a bigger Q factor in the vacuum. They are going to affect the general behavior of the BSC-ISI system.

3.2.3 Experiment with supported mass

Firstly, we use supported masses. A supported mass is a simple mass put on four pads of Viton®. With this solution we create a mass-spring system in the vertical direction. By trying different spots, this system allows to know the local modes of the structure, and thus optimize our work before using the vibration absorbers.

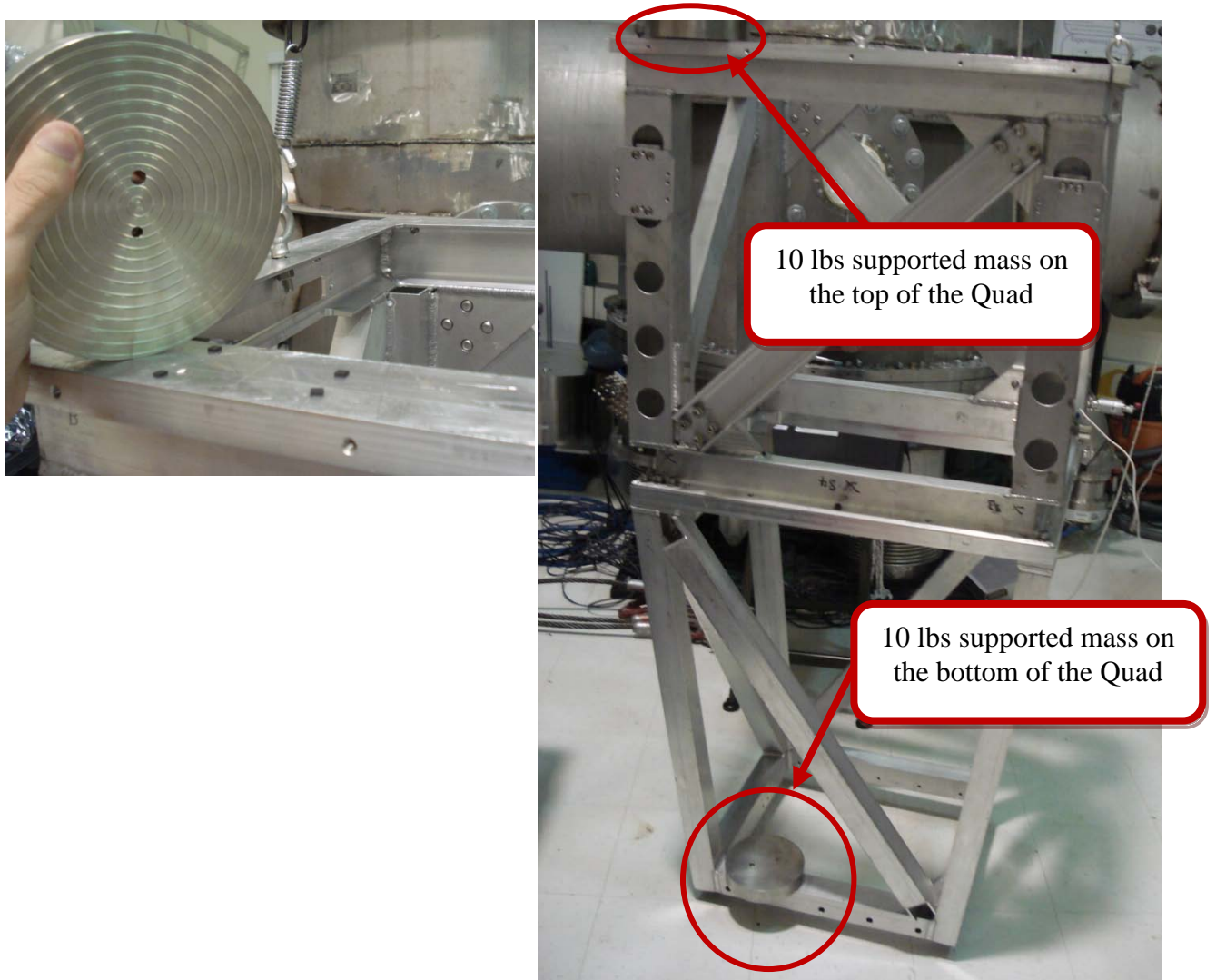

Figure 17

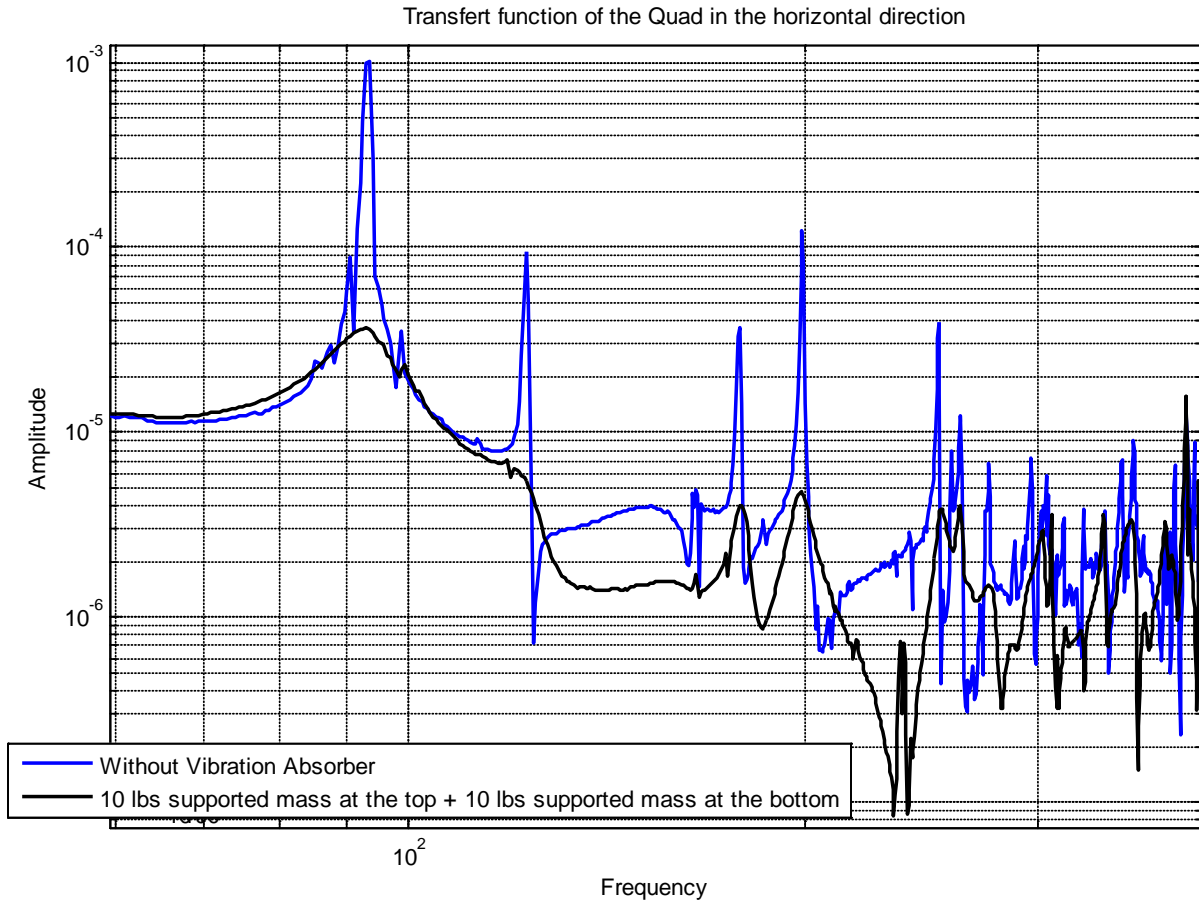

Figure 18

The results obtain with the supported masses are excellent : the goal is to adjust the parameters of the vibration absorber to have the same kind of results.

3.2.4 Experiment presentation with the vibration absorber

On the real structure, the vibration absorber must be attached on the lower part of the Quad, as shown in the precedent part of this document. In this suspended configuration experiment, we are not able to screw them at the bottom. The only sports available are on the sleeves of the upper part. The vibration absorber is attached on the Quad thanks to two plates (plate 1 + plate 2). Those two plates are screwed together through a sleeve of the quad.



Plate 1

+



Plate 2



Figure 19

The vibration absorber is attached on plate 2.



Configuration 1



Configuration 2

Figure 20

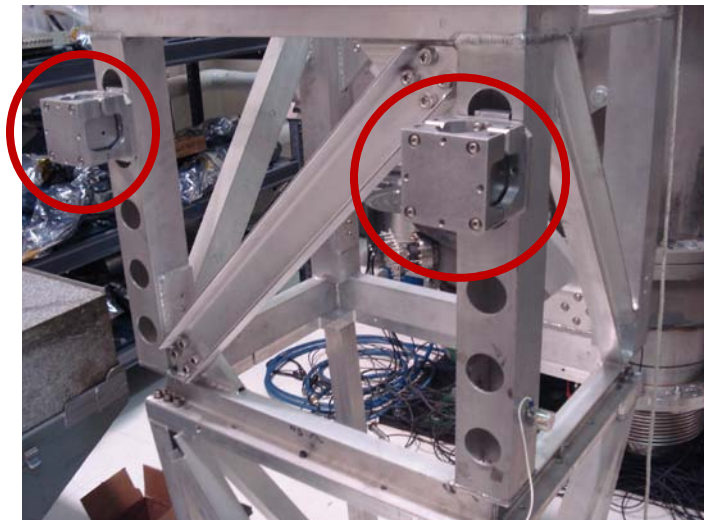

Figure 21

3.2.5 Quad external structure + vibration transfer function

The **Error! Reference source not found.** presents the transfer function of the Quad without absorber, with one absorber (two possible configurations: horizontal or vertical layer), and finally with two absorbers (three possible configurations : horizontal-horizontal, vertical-vertical or horizontal-vertical).

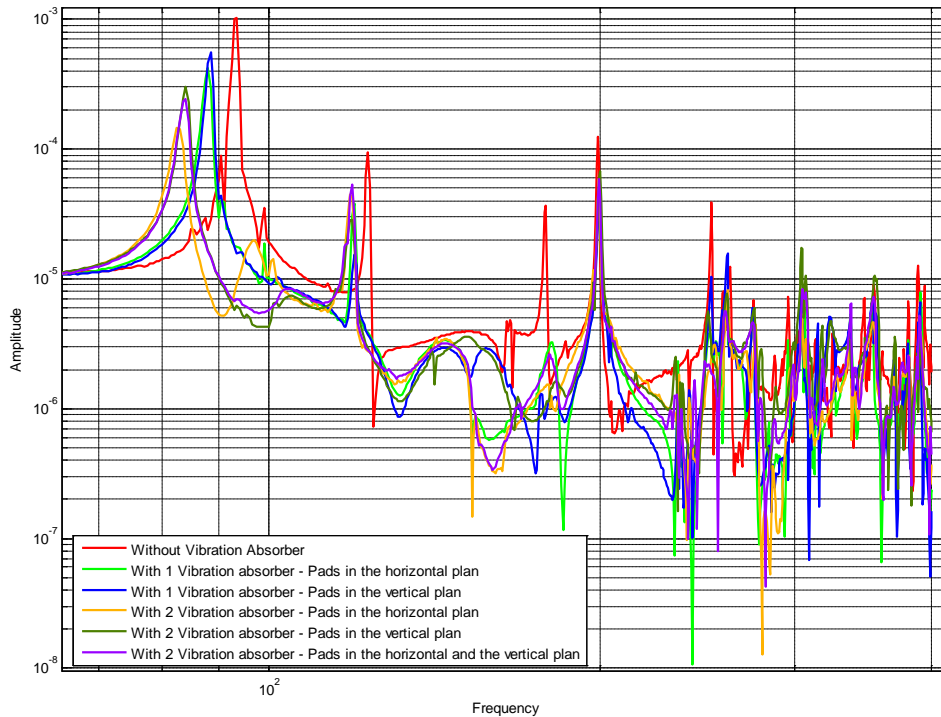

Figure 22

Without vibration absorber, we can see five modes between 100 Hz and 400 Hz (the mode at 60 Hz is due to the power supply). With one or two vibration absorbers, the first mode is very well damped. The fourth mode is not damp because it is due to the lower part of the Quad. The configuration with two vibration absorbers is too heavy, and the result is not so good : it creates a new mode. The best configuration is the use of one vibration absorber with pads in the horizontal plan : thanks to the vibration absorber, the mode at 103 Hz goes from a factor Q equal at 18 to a factor Q of 5.

But the results are not as good as they are with the supported masses. We need to adjust some parameters to improve the efficiency of the vibration absorber.

3.2.6 Adjustment of parameters

A vibration absorber is made with Viton© pads. Two main parameters are important to take care about concerning those pads :

- the size : each pad is going to have a definite size, which is going to influence the stiffness properties of the material.
- the constraint : the clamps of the vibration will impose a force on the pads, which can influence the efficiency of the damper.

Pads stiffness

The goal of this part is to observe the evolution of the damping effect of the vibration absorber with the stiffness of the pads. Three different sizes of Viton© are used.

Case 1 – “Nominal pads” – 8 pads, 0.18” square x 0.06” thick

Case 2 – “Stiff pads” – 16 pads, 0.18” square x 0.06” thick

Case 3 – “Soft pads” – 8 pads, 0.18” square x 0.24” thick



Nominal pads



Stiff pads



Soft pads

Figure 23

Only one vibration absorber is attached on the upper structure on the Quad, in the same configuration as previously. The three cases are tested with the pads in a horizontal plan.

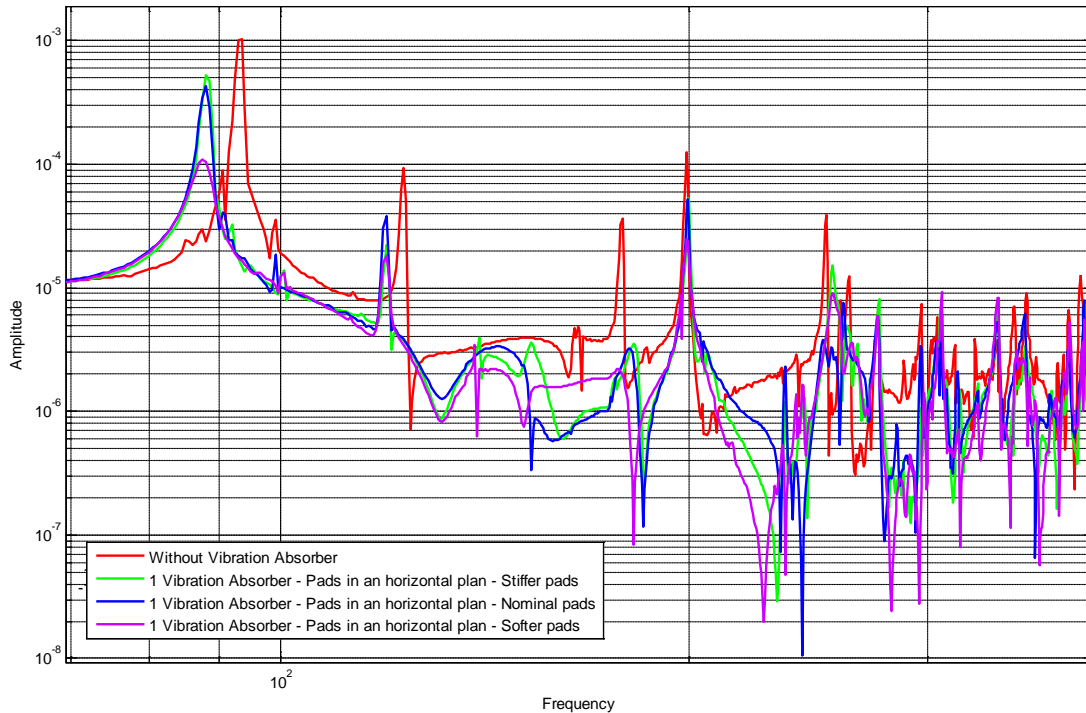

Figure 24

Soft pads allow the mass of the vibration absorber to have a motion most important in the box.

Constraint

We played with the preload applies on the mass by changing the numbers of washers between the two brackets of the vibration absorber. For this test, nominal pads are used, put in a horizontal plan

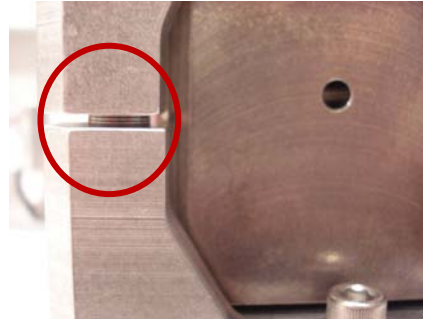

Figure 25

Figure 26 presents the transfer function of the Quad without absorber, with one absorber – 1 washer between the two clamps, with one absorber – 2 washers, and like that until 4 washers. After four washers, the mass is not handled anymore.

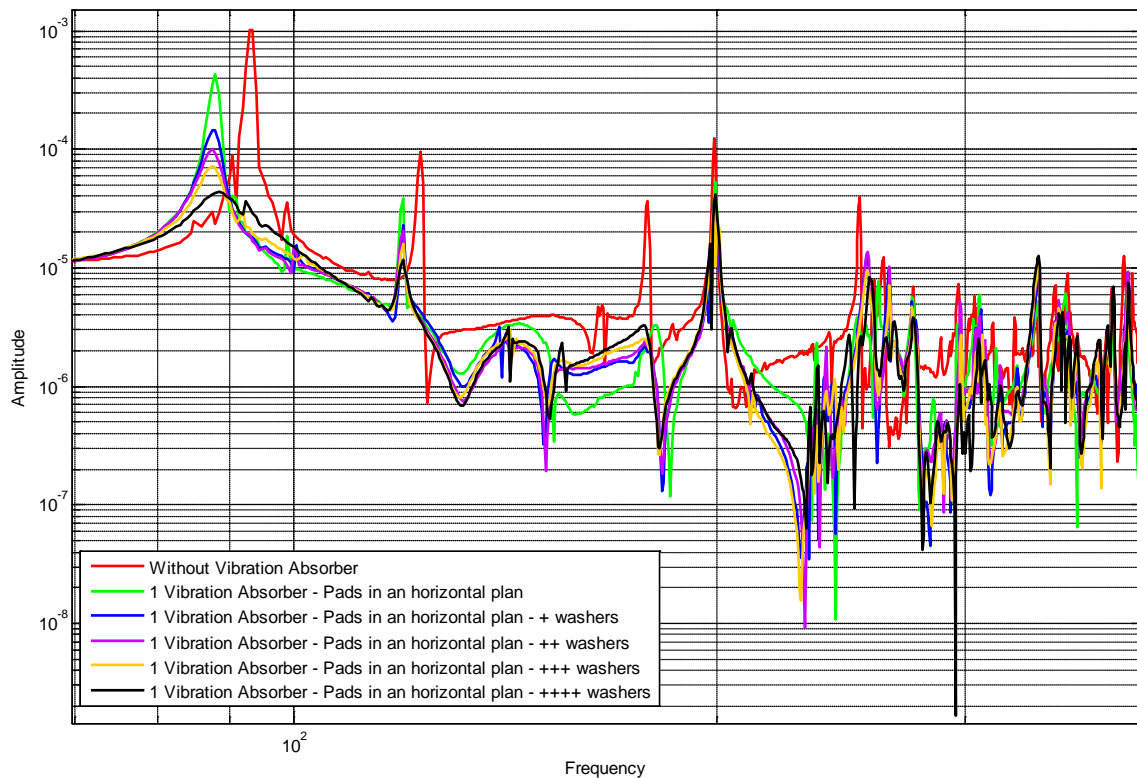

Figure 26

The constraint applies on the mass seems to be an important parameter. Too much constraint prevents the behavior of the mass and damps the efficiency of the vibration absorber. With few preload, we obtain results as good as the supported mass device on the Quad. One of the resonances is not damped because it is due to the lower part of the Quad.

3.3 Results on the HLTS

HLTS is typically a external structure made by steel beams, which shows some modes between 50 Hz and 200 Hz.

3.3.1 Experimental Presentation

All the experimentations are done in the air on a mock-up. To be realistic, this prototype is clamped to a bench via dog clamps.

3.3.2 Transfer function

The analysis is done using an accelerometer on the HLTS and an impact hammer with force sensor. The accelerometer is clamped on the top part of the structure, where we observe the most displacement. A choc is also applied on the top of the structure in two directions : in the longitudinal and in the transverse direction.

Transfer functions of accelerometer response over the impact force are taken. The input/output points are shown on the picture above.

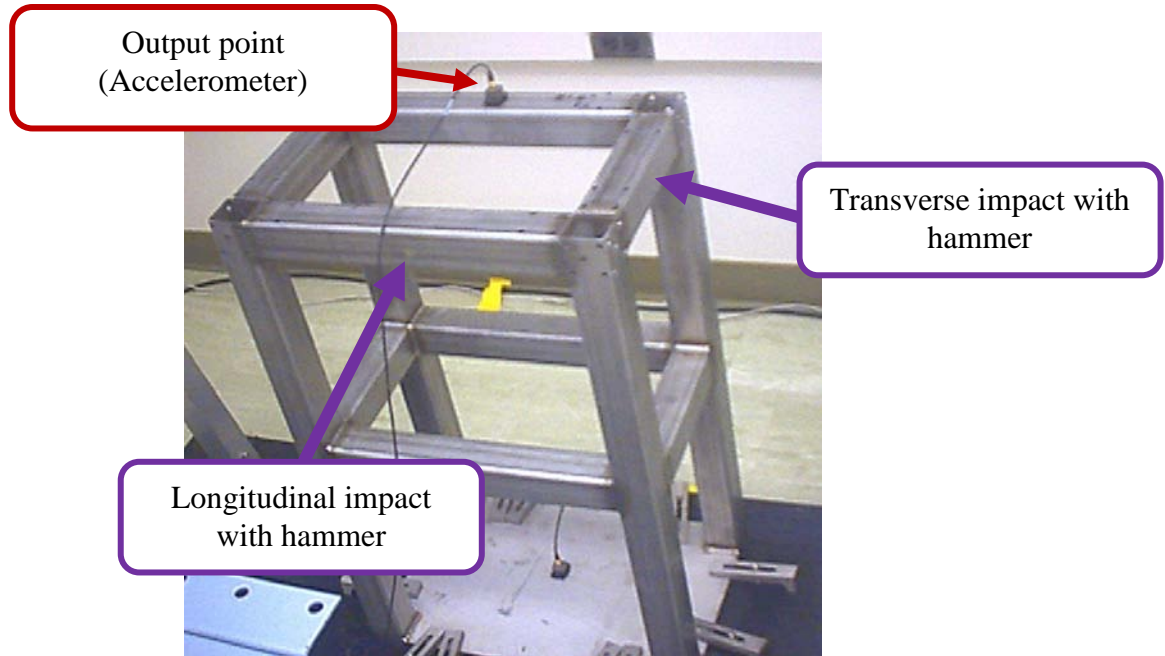

Figure 27

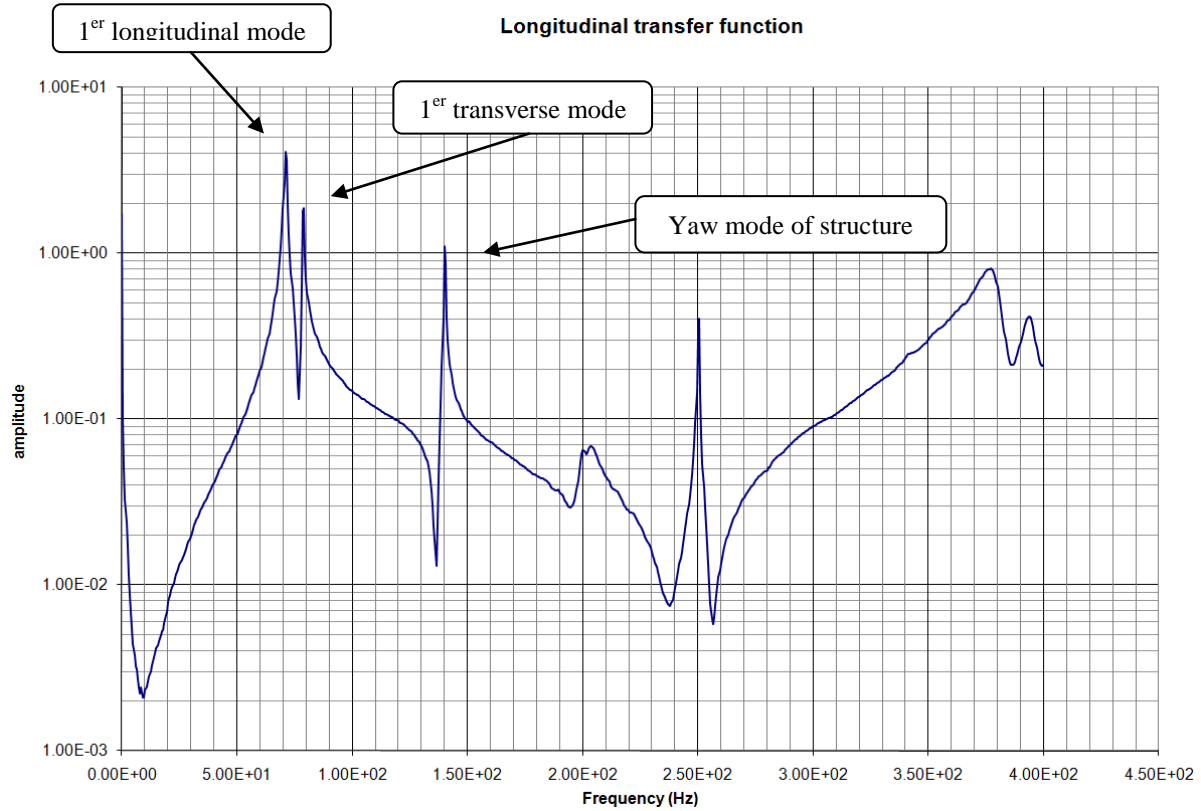

Figure 28

3.3.3 Experiment presentation with the vibration absorber

The test with vibration absorber has been done with two different thicknesses of Viton®.

Case 1 - "Two Stainless Vibration Absorbers" - 8 pads, 0.18" square x 0.06" thick

Case 2 - "Two Stainless Thicker Viton" - 8 pads, 0.18" square x 0.12" thick

It should be noted that all vibration absorbers were added to the top cross bar on the mock-up HLTS.

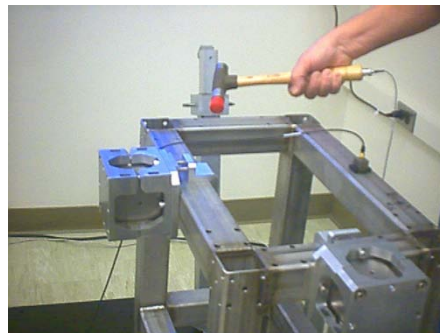
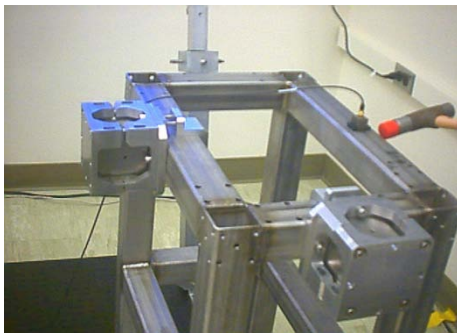

Figure 29

The Figure 30 presents the transfer functions of the HLTS without absorber, with one absorber (two possible configurations: horizontal or vertical layer), and finally with two absorbers. As well as a 4lb stainless steel absorber, we also tested an aluminum version, where the stainless steel block was replaced by an equivalent sized aluminum version.

Graph of Amplitude vs frequency - With and without various types of vibration absorbers, as indicated in table

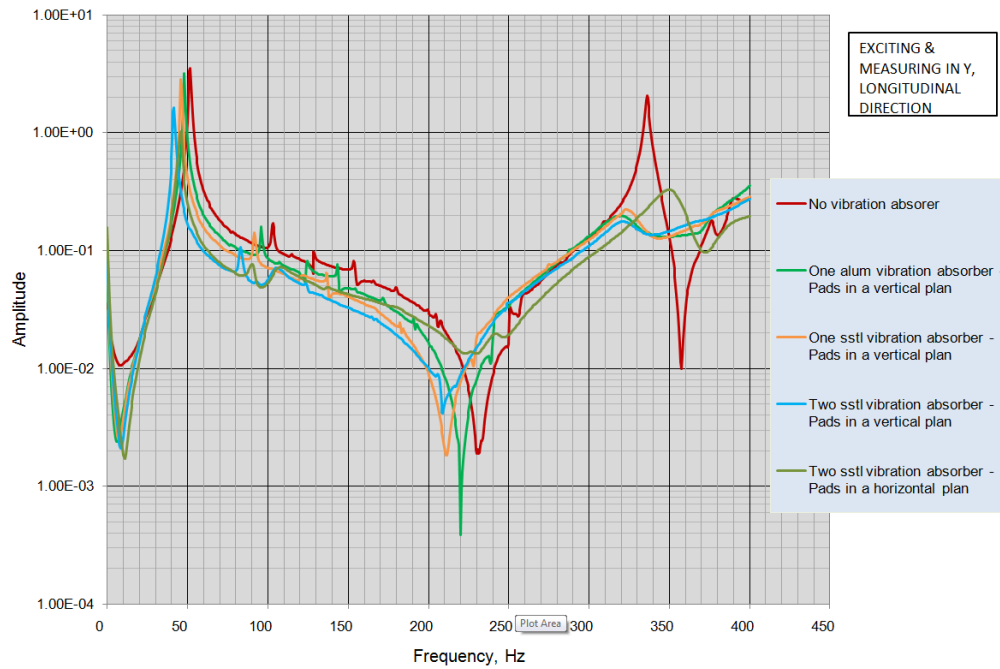

Figure 30

Without vibration absorber, we can see some modes between 50 Hz and 400 Hz. The aluminum mass seems to be too light to damp the modes. The best configuration is the use of two vibration absorbers with pads in the horizontal plan.

3.3.4 Adjustment of parameters

Constraint

The same type of experiment has been done on the HLTS. This time, we suppressed the load applied by the top clamp by removing it.

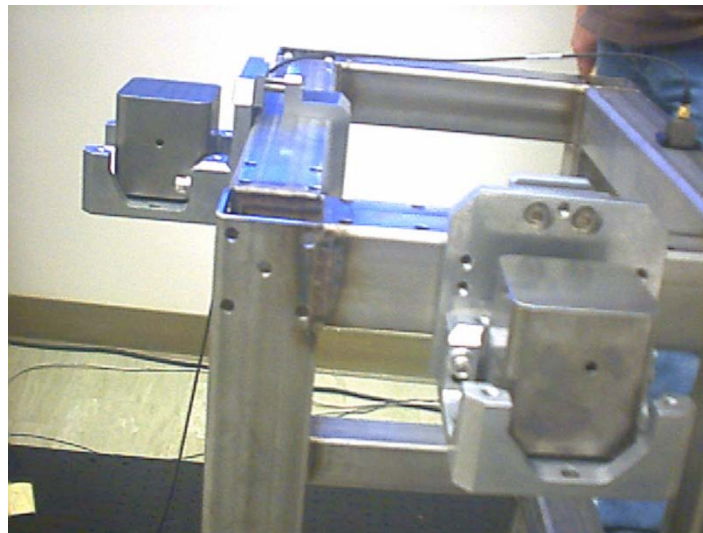

Figure 31

Graph of Amplitude vs frequency - With and without various types of vibration absorbers, as indicated in table

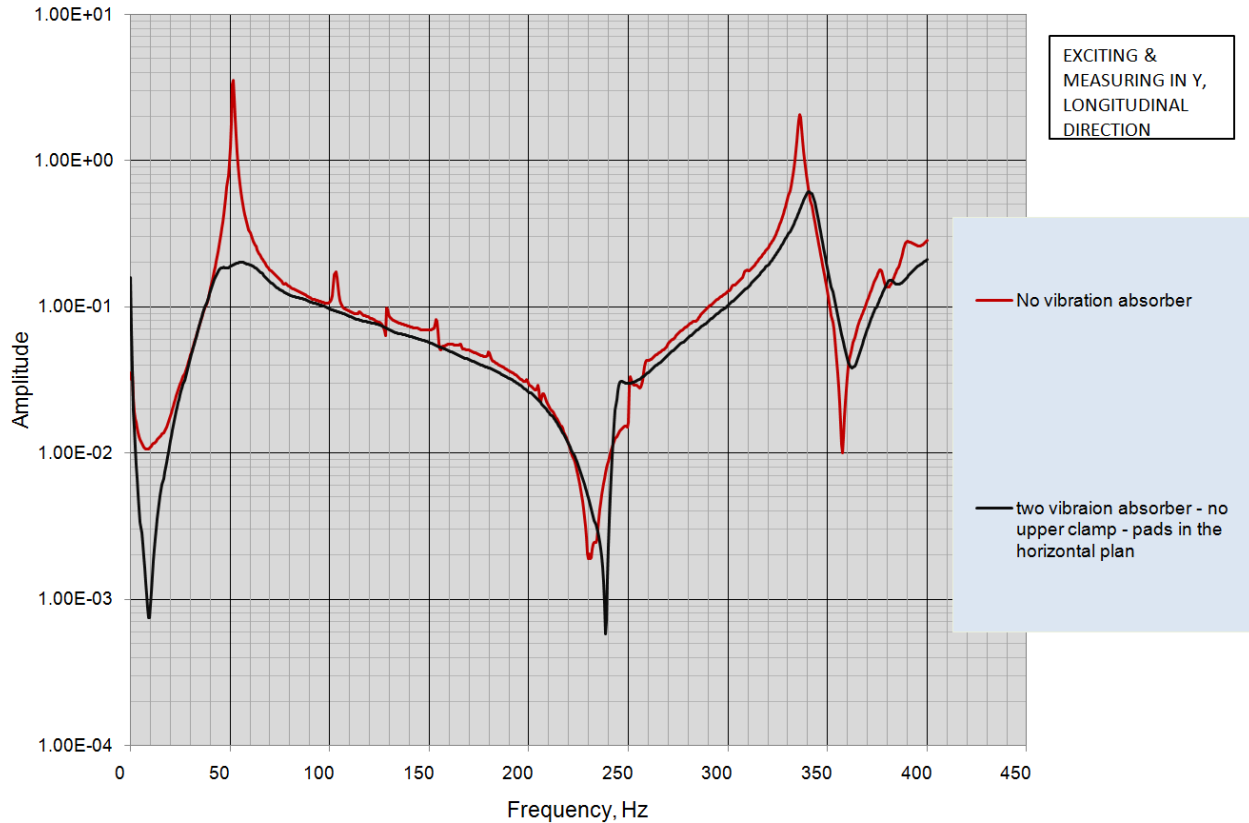

Figure 32

The constraint applies on the mass also seems to be an important parameter in this case. The idea is to find a good compromise between performances and stability of the mass between the brackets.

4. Layout

As given the good result obtained with the vibration absorber, this device is going to be installed on different structures, in different configurations. The document LIGO# [C1001399](#) gives the quantity of vibration absorbers required for each structure and an estimate cost.

5. Conclusion

The vibration absorber is able to significantly damp modes of the HLTS, OMC and structure in a passive way. It is simple, light and easy to install. However, one of the parameter we really need to take care about is the load apply on the top pads. To have a good efficiency, this load must be as small as possible. Thus, the next step is to redesign the vibration absorber for manage this parameter.