

LHO 4K IOO WFS 1

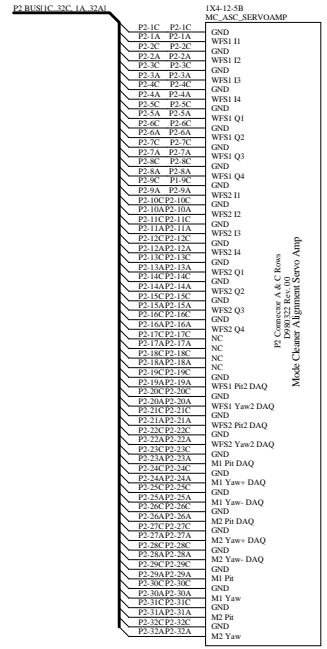

LHO 4K MMT3 Opt Lever PD

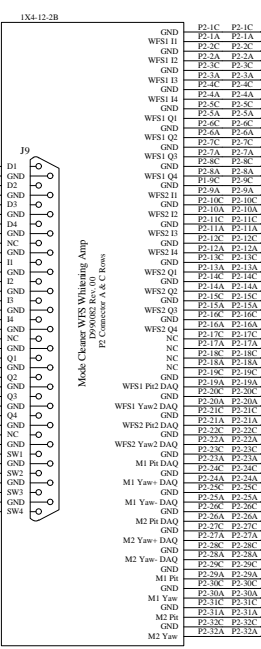
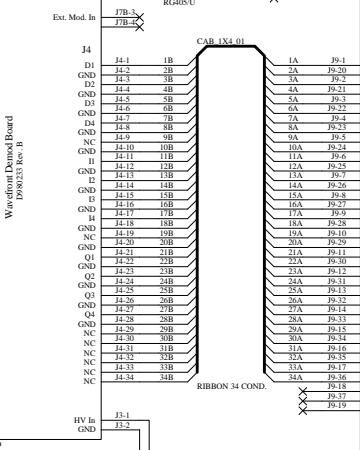
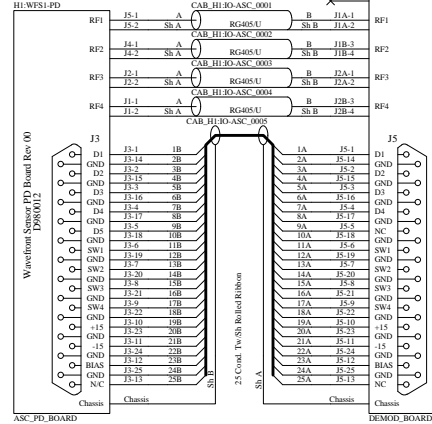
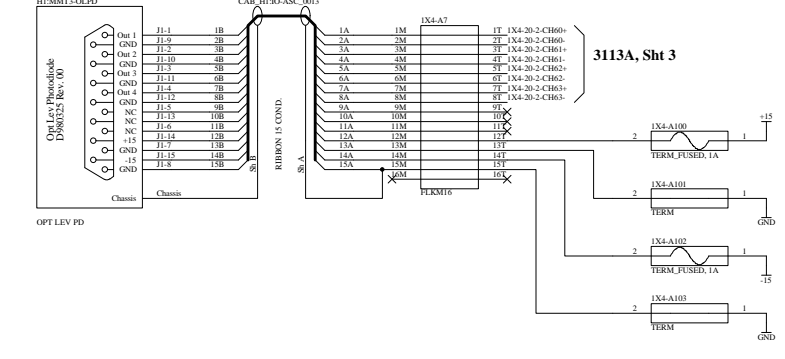

LHO 4K MMT3 Opt Lever Laser Diode

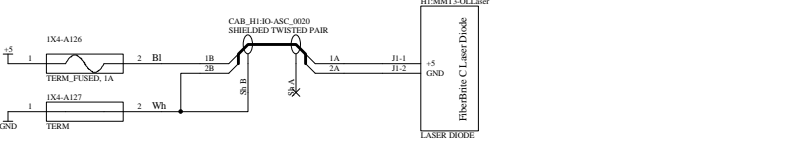

LHO 4K IOO WFS 2

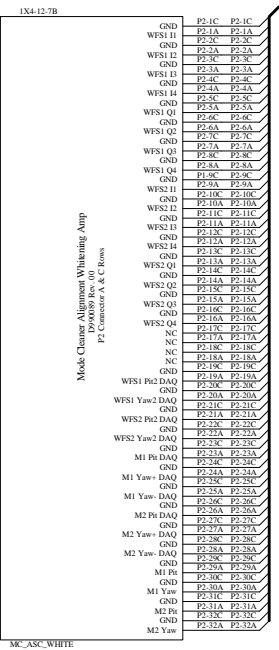
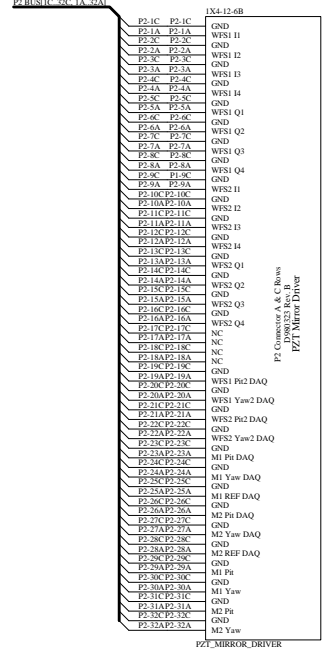
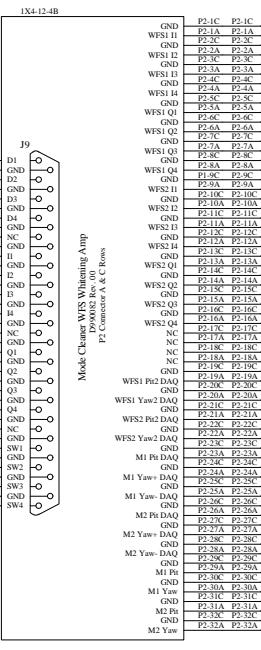
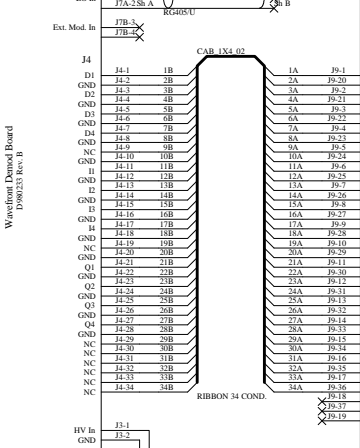
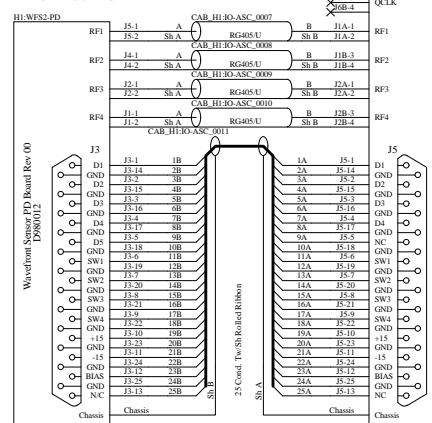

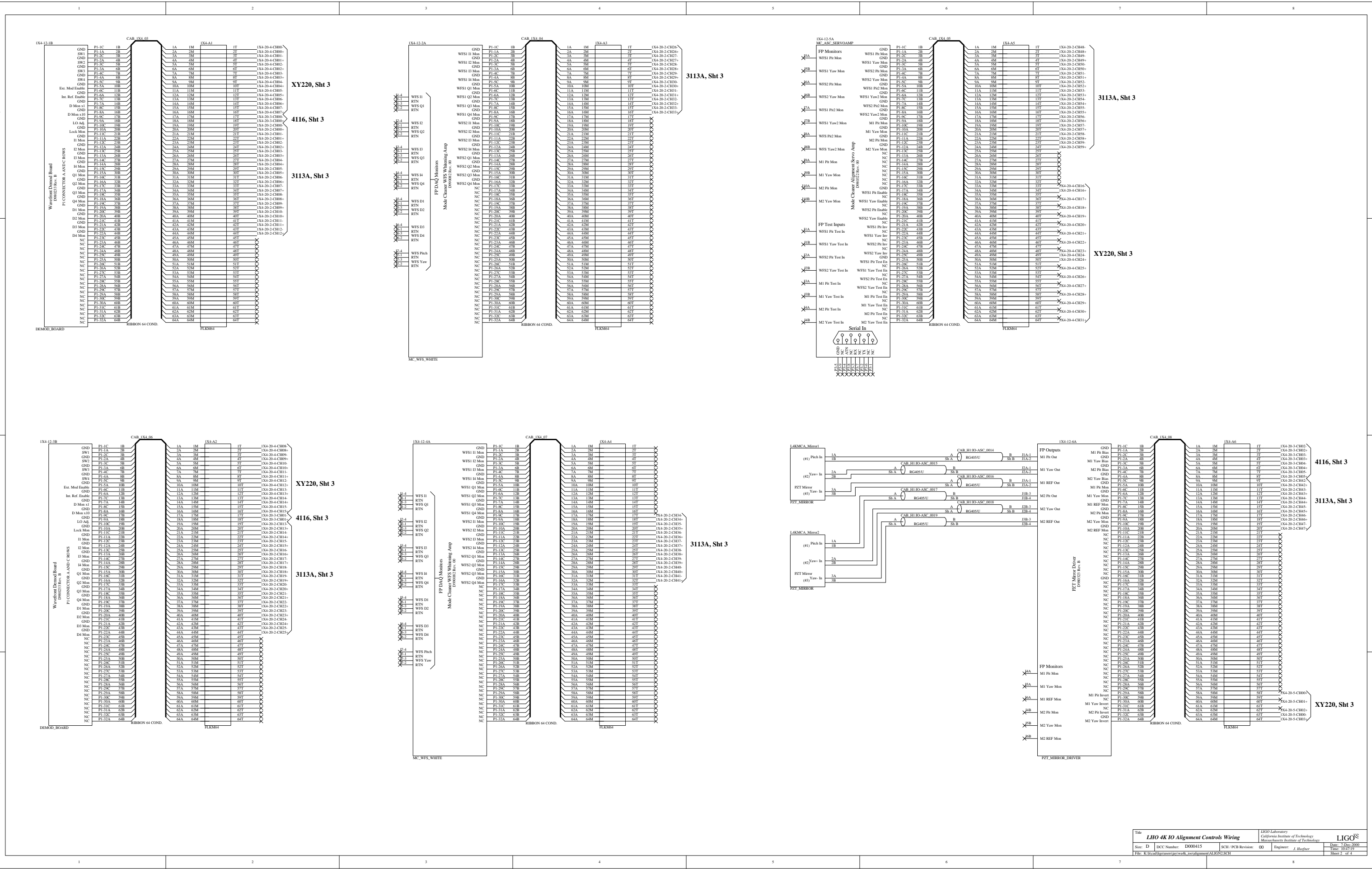

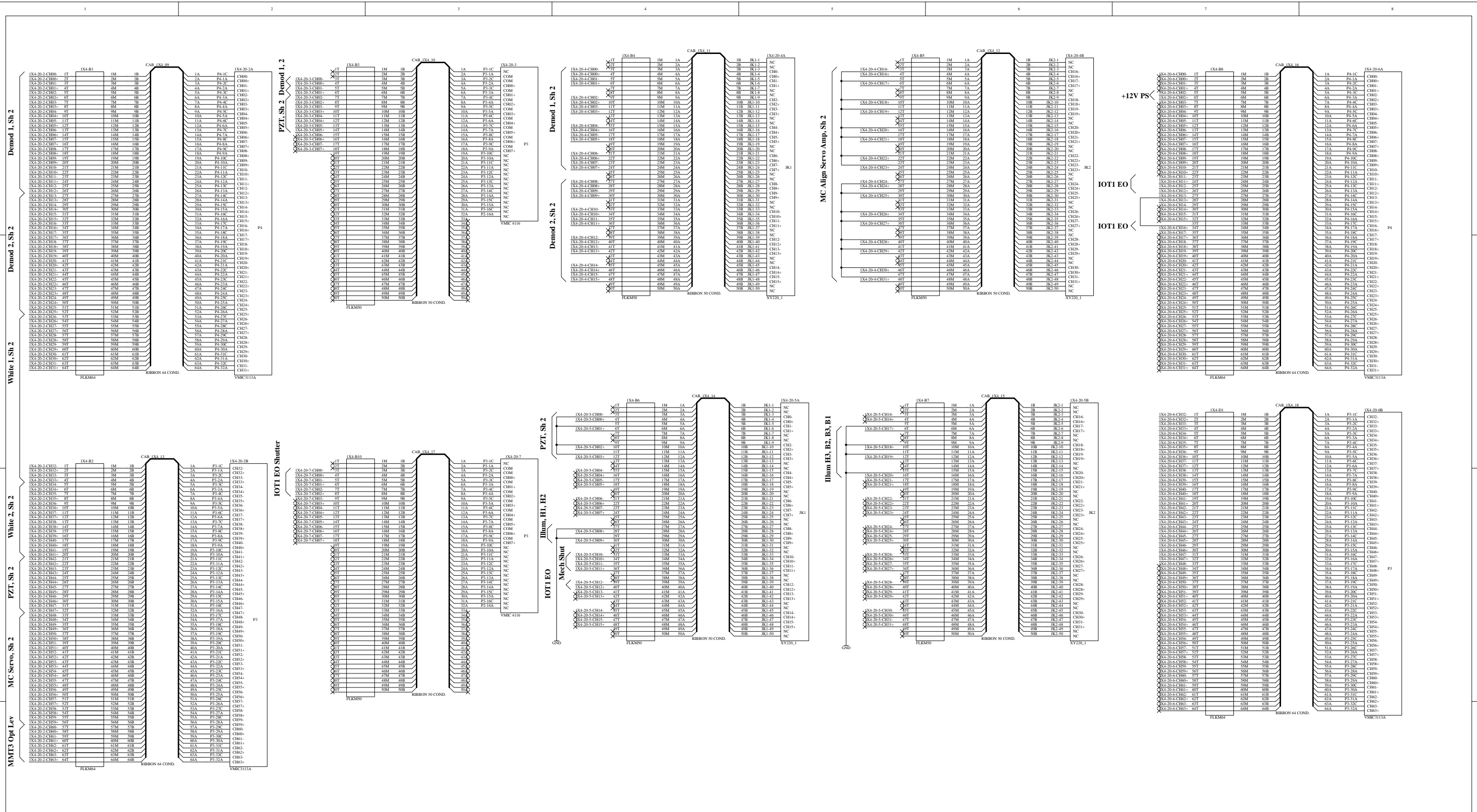

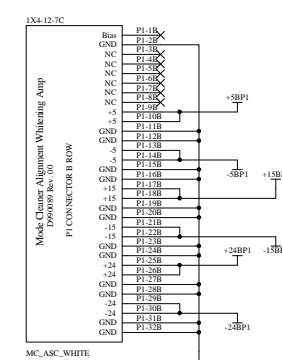
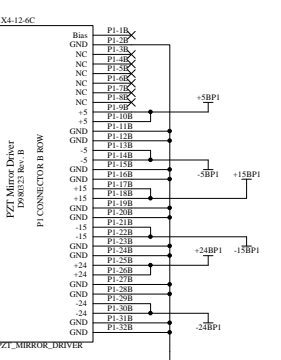
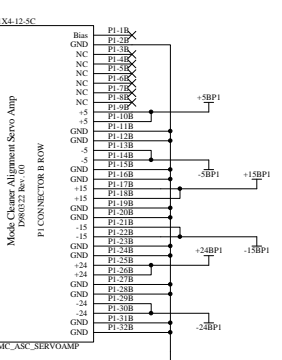
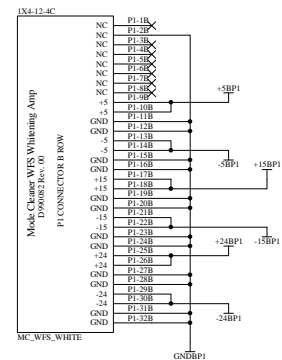
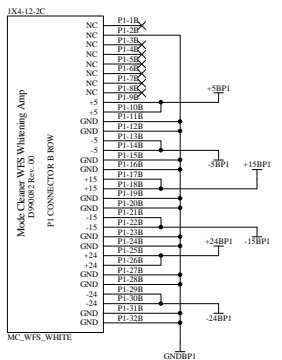
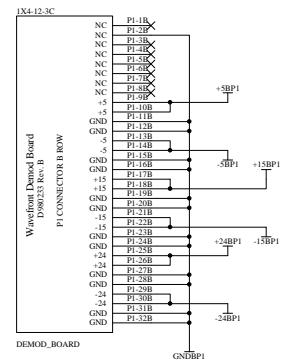
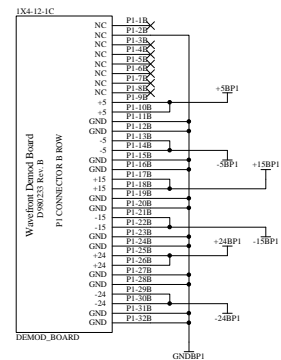

Note:  
Power Connections for Eurocard modules are made through the backplane and are designated as XXBP1. Bulk power supply connections to the eurocard backplane lugs are designated +XX.

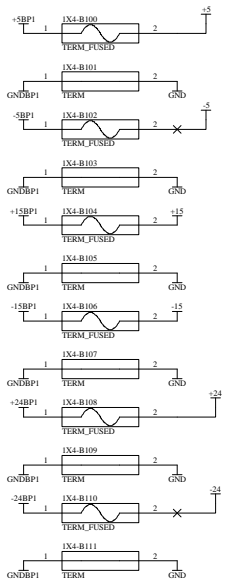

WFS PD-100 VDC Bias Supply

