

CNRS

Centre National de la Recherche Scientifique

INFN

Istituto Nazionale di Fisica Nucleare

**40 Meter Focal Length Zoom Objective Lens
For
Optical Lever System -Position Memory**

M. R. Smith

VIR-NOT-CAS-1390-211

Issue: 01

Date: 13/06/2002

LIGO-T020203-00-D

VIRGO * A joint CNRS-INFN Project

Project Office: Traversa H di Via Macerata - Santo Stefano a Macerata, -56021 Cascina, Italia.

Secretariat: Telephone (+39) 050 752 521 * FAX (+39) 050 752 550 * e-mail: virgo@virgo.infn.it



	40 Meter Focal Length Zoom Objective Lens For Optical Lever System -Position Memory	Date 13-06-2002 VIR-NOT-LAS-1390-211 page 2
---	--	---

Table of Contents

Table of Contents	2
Figures	2
1 Introduction	3
2 Optical Lever System	3
2.1 Beam Displacement Measurement System	3
2.2 Angle Measurement System.....	4
3 Design for a 40m EFL, Zoom Objective Lens	4
3.1 Mechanical Layout	4
3.2 Effective Focal Length	6
3.3 Angular Range.....	7
3.4 Focus Sensitivity	7
3.5 Cross-coupling Between Beam Displacement and Angle Measurement	9
3.6 Focussing Method	9

Figures

Figure 1: LIGO I Optical Lever Schematic	3
Figure 2: Angle Measuring Optical Lever System	4
Figure 3: Mechanical Layout of 40m Zoom Objective Lens.....	5
Figure 4: Effective Focal Length of Zoom Objective Lens.....	6
Figure 5: Effective Focal Length for -5mm and +5mm Extreme Rays	7
Figure 6: Angular Range of Zoom Objective Lens	8
Figure 7: QPD Spot Size Vs Defocus Distance of Front Zoom Lens	8
Figure 8: QPD Angular Signal Due to Lateral Displacement of the Optical Lever Beam.....	9
Figure 9: Cross-coupling Vs Defocus Distance of Front Zoom lens	10

	40 Meter Focal Length Zoom Objective Lens For Optical Lever System -Position Memory	Date 13-06-2002 VIR-NOT-LAS-1390-211 page 3
---	--	---

1 Introduction

The purpose of this note is to present a preliminary design of a 40 meter focal length, zoom objective lens for use in a displacement-insensitive optical lever system.

2 Optical Lever System

2.1 Beam Displacement Measurement System

An optical lever system is used in the LIGO interferometer for recording the angular positions of the main interferometer mirrors (core optics) and for auxiliary damping. The current design (LIGO I) utilizes the reflection of a collimated laser beam from the core optic onto a quad photodiode (QPD), as shown in Figure 1: LIGO I Optical Lever Schematic. The angular sensitivity is dependent upon the length of the lever arm from the mirror to the QPD and the minimum detectable displacement on the QPD. With a typical lever arm length of 5000mm and a minimum detectable displacement of 0.010mm, the angular resolution is approximately 2 microrad.

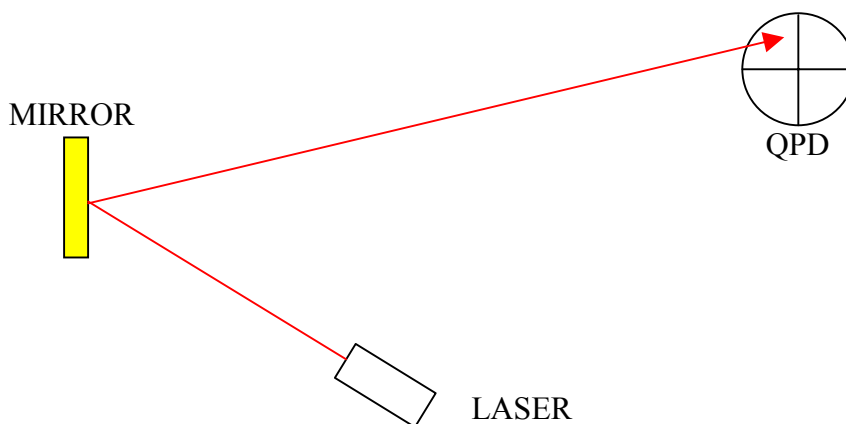



Figure 1: LIGO I Optical Lever Schematic

There are several drawbacks to this arrangement:

- 1 the sensitivity depends upon the length of the lever arm between the mirror and the QPD
- 2 the optical lever measures both angular displacement and lateral displacement of the beam; and for situations where the laser projector makes a large angle with respect to the normal to the mirror, the cross-coupling between axial displacement of the mirror and the angular displacement can be problematically large.

	40 Meter Focal Length Zoom Objective Lens For Optical Lever System -Position Memory	Date 13-06-2002 VIR-NOT-LAS-1390-211 page 4
---	--	---

2.2 Angle Measurement System

The optical lever system can be made to measure only angular displacement of the reflected beam by placing the QPD at the focal plane of an objective lens, as shown in Figure 2: Angle Measuring Optical Lever System.

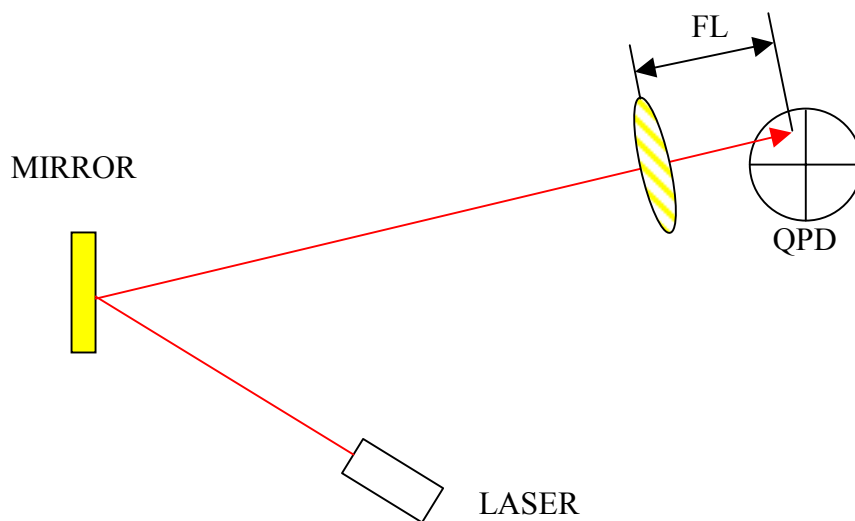

Figure 2: Angle Measuring Optical Lever System

The angular resolution of the optical lever system is proportional to the focal length of the lens, and inversely proportional to the minimum detectable displacement on the QPD. In order to achieve the same angular resolution as the previous displacement measuring system, the focal length of the lens must be 5000mm; a better resolution can be obtained with a longer focal length.

3 Design for a 40m EFL, Zoom Objective Lens

3.1 Mechanical Layout

A mechanical layout for a 40m EFL, zoom objective lens is shown in Figure 3: Mechanical Layout of 40m Zoom Objective Lens. The total length is approximately 11 inches.

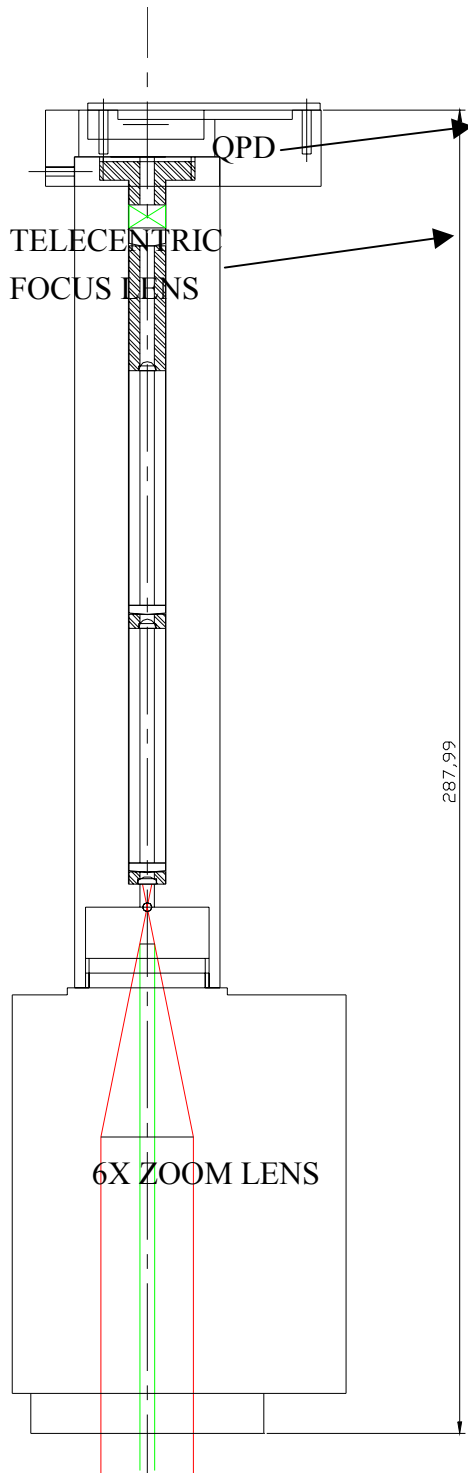



Figure 3: Mechanical Layout of 40m Zoom Objective Lens

	40 Meter Focal Length Zoom Objective Lens For Optical Lever System -Position Memory	Date 13-06-2002 VIR-NOT-LAS-1390-211 page 6
---	--	---

The front element is a commercial motorized zoom lens with variable focal length 8mm to 48mm, which is combined with a collimating lens to form a 6X afocal telescope. Two additional beam-reducing afocal telescope stages follow, to increase the angular magnification. Finally, the beam is focussed by a telecentric lens with the QPD placed at the focal plane of the lens.

3.2 Effective Focal Length

The effective focal length of the lens system can be varied from 6800m to 41000m by varying the focal length of the front zoom lens from 8mm to 48mm, as shown in Figure 4: Effective Focal Length of Zoom Objective Lens.

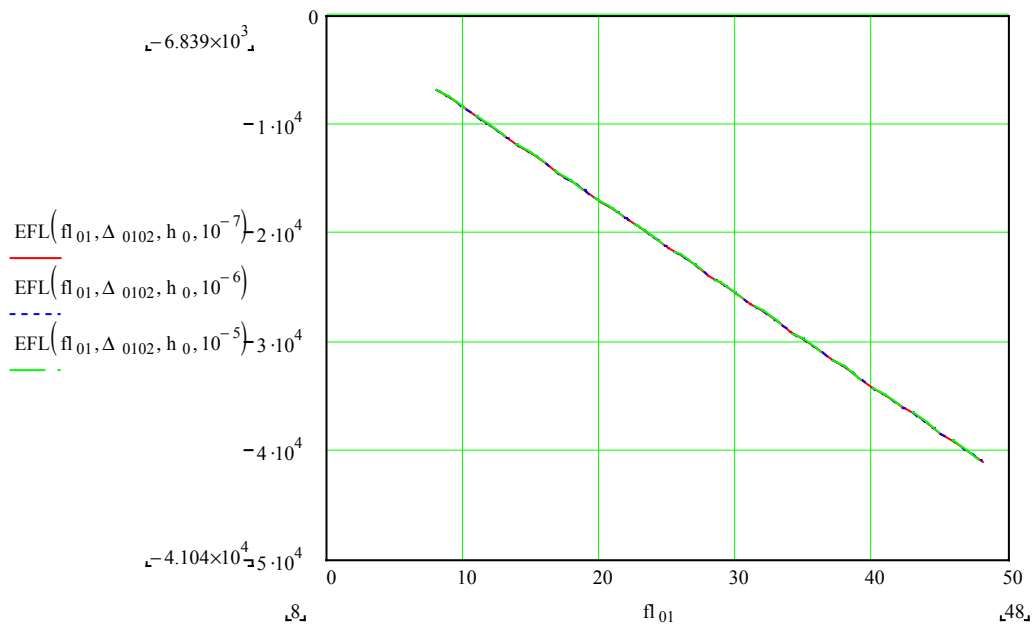

Figure 4: Effective Focal Length of Zoom Objective Lens

The zoom objective lens design functions well with a ray bundle of 10mm diameter, as shown in Figure 5: Effective Focal Length for -5mm and $+5\text{mm}$ Extreme Rays. The upper dashed curve is the effective focal length for the $+5\text{mm}$ offset ray; the middle curve is the central ray; and the solid curve is the -5mm offset ray. The effective focal length is essentially constant across the entire ray bundle.

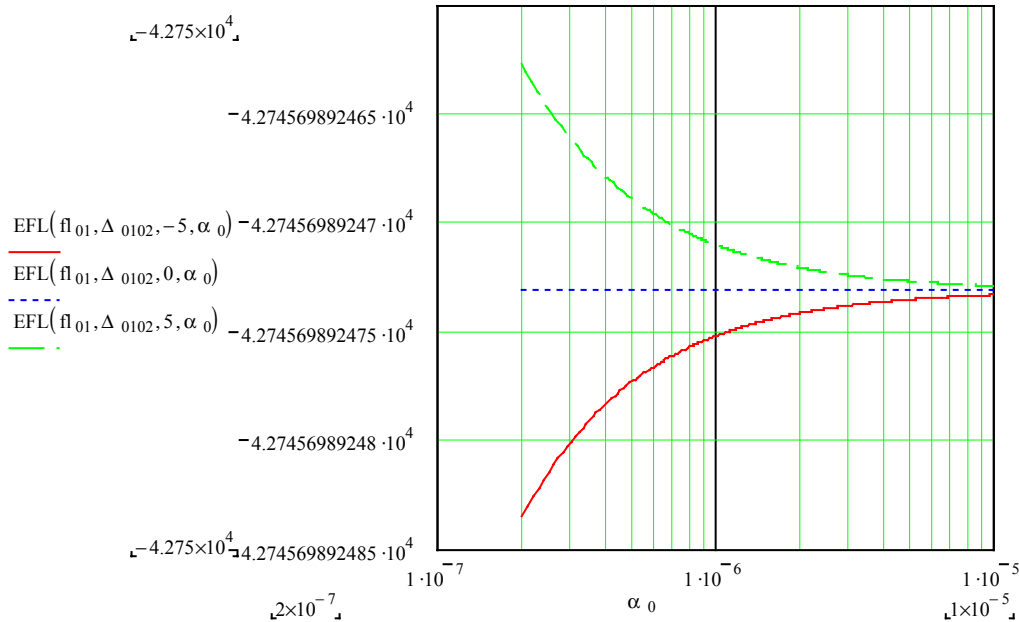

Figure 5: Effective Focal Length for -5mm and +5mm Extreme Rays

3.3 Angular Range

The usable angular range of the zoom objective lens is shown in Figure 6: Angular Range of Zoom Objective Lens. It extends from a minimum angular resolution of approximately 0.2 microrad with the zoom lens at 8mm--determined by the minimum resolvable displacement of 0.01mm of the QPD, to a maximum angle of 1 mrad with the zoom lens at 48mm--determined by the 10mm usable diameter of the QPD.

3.4 Focus Sensitivity

The focus of the front Zoom lens is quite sensitive for the short focal length zoom setting, as shown in Figure 7: QPD Spot Size Vs Defocus Distance of Front Zoom Lens. In order to restrict the size of the focussed spot on the QPD surface to less than 5mm, the de-focus distance between the input zoom lens's back focal plane and the focal plane of the first collimating lens must not vary by more than +/- 0.01mm for the case of the 8mm zoom setting, and must be less than +/- 0.07mm for the case of the 48mm zoom setting.

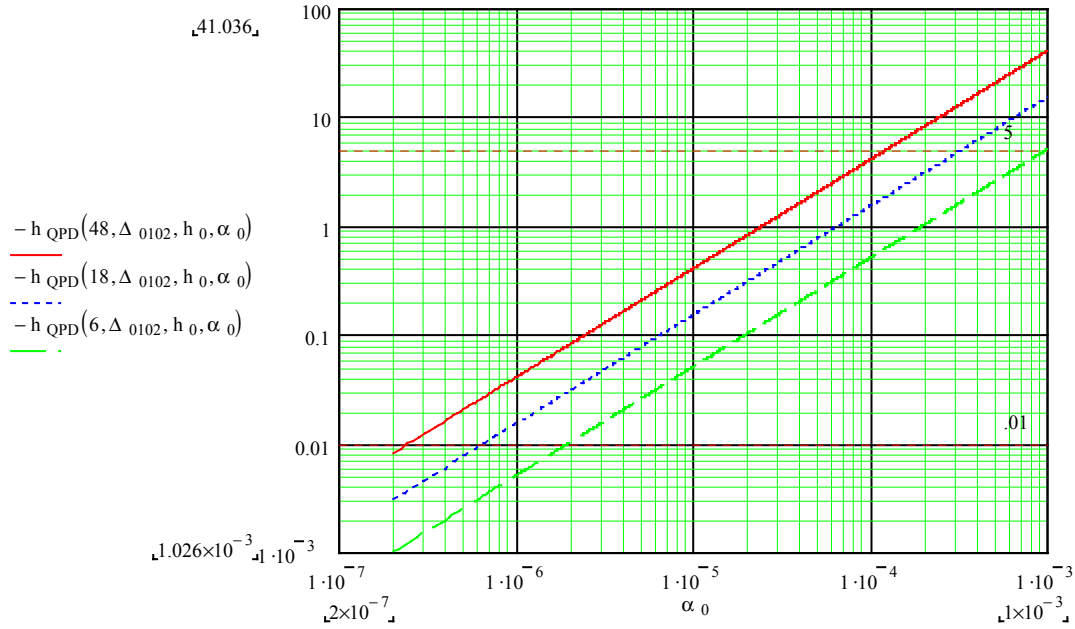

Figure 6: Angular Range of Zoom Objective Lens

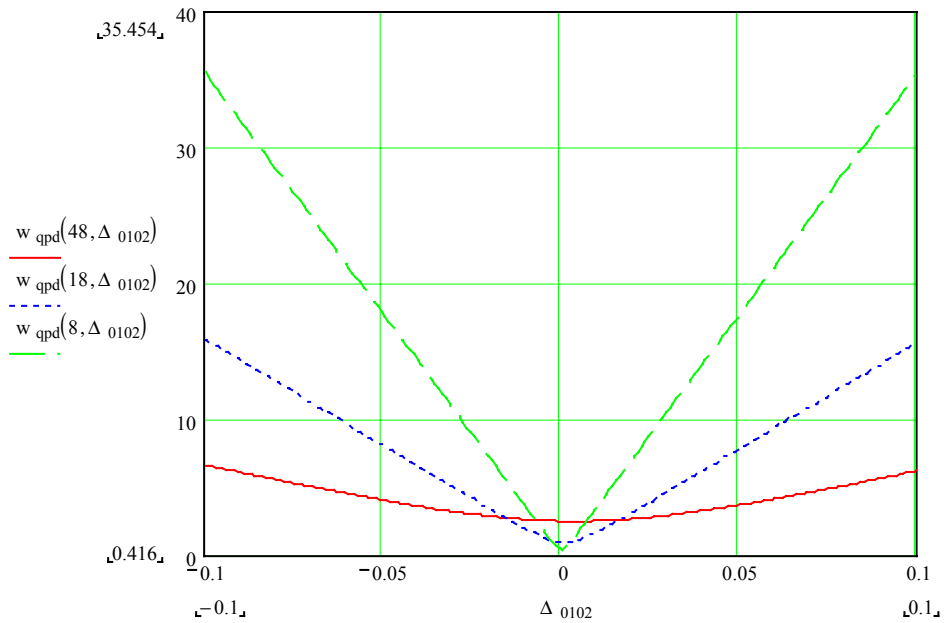

Figure 7: QPD Spot Size Vs Defocus Distance of Front Zoom Lens

3.5 Cross-coupling Between Beam Displacement and Angle Measurement

The cross-coupling error, which is the ratio of the QPD beam height to the input beam displacement with zero angular motion of the beam, is negligible, when the objective lens is properly focussed, as shown in Figure 8: QPD Angular Signal Due to Lateral Displacement of the Optical Lever Beam.

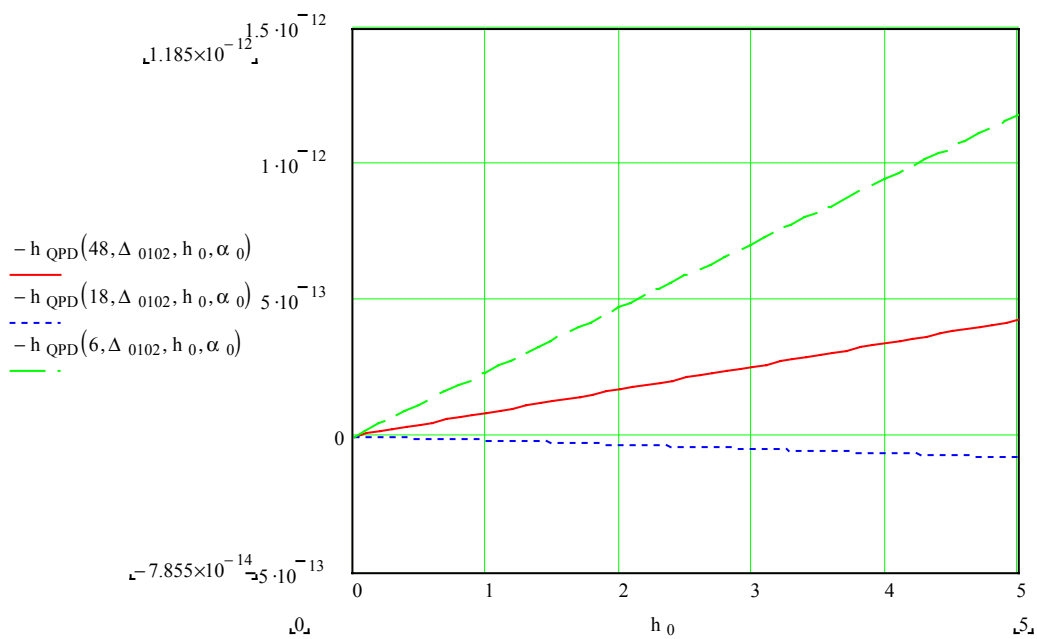

Figure 8: QPD Angular Signal Due to Lateral Displacement of the Optical Lever Beam

The solid trace is the height signal with the zoom lens set at 48mm, the dotted trace is with the zoom lens set at 18mm, and the dashed trace is with the zoom lens set at 8mm. The cross-coupled signal is less than 2×10^{-11} mm for a displacement of 5mm.

However, defocussing the front zoom lens a strong effect on the cross-coupling error, as shown in Figure 9: Cross-coupling Vs Defocus Distance of Front Zoom lens. The cross-coupling error is approximately 10% for a defocus distance of ± 0.006 mm with the zoom lens set at 48mm. The cross-coupling is approximately 60% for the same defocus distance with the zoom lens set at 8mm.

3.6 Focussing Method

The method for focussing the zoom objective lens system is to adjust the focus ring on the zoom lens until a pure displacement of the input beam gives a minimum angle signal at the output of the QPD.

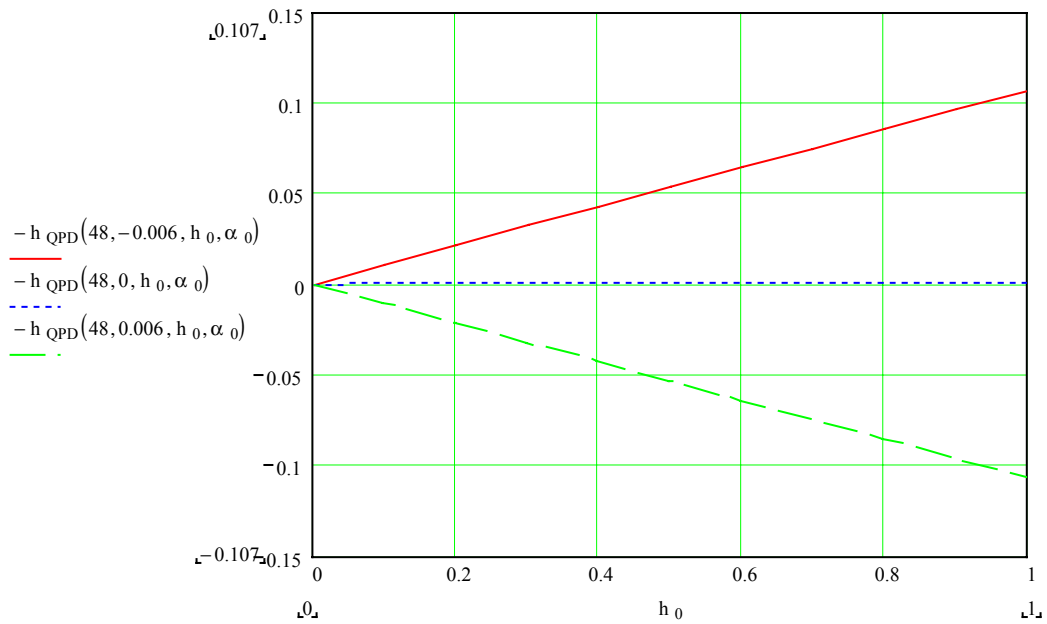

Figure 9: Cross-coupling Vs Defocus Distance of Front Zoom lens