



LIGO Laboratory / LIGO Scientific Collaboration

LIGO- T030137-06

ADVANCED LIGO

NOV 21, 2004

ETM Controls Prototype: - Mass estimate of an ETM suspension layout.

Calum I. Torrie, Michael Perreur-Lloyd * Norna A. Robertson *[^],
Dennis Coyne, Larry Jones, Janeen H. Romie, Caroline Cantley * and Russell Jones *

Distribution of this document:
LIGO Science Collaboration

This is an internal working note
of the LIGO Project.

California Institute of Technology
LIGO Project – MS 18-34
1200 E. California Blvd.
Pasadena, CA 91125
Phone (626) 395-2129
Fax (626) 304-9834
E-mail: info@ligo.caltech.edu

Massachusetts Institute of Technology
LIGO Project – NW17-161
175 Albany St
Cambridge, MA 02139
Phone (617) 253-4824
Fax (617) 253-7014
E-mail: info@ligo.mit.edu

LIGO Hanford Observatory
P.O. Box 1970
Mail Stop S9-02
Richland WA 99352
Phone 509-372-8106
Fax 509-372-8137

LIGO Livingston Observatory
P.O. Box 940
Livingston, LA 70754
Phone 225-686-3100
Fax 225-686-7189

<http://www.ligo.caltech.edu/>

* Institute for Gravitational Research, Dept. of Physics and Astronomy, University of Glasgow, Glasgow, G12 8QQ, U.K.

[^] Department of Applied Physics, Ginzton Laboratory, Stanford University, Stanford, CA, 94305

Rev 06: Contingency removed from suspended masses
Rev 05: Includes updates as per T040028-00 by NAR ref new Appendix D!
Rev 04 – Includes a schematic of the support structure
Rev 03 – Includes comments from the July 5th Review.
Rev 02 – Includes the addition of Appendix D, a breakdown of the lengths associated with an ETM.
Rev 01 – For Review by NAR, LJ, MPL and JHR

1.1 INTRODUCTION

A recent request from the seismic group has been for the suspension team to look at the mass budgets associated with the suspensions. Dennis Coyne brought together an estimate of the configurations of all of the suspensions in Advanced LIGO.

The suspension team has taken a closer look at the largest of the suspensions, namely the ETM (End Test Mass), to confirm that this estimate is realistic. The heaviest chain has two quadruple pendulum suspensions with masses 22,22,40,40 kg from top to bottom. The following sections outline the history, a summary of the initial estimate and the numbers that were re-visited using a combination of a SolidWorks layout, the MATLAB suspension model and an analysis from ALGOR. In re-visiting the numbers in more detail the suspension team considered: the key support points for the non-suspended items, i.e. stop positions, coil positions, or more generally tablecloth assembly positions, eddy current damper positions, etc; a structure that ties these points together; the layout and arrangement of the modeled suspended items. ¹

1.2 SUMMARY OF INITIAL ESTIMATE

The initial analysis carried out in order to calculate a mass budget for the ETM was split into three sections: -

- Quadruple Pendulum Suspension, from MATLAB model.
- Non-Suspended Components
- Structure

All of these components were then brought together and a contingency added. These are outlined below: -

1.2.1 MATLAB Suspension Model

Norna Robertson has modeled a quadruple pendulum suspension with masses 22,22,40,40 kg from top to bottom. A summary of how this arrangement came about can be found in Appendix A.

The ETM has a main and a reaction chain: -

Main Mass Suspension: - 22-22-40-40 = 124 kg
 Reaction Mass Suspension: - 22-22-40-40 = 124 kg

1.2.2 Non-Suspended Components

A detailed description of how an initial estimate of 70 kg was derived for the non-suspended components can be found in an appendix B.

1.2.3 Structure

As outlined above the structure should be designed to tie the suspension points together efficiently, an estimate was made of ~ 60 kg.

1.2.4 Initial Estimate of Masses

Dennis Coyne grouped the following information: -

Chain 1:- 22-22-40-40	= 124 kg
Chain 2:- 22-22-40-40	= 124 kg
Non-Suspended Components (see above)	= 70 kg
Structure	= 60 kg
Total	= 378 kg
TOTAL (including 25% contingency)	= <u>472 kg</u>

1.3 MASSES FROM SOLIDWORKS AND FEA ANALYSIS

Mike Perreur-Lloyd, Dennis Coyne, Janeen Romie, Norna Robertson and Calum Torrie have now confirmed the estimates by developing assemblies created in SolidWorks, analysed in ALGOR and then compared with the MATLAB suspension model. The three sections estimated above are now revisited below.

1.3.1 Suspended Masses

- **Top and Upper Intermediate Masses**

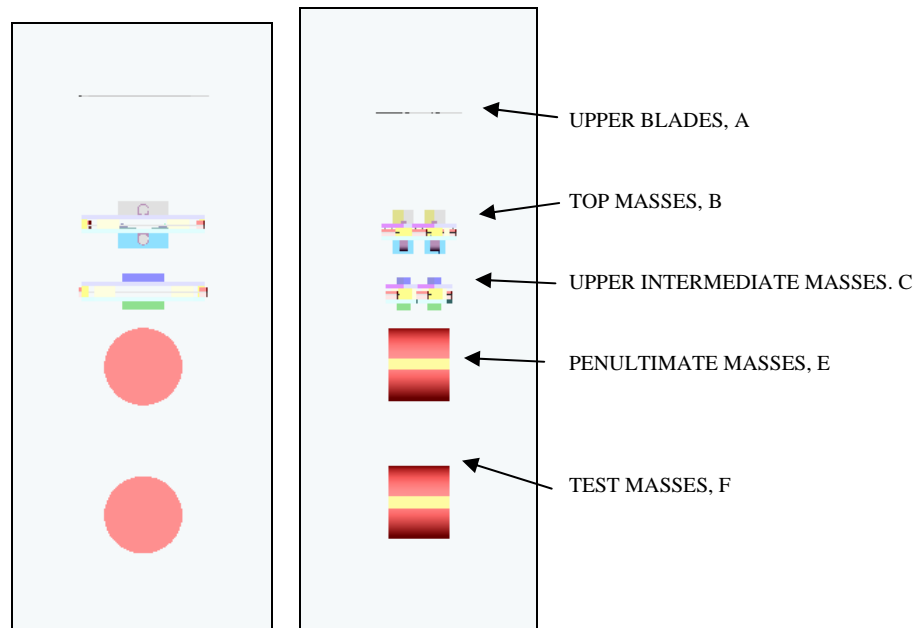

Figure (1): - Schematic of the layout of the suspended masses.

The right hand sketch shows the main and reaction mass suspensions, with a separation of 5mm.

The top and upper intermediate mass were designed in SolidWorks using the parameters from the MATLAB suspension model.

Top Mass	= 21.8 kg (~22kg)
Upper Intermediate mass	= 21.8 kg (~22kg)
Top Reaction Mass	= 21.8 kg (~22kg)
Upper Intermediate Reaction Mass	= TBD * (~22kg)

* As includes 4 coils used for global control. Incorporating coils into large suspended masses has been done before in GEO 600, see picture 1 in appendix 3.

Several aspects and possibilities for the top, upper intermediate and top reaction masses have been considered and are outlined in the summary below.

- **Summary of Top & Upper-Intermediate Masses**

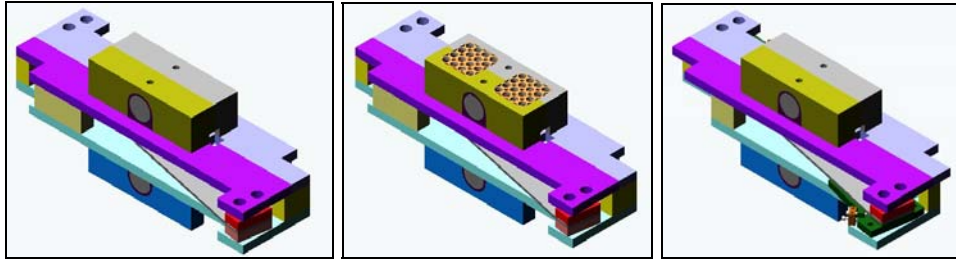

Figure (II): - Schematics of three different top mass configurations.

The ETM Top Mass: To address the perceived risk of a 22 kg top mass incorporated into a quadruple pendulum suspension with masses 22,22,40,40 kg from top to bottom, several configurations have been considered.

It has been confirmed, through calculation and simple tests, that a top mass can be designed to be strong enough to suspend 102kg. Two 4x4 arrays of copper blocks, that are part of an Eddy Current Damper assembly, have been integrated into the Top Mass T-Section. Within the configurations several methods of adjustability have been developed. These are based on adjustments that have been included in previous suspension designs. They include: -

- Rotational Adjusters for the Blades for YAW adjustment
- Adjustment of the upper wire clamps for PITCH adjustment
- Offset masses in T-pieces for PITCH & ROLL

Whether we require all of these or other adjustments has yet to be decided. The mass and moments of inertia of each of these configurations have been checked so that they are within the limits set by the MATLAB Suspension model.

The ETM Upper Intermediate Mass: A layout based upon an early iteration of the Upper Mass layout design has been drawn up for the ETM Upper-Intermediate Mass. As the upper-intermediate mass has smaller blades and suspends a lesser weight than the Upper Mass, it has not been necessary to develop this design quite as far. We can assume that since we can design a 22kg mass that can carry 102kg with large blades and incorporate the levels of adjustment stated above, the design of a 22kg mass that suspends only 80kg will be relatively straightforward.

- **Penultimate and Test Masses**

For the Noise Prototypes the lower intermediate and test masses will be either silica, sapphire or heavy glass. In order to consider how this would be done for the Controls Prototype work has been done to consider possible designs for these, as outlined below.

Test Mass	= 40 kg	
Reaction Mass	= 40 kg	(With electrostatic drive)
Penultimate Mass	= 40 kg	
Penultimate Reaction Mass	= 40 kg	(GEO design that includes coils)

- **Overall Total for Suspended Components**

Main Suspension	= 124 kg
Reaction Chain Suspension	= 124 kg

OVERALL TOTAL FOR SUSPENDED COMPONENTS = 248 kg

All of the masses for the Controls Prototype will be made from a combination of stainless steel and aluminum with the required cutouts in to order to obtain correct mass and moments of inertia. They would also have removable front and back sections.

1.3.2 Non-Suspended Components

All of the estimates for the non-suspended components are for a quadruple pendulum with a main and reaction mass suspension. The mass estimates are split into the four positions shown in *figure (I)*.

- **Clamps, Adjusters and Stops at Top Blades, see *figure (I)***

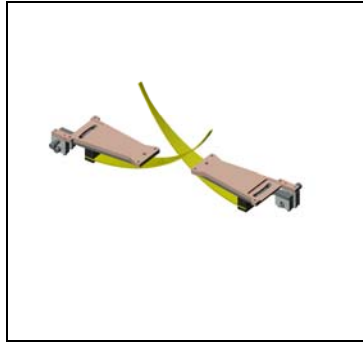

Figure (III): - Schematic of possible top blade yaw adjuster.

This section should include the rotational adjusters, blade guard and stops as well as the clamps to fix the suspension to the seismic table. Two rotational adjusters are required per suspension.

Dog Clamps	= 4 kg	(for bolting the structure to the seismic table)
Rotational Adjuster	= ~ 18 kg	(4 total)
Blade Guards and stops	= 2 kg	(incorporated into Rotational Adjuster)

[TOTAL MASS of CLAMPS etc... at the POSITION OF THE TOP BLADES = 24 kg](#)

If it is important to be able to individually align the two chains, in an ETM, in yaw so as to allow for alignment of the two faces of the test masses then some form of rotational adjuster must be included

It should be noted that the authors have considered a possible weight saving solution. The idea would be to attach the top cantilever blades to the underside of the structure. This would allow for a flat top surface for clamping to the seismic table and would also allow for blade guards and stops to be incorporated into the suspension structure.

- **Tablecloth, Coils and Eddy Current Dampers at Top Mass, see figure (I)**
 - **Tablecloth**

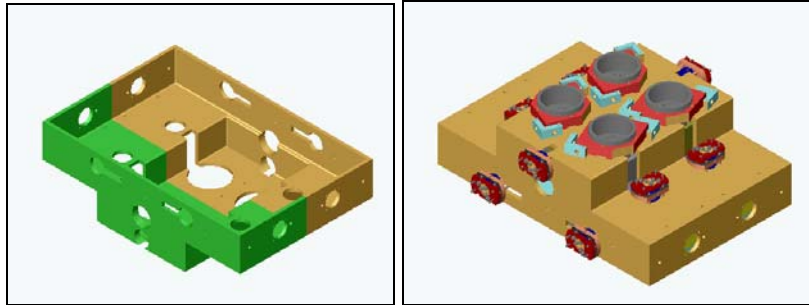

Figure (V): - Schematic of possible tablecloth for the top mass. The LHS show a bare tablecloth and the RHS shows a tablecloth with 12 local control coils and 4 eddy current damper arrays.

The tablecloth at the top mass is made of two halves of Aluminum each of 4kg, plus 1kg for brackets to interface with the structure. At this point there is still a question of whether an adjustment mechanism is required to align the tablecloth and the coil assemblies with respect to the magnets on the top mass. However it could be conceivable that this adjustment mechanism could be removable.

TABLE CLOTH MASS TOTAL = 9 kg + TBD? (adjustment wrt suspension)

- **Coil Head Assembly and Associated Parts**

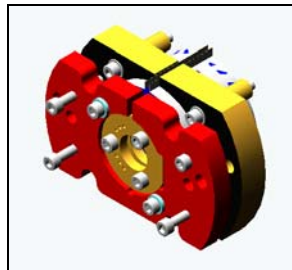

Figure (IV): - Schematic of the Coil Assembly, D020225.

The mass of the coil head and associated parts, D020225-09, is 130g. There are six such local control coils per suspension and two identical suspensions.

COIL MASS TOTAL = ~ 1.5 kg

In the above assumption the coil head and associated parts are made from Aluminum. A further reduction in mass could be gained if PEEK is chosen as the material for the coil head. However, this would not be as substantial as the gain already achieved by moving from stainless steel.

- **Eddy Current Dampers**

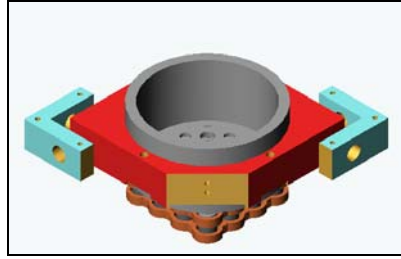

Figure (VII): - Schematic of a possible eddy current damper assembly.

The Eddy Current Dampers considered below were not included in Larry's estimate. The current thinking is that two 4 by 4 arrays on the top mass of each suspension will provide the required level of damping. The copper arrays will be included in the mass of the top mass, see *figure (II)*.

Overall Eddy Current Damper Assembly	= 800 g
Eddy Current Damper minus the copper	= 600 g
EDDY CURRENT DAMPERS MASS TOTAL	= ~ 2.5 kg

A lightweight "Olympic Rings" Copper array has been designed and the plan is to compare the damping produced by it to that of the original solid copper array.

TOTAL MASS at the POSITION of the TOP MASS = 13 kg + TBD?

- **Tablecloth and Earthquake Stops at the Upper Intermediate Mass, see *figure (I)***

It is assumed that the Upper Intermediate Mass and upper IM reaction mass will have some form of tablecloth similar to the one shown in *figure (V)*, in order to allow for earthquake stops. There are no eddy current dampers or coils acting between the structure and the suspension at this stage.

TOTAL MASS at the POSITION of the UPPER INT. MASS = 9 kg

- **Earthquake Stops and Support Structure at the Penultimate mass and test masses**

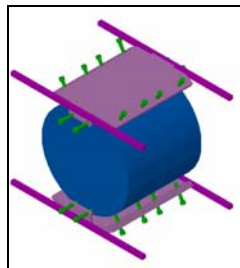

Figure (VI): - Schematic of possible earthquake stop configuration for optic and reaction mass.

We have assumed that some form of GEO catcher / fixture, like the one shown on picture 2 in appendix C, will be used to position the optics in the tank. It will then be stripped of any mechanical components resulting in something similar for each stage to that shown in *figure (VI)* above.

The configuration in *figure (VI)*, above, is for an assembly process where the reaction chain is assembled and installed at the same time as the main chain. If they are done separately, the earthquake stop brackets could be made of 2 pieces as opposed to one and four more support struts would have to be added. The support struts are 0.5" x 0.5" x .058" thick wall x 18.7" long. It is assumed that there will be some form of earthquake stop between the optic and its reaction mass to maintain the approx 5mm separation. However, due to the small spacing between the optics it is believed that such a device would have negligible mass. It could be a Viton tip mounted in a 4–40 screw. Further add four more support struts for each section (test mass & test mass reaction mass) - $4(.09\text{kg}) = .36\text{ kg}$. The .09kg per bar is for bars with .25" thick end caps.

Firstly we will consider the supports associated with the test mass optic and the reaction mass optic with the assumption that the suspensions are assembled separately: -

Stops	= 24 x (.042 kg)	= 1.0 kg
Stop Bracket	= 2 x (2.38 kg)	= 4.76 kg
Support Strut	= 8 x (.08 kg)	= 0.64 kg
Additional Support Strut (.09kg)		= .36 kg
Total (optic plus reaction mass)		= ~ 7.0 kg

Using this answer and the one derived in the previous section we can consider the earthquake stops at all of the stages: -

TOTAL MASS at the Penultimate Mass and Penultimate reaction mass: = 7.0 kg

TOTAL MASS at the Test Mass & reaction mass: = 7.0 kg

- **Overall Total for Non-Suspended Components**

OVERALL TOTAL FOR NON-SUSPENDED COMPONENTS ~ 60 kg +TBD?

Summary: - Mass of the non-suspended components at the various positions of a suspension: -

Upper Blades, <i>A</i>	= 24 kg
Top mass and reaction mass, <i>B</i>	= 13 kg +TBD
Upper int mass and upper int reaction mass, <i>C</i>	= 9 kg
Penultimate mass and Penultimate reaction mass, <i>E</i>	= 7 kg
Test mass and reaction test mass, <i>F</i>	= 7 kg

I WOULD RECOMMEND THE TOTAL FOR NON-SUSPENDED COMPONENTS = 70kg

1.3.3 Structure and Spacer

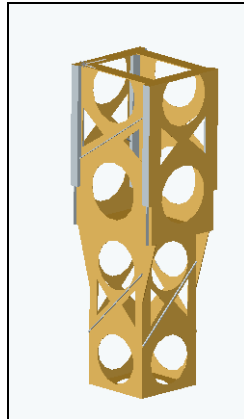

Figure (VIII): - Schematic of a Quadruple Pendulum Structure from T030044.

Analysis of several concepts for a quadruple pendulum suspension structure has been done by Dennis Coyne and is written up in T030044. In it several designs are considered one of which has a bare structure of 45 kg. It is noted in the report that the length of this structure has to be increased from ~200 cm to ~210 cm.

Structure	= 45 kg
Extra Support to mount top blades, see <i>figure IX</i> below	+ 13 kg
Increased Length of 10cm	+ 8 kg

It should be noted that this estimate has allowed for the idea of mounting the topmost cantilever blades on the underside of the top of the structure, highlighted in section 1.3.2, and extra support to allow the blades to be mounted to the structure securely.

TOTAL STRUCTURE MASS TOTAL = 66 kg

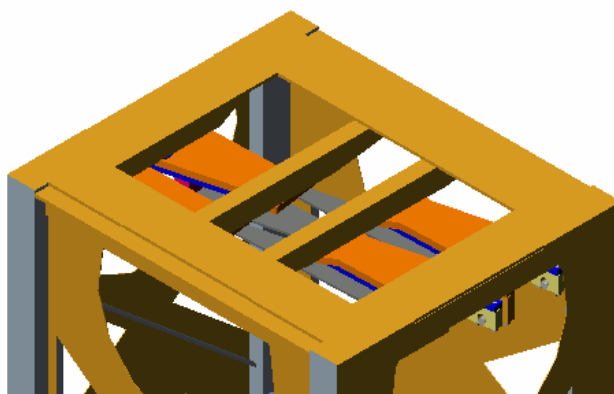

Figure (IX): - Schematic of the extra support required for mounting the top cantilever blades.

1.3.4 Updated Overall Estimate of Masses: -

ESTIMATE	UPDATED	(INITIAL)
Suspended Components: - 2x (22, 22, 40, 40 kg)	= 248 kg	(as before)
Non-Suspended Components	= 70 kg	(70 kg)
Structure	= 66 kg	(60 kg)
Total	= 384 kg	
TOTAL (incl, 25% contingency)	= 480 kg	(472 kg)

CONTINGENCY REMOVED FROM SUSPENDED MASSES IMPLIES TOTAL = 418 kg ¹

1.3.5 Centre of Gravity, CG, Calculation for the Non-Suspended Components and the Suspension Structure.

The center of gravity for the structure and the non-suspended components is outlined below: -

Position on non-suspended components, see figure in appendix D1: -

Upper Blades, <i>A</i>	= 24 kg
Top mass and reaction mass, <i>B</i>	= 13 kg + TBD
Upper int mass and upper int reaction mass, <i>C</i>	= 9 kg
Penultimate mass and Penultimate reaction mass, <i>E</i>	= 7 kg
Test mass and reaction test mass, <i>F</i>	= 7 kg

Structure: -

The Structure mass, <i>S</i>	= 66 kg
------------------------------	---------

Non-suspended components and structure: -

Total Non Suspended Mass, <i>M</i>	= 126 kg +TBD
------------------------------------	---------------

Therefore, $CG = [(A \times D1) + (B \times D2) + (C \times D3) + (E \times D4) + (F \times D5) + (S \times D6)] / (M)$

Where the D's are the distance from seismic table to the relevant stages.

Implies, $CG = [(24 \times 8) + (13 \times 62) + (9 \times 90) + (7 \times 124) + (7 \times 184) + (60 \times 49.4^*)] / (126)$

CG = 55 cm below the interface between the seismic table and the suspension structure.

* 49.4 cm is for a 66kg structure that incorporates the required length of a structure of 210cm and a plate to suspend the suspension from.

¹ REFERENCE COMMUNICATION WITH DENNIS COYNE AT LIGO SYSTEMS MEETING

1.3.6 Conclusions

The updated mass total is ~ 10 kg lighter than the initial estimate; most of the savings comes from the non-suspended components. In Appendix C Larry Jones makes the point that in order to be careful perhaps we should stay with 70 kg. With the as yet unanswered question regarding tablecloth adjusters, the estimate of the rotational adjuster at the top blades and the validity of removing the mechanisms around the sapphire or silica catcher perhaps we should stay with at least 70 kg, although this is up for debate. In Appendix D the lengths are broken down in all of the degrees of freedom.

~~1.3.7 To Be Determined~~

~~I believe Revision 03 of this document might allow us to consider reducing the 25% contingency? It also leaves 2 questions unanswered. Whether or not TABLECLOTH ADJUSTERS are required and how much of a risk is it not to consider the layout of an UPPER INTERMEDIATE REACTION MASS.~~

APPENDIX A: **Quadruple Pendulum Suspension for Advanced LIGO** **History by Norna A. Robertson**

Norna provided a brief history of the quad design. The original theory was to keep the masses the same. They tried not to deviate from this by more than a factor of 2. So, the MIT quad is 15kg, 15kg, 16kg and 30kg (top to bottom). The 16 and 30 kg were chosen to mimic a sapphire test mass and a fused silica penultimate mass of the same size. The design was then changed to take a 40kg test mass and to meet the 10 Hz requirement by using a heavier penultimate mass made of ultra-dense glass. This design, which is in the conceptual design document written in Sept 2001, has masses 36,36, 72, 40. Peter Fritschel then submitted the 10 Hz cutoff paper. So Norna looked at several different models in her paper that don't satisfy the 10 Hz requirement and that have a lighter penultimate mass. One of these was a scaled up version of the MIT quad, namely 22,22,22,40, with sapphire test mass and silica penultimate mass. This was the lightest option, and so attention was focused on it for keeping overall mass as low as practicable when loading of the seismic table became an issue. However if silica is used for the test mass, the logical penultimate material would be silica and thus the chain becomes 22, 22, 40, 40. Such a chain is possible for sapphire as well and so this set of masses is under investigation with the aim of having a design, which could work for sapphire or fused silica as the test mass material, with only a change in shape as opposed to mass. SF4 heavy glass, which is easily obtained, is a potential material for the penultimate mass for a sapphire test mass. It is actually more dense than sapphire at 4.8 g/cc. So, for the same shape as sapphire, it would be 48 kg. The top and bottom could be cut off to make the mass 40kg. Alternatively the penultimate mass could be sapphire.

APPENDIX B: Detail of the initial estimate of the mass and CG for the Non-Suspended Components.

Email by Larry Jones on 28th March 2003

How the initial estimate of the mass and CG of the non-suspended was derived is best understood with a reference to an e-mail from Larry Jones' on 28th March 2003: -

"Dennis, ... You asked for Calum and me to better estimate the CG of the ... 25 kg of "other" mass involved with the quads (besides structure and mass elements).

We weighed elements from the small triple suspension and I scaled from there:

Clamps: the large stainless steel clamps used currently weigh 0.32 kg ea, with screw. I'm estimating that we use 10 clamps per LOS currently. Changing to aluminum and scaling to 30 clamps for the quad perimeter and adding a few for central hole clamping gives approx. 4 kg.

Coil Assembly and Associated Parts: 12 current S/S assemblies weigh 5kg; we can change these to aluminum and come up with approx. 1 kg for each set of 6. I decided to ignore the eddy current dampers, as there's no design and no certainty of need.

Tablecloths and mounting blocks: I estimate the ... total mass of 12 such stainless steel assemblies ... at 2.8 kg. We can change this to aluminum (x .35) and scale it up to the quad size (approx. x 8), giving 8 kg per position.

Earthquake Stops: the aluminum parts for the small triple was weighed out at 1 kg per position; scaling this by x 8 for the quad gives 8 kg per position.

Changed total to 70 kg (this sure seems high):

Thus, the total is closer to $4+1+1+8+8+8+8+8+8+8+8 = 70$ kg, instead of the 25 kg estimate we gave you earlier (given for the MC, we thought we'd scale to the quad size with the same total by changing from S/S to aluminum).

The CG of this conglomerate would be (using spacing from Norna of a shorter quad, plus distributing the added length nearly equally):

Recalculated CG:

$CG = (4*1.5 + 18*60 + 16*89.5 + 16*121.4 + 16*185.0)/70 = 106$ cm below the table surface.

I suppose that it would be possible to reduce the masses below the 70 kg total with some design time, but I'm not sure that we wouldn't have to add some stiffening features to the basic frame to support the EQ stop bars. I would stay with the 70 to be careful. Larry"

Summary of estimates of extra from Larry Jones: -

CLAMPS:	2 kg + 2 kg	= 4 kg
COILS:	1 kg + 1 kg	= 2 kg
TABLE CLOTH:	8 kg + 8 kg	= 16 kg
EQ stops:	8 kg + 8 kg + 8 kg + 8 kg + 8 kg + 8 kg	= 48 kg
TOTAL:		= 70 kg

APPENDIX C: Pictures from GEO 600
from Stefan Goßler, University of Hannover, June 2003

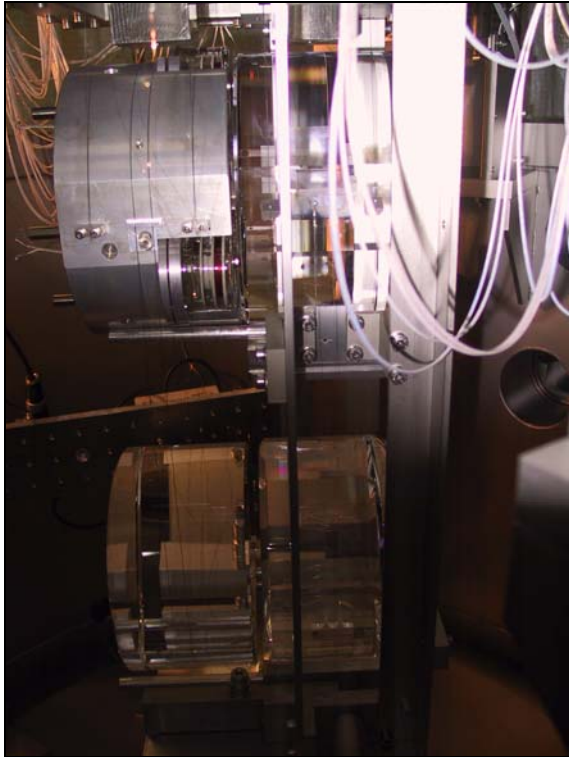

Picture (1 and 2): Picture 1 on the LHS shows one of the main suspensions in GEO 600. Suspended coils can be seen in the aluminum mass in the top left hand side of the picture. Picture 2 on the RHS shows two fused-silica masses in a GEO 600 style catcher / fixture prior to installation into one of tanks.

¹ Information in section 1.1 was summarized from an email from Dennis Coyne to the suspension team on 15th April 2003.

APPENDIX D LAYOUT DESIGN, WITH NEW NUMBERS as per T040028-00

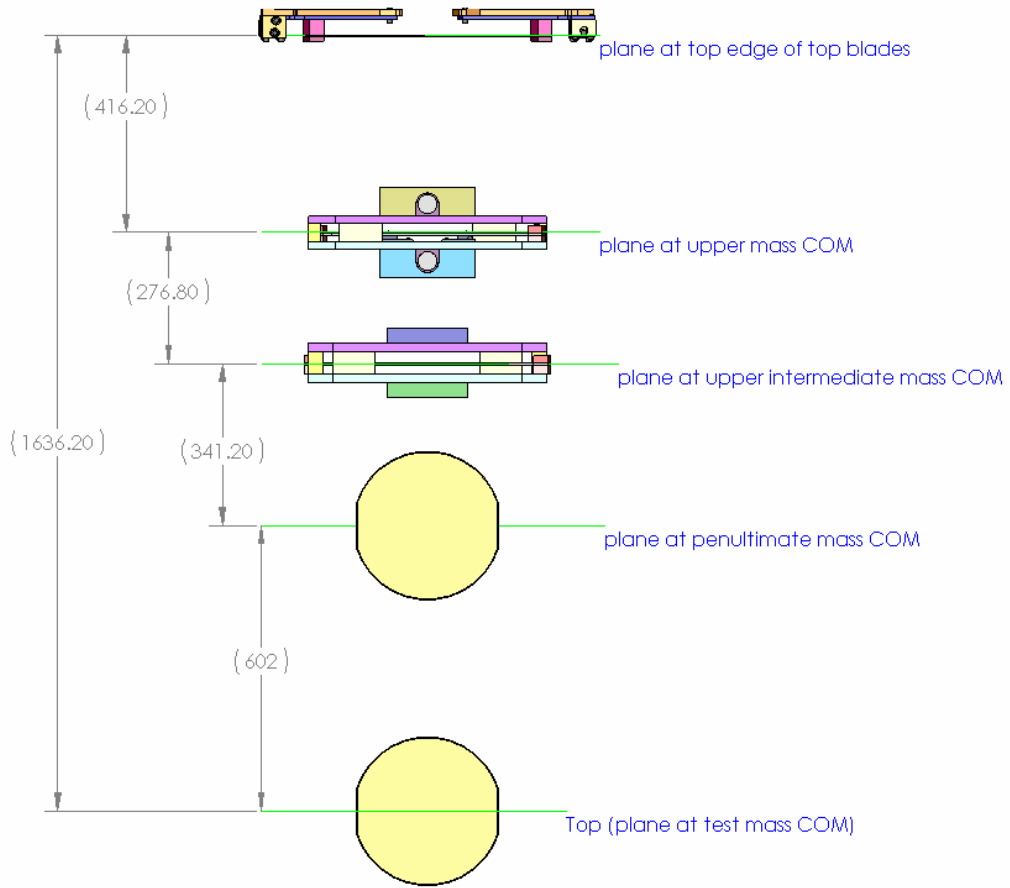

FIGURE (1): - FACE ON VIEW OF QUAD WITH # FROM LIGO-T040028-00

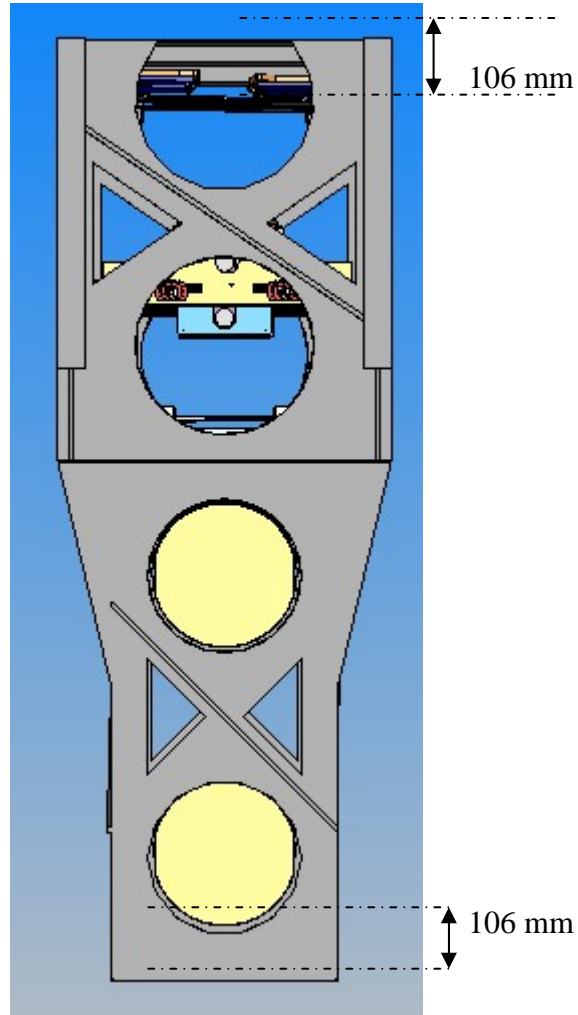

FIGURE (2) : - FACE ON VIEW OF STRUCTURE, AGAIN WITH REFERENCE TO LIGO-T040028-00. EXTRACT FROM G040095-01.

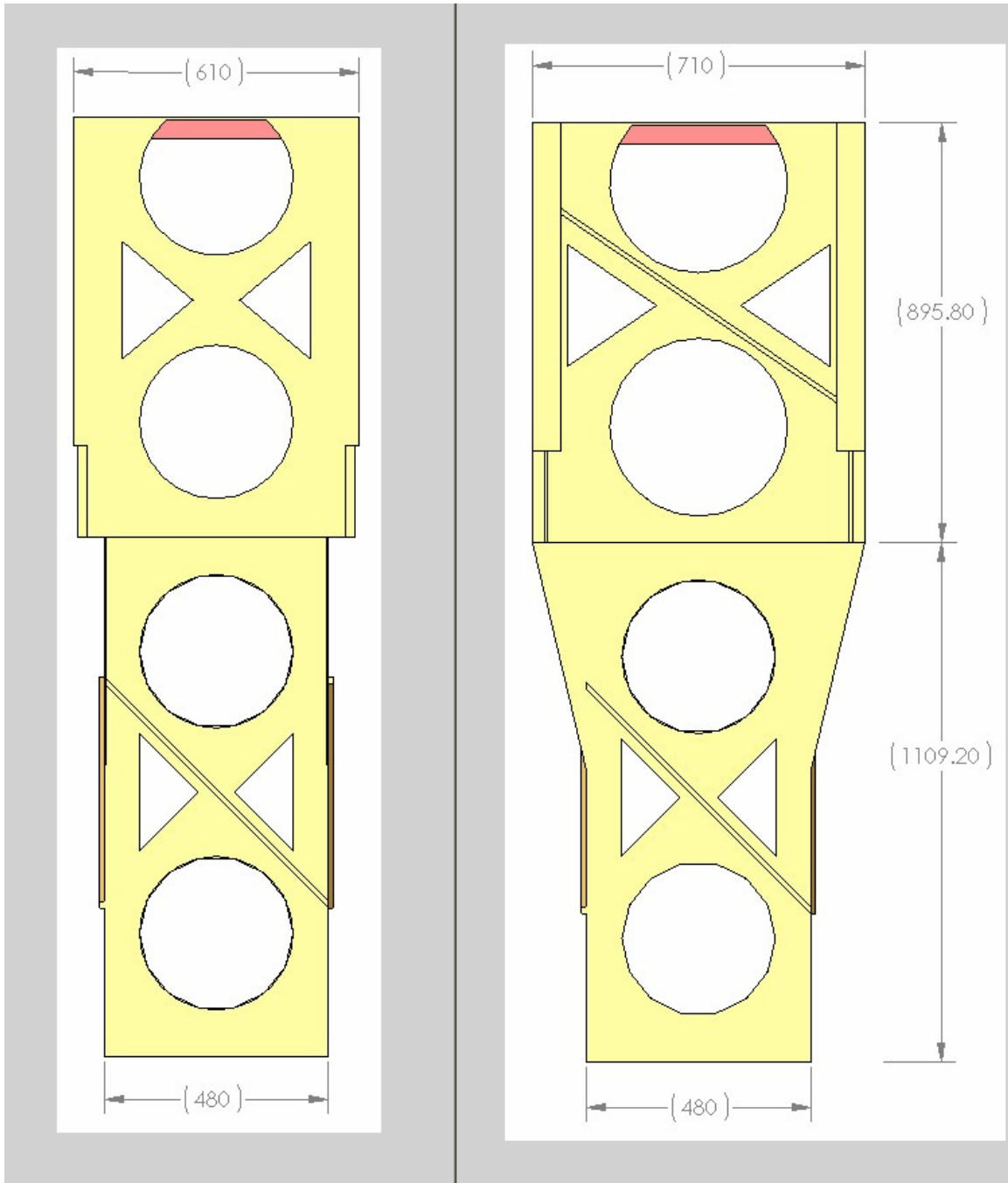

FIGURE (2) : - FACE AND SIDE ON VIEW OF STRUCTURE, AGAIN WITH REFERENCE TO LIGO-T040028-00.
EXTRACT FROM G040095-01.

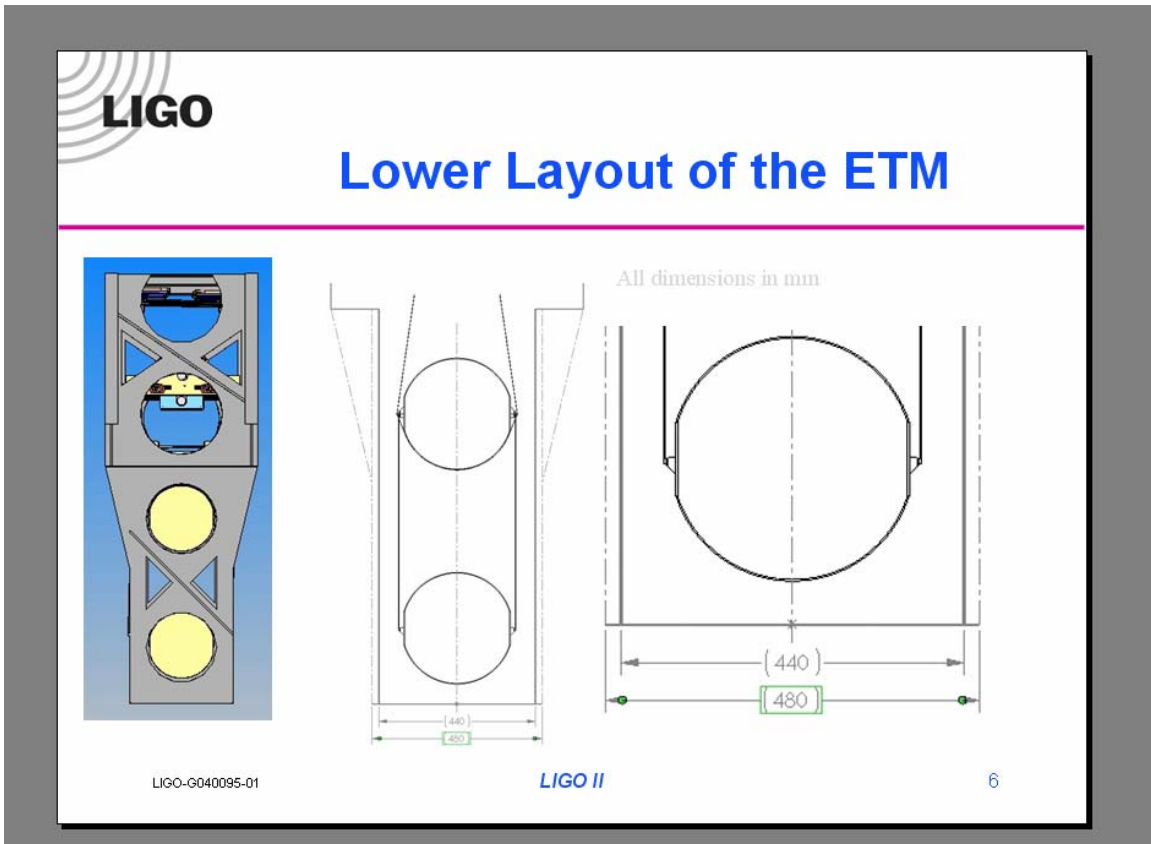

FIGURE (4): - EXTRACT FROM LIGO-G040095-01.
LOWER DIMENSION FACE ON MIGHT HAVE TO BE 440 mm.