

LASER INTERFEROMETER GRAVITATIONAL WAVE OBSERVATORY
- LIGO -
CALIFORNIA INSTITUTE OF TECHNOLOGY
MASSACHUSETTS INSTITUTE OF TECHNOLOGY

Technical Note LIGO-T070034-A - D 2/19/07

Voltage Regulation and Power Supplies

Paul Schwinberg, Daniel Sigg

Distribution of this draft:

all

This is an internal working note
of the LIGO Project.

LIGO Hanford Observatory
P.O. Box 159
Richland, WA 99352
Phone (509) 372-8106
FAX (509) 372-8137
E-mail: info@ligo.caltech.edu

LIGO Livingston Observatory
19100 LIGO Lane
Livingston, LA 70754
Phone (504) 686-3100
FAX (504) 686-7189
E-mail: info@ligo.caltech.edu

California Institute of Technology
LIGO Project - MS 51-33
Pasadena CA 91125
Phone (626) 395-2129
Fax (626) 304-9834
E-mail: info@ligo.caltech.edu

Massachusetts Institute of Technology
LIGO Project - MS NW17-161
Cambridge, MA 01239
Phone (617) 253-4824
Fax (617) 253-7014
E-mail: info@ligo.mit.edu

www: <http://www.ligo.caltech.edu/>

1 SUMMARY

The following 4 approaches were investigated for suitability in building power supplies for advanced LIGO:

1. Noise eater: A circuit to suppress low frequency noise on analog power supplies.
2. Voltage regulator: A very low noise LDO regulator for post-regulation of analog supplies.
3. Point-of-load regulator: A non-isolated power module for digital supplies.
4. Synchronous buck regulator: A power supply to generate local supplies from a 48V DC input.

Fig. 1 shows the concept of the advanced LIGO power distribution system.

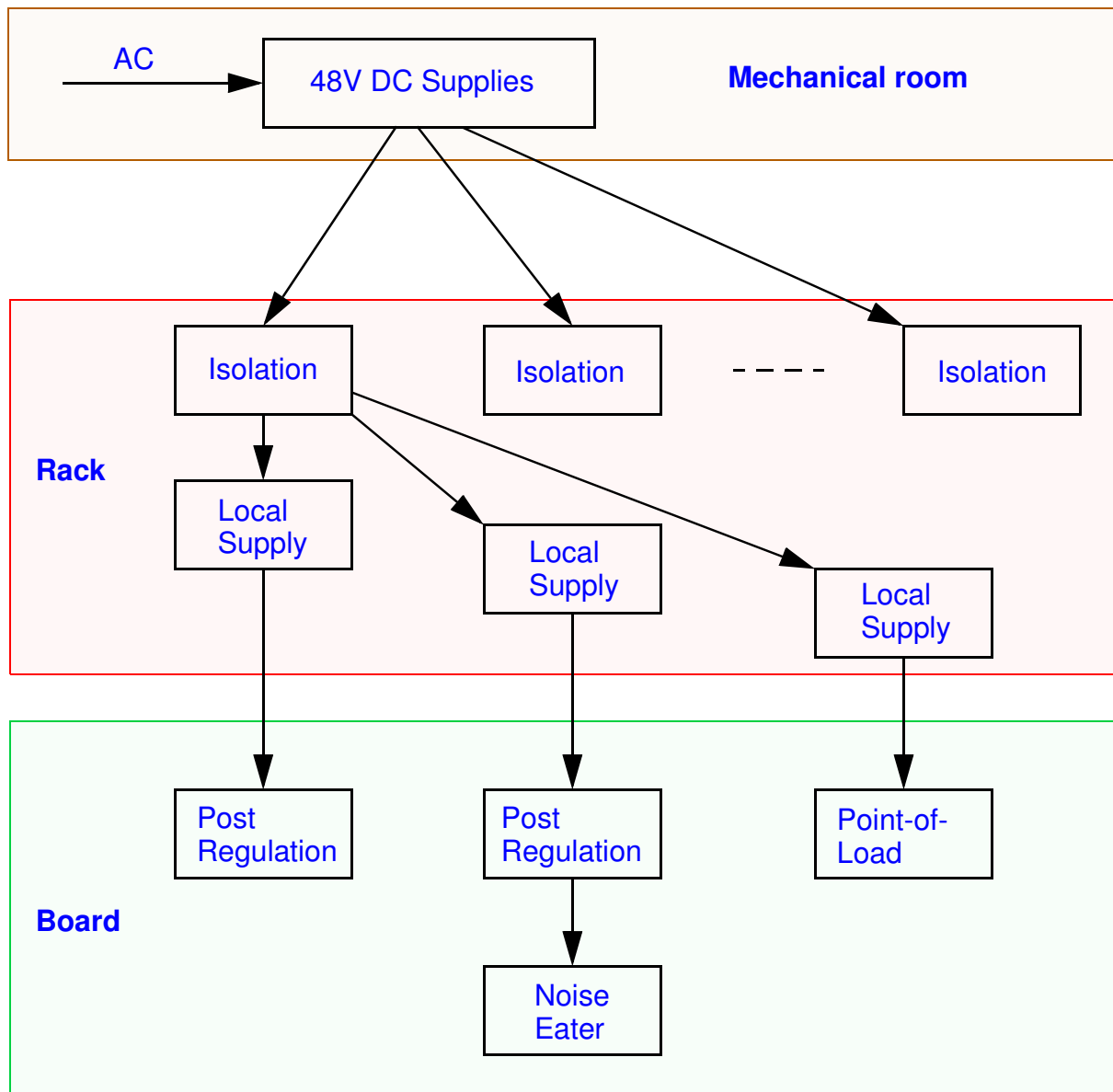

Figure 1: Concept of Power Distribution.

2 NOISE EATER

The noise eater circuit can be used to cleanup an analog power supply. It works by employing a current shunt and a feed forward system which measure the incoming noise level (see Fig. 2). Up to 30dB of suppression can be expected without trimming, but balancing the bias currents is tricky and the required board real estate is excessive. This design is not recommended. If a low noise supply is required a better option is the regulator described in the next section.

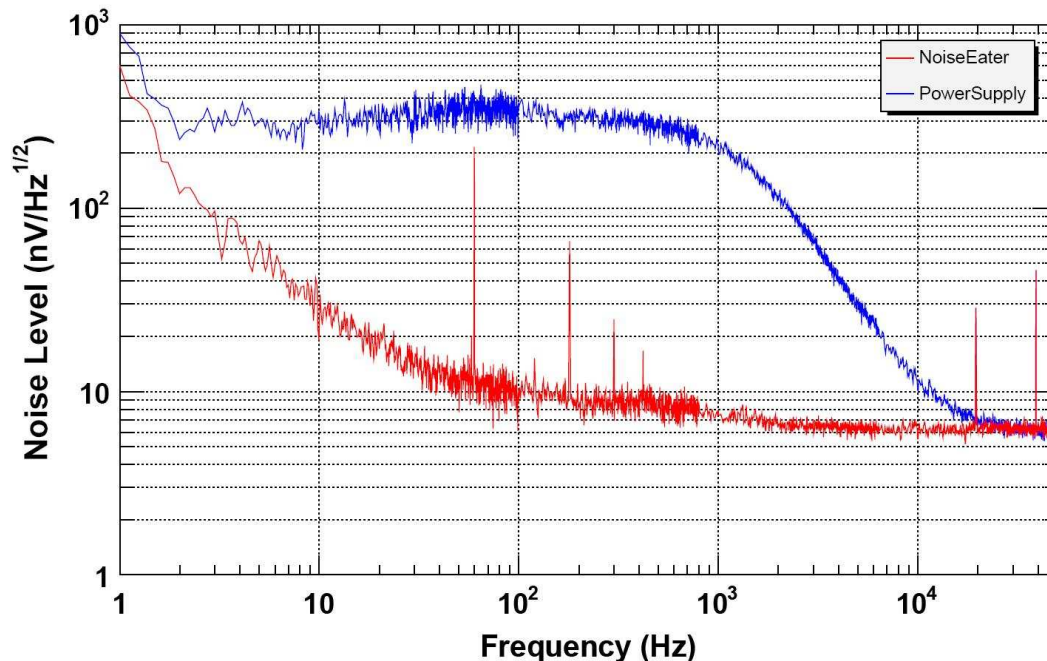
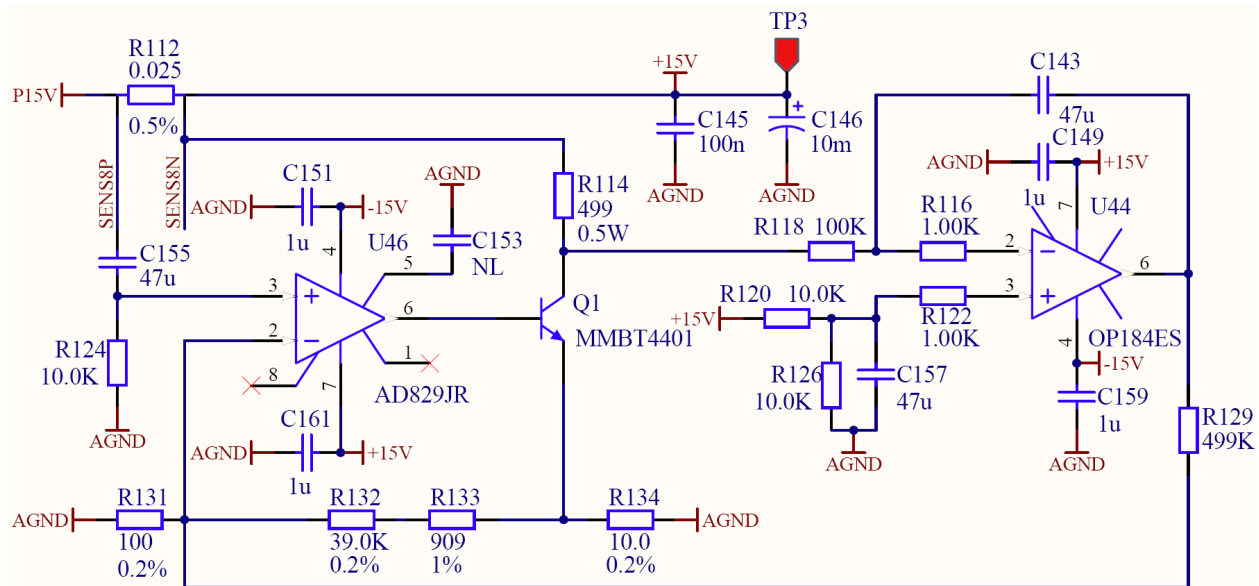

Figure 2: Schematics and performance of noise eater implemented after a standard +15V linear regulator.

3 LINEAR POST REGULATION

A schematics can be found in document LIGO-D060293 (see Fig. 3). Since commercial linear LDO regulators typically use a noisy internal voltage reference and are of limited availability for negative rails, D060293 demonstrates a simple regulator based on a low noise voltage reference. Its disadvantage is the requirement of an additional power rail above the nominal input value to power the feedback circuit. However, its performance is superior to commercial units.

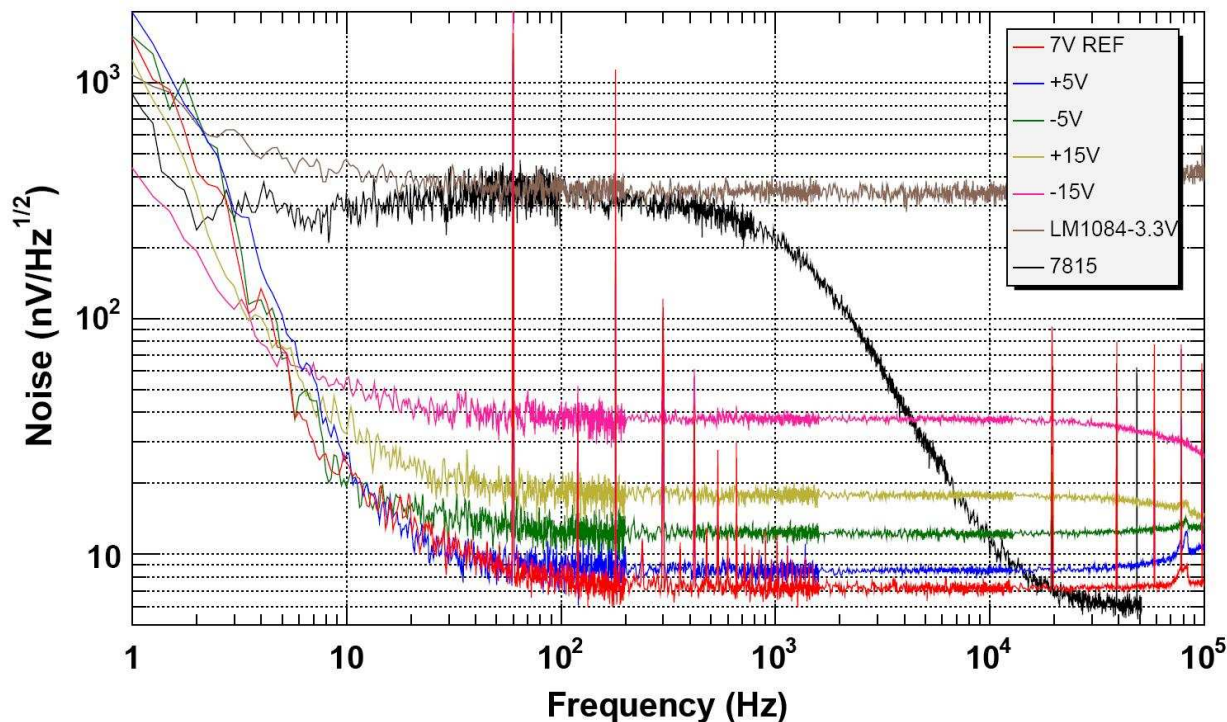
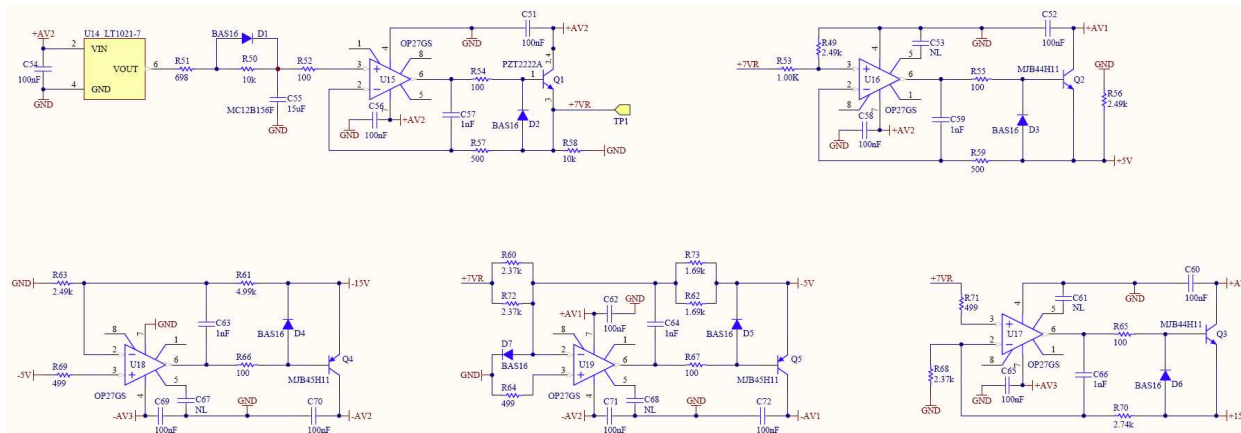

Figure 3: Schematics and performance of a very low noise linear voltage regulator.

The typical supply voltages are $\pm 6.5V$, $\pm 16.5V$ and $\pm 24V$ to generate low noise supplies for analog $\pm 5V$ and $\pm 15V$. At 1 A of current draw the typical voltage drop is about 160mV.

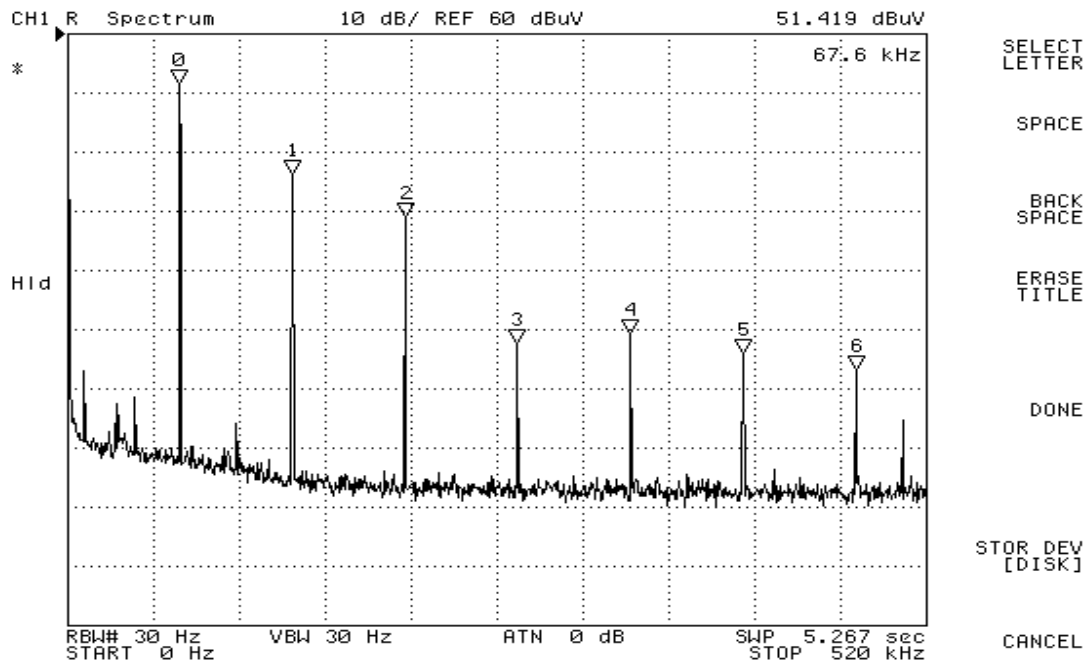
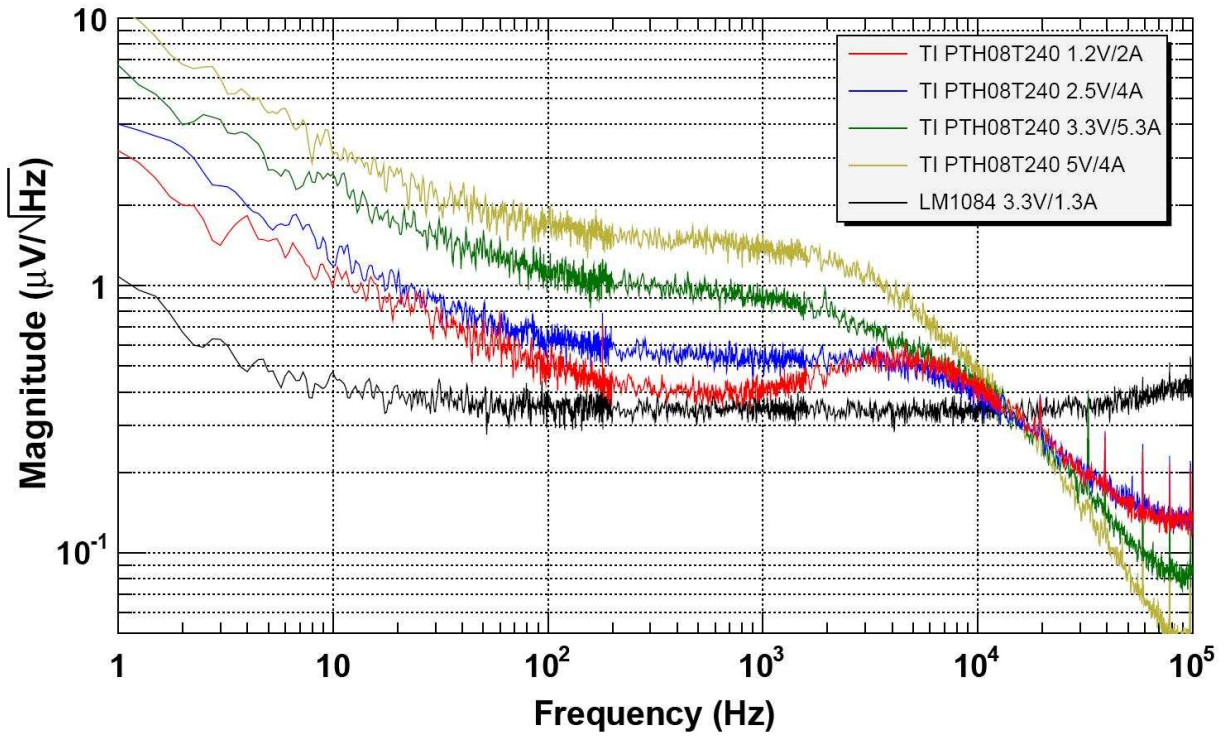

Figure 5: Performance of the point-of-load regulator. Top graph shows the in-band spectrum, whereas the bottom one shows the spectrum of the switching transients.

5 SYNCHRONOUS BUCK REGULATOR

A schematic of the synchronous buck regulator can be found in D060421. The circuit has a wide input range starting a few Volts above the desired output level up to 72V. It is intended to run from a 48V DC power supply. There is PM version which generates both positive and negative rails. It is intended for $\pm 6.5V$, $\pm 16.5V$ and $\pm 24V$. Its maximum output rating is 10A for the positive rail and 8A for the negative rail. The PP version (D060512) implements a positive rail only and is intended for +12V. Its maximum output rating is 20A.

A picture of the PM version (rev B) is shown in Fig. 6.

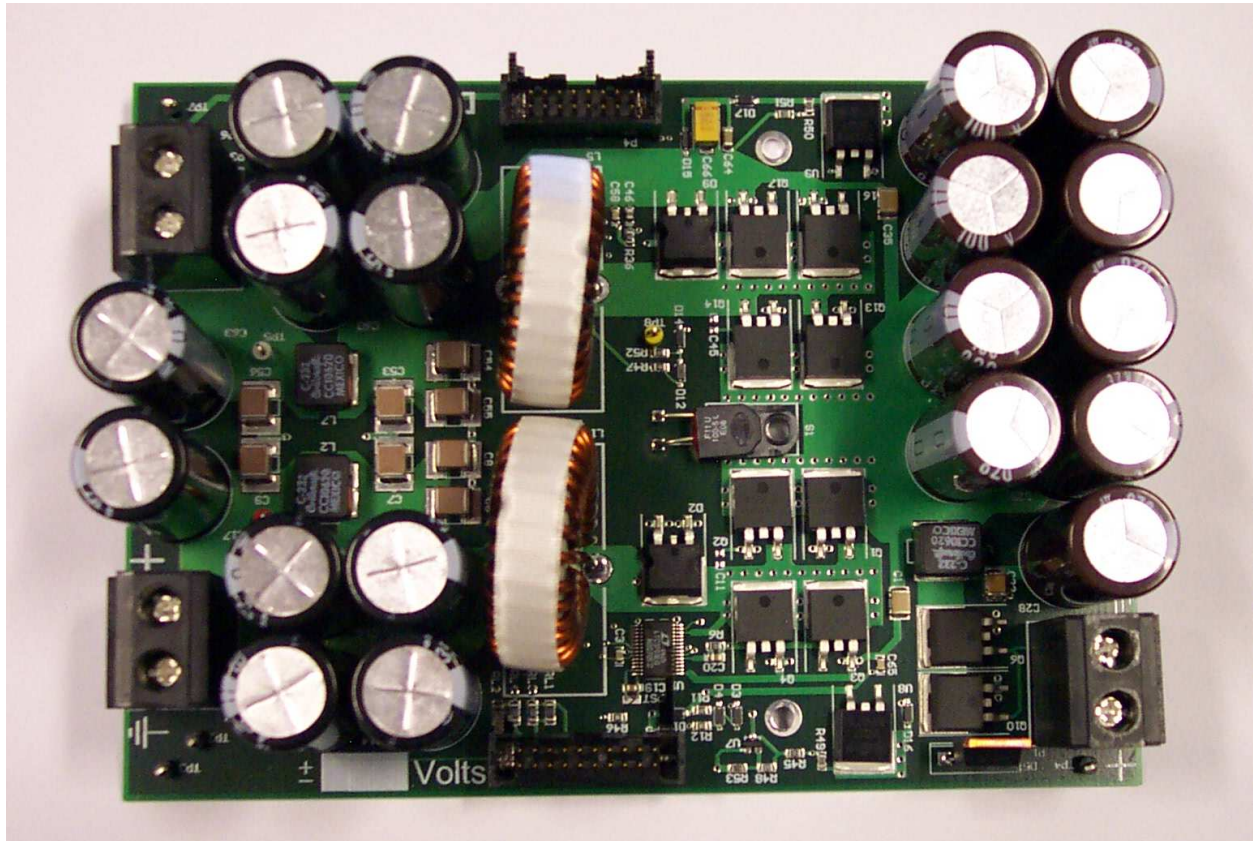
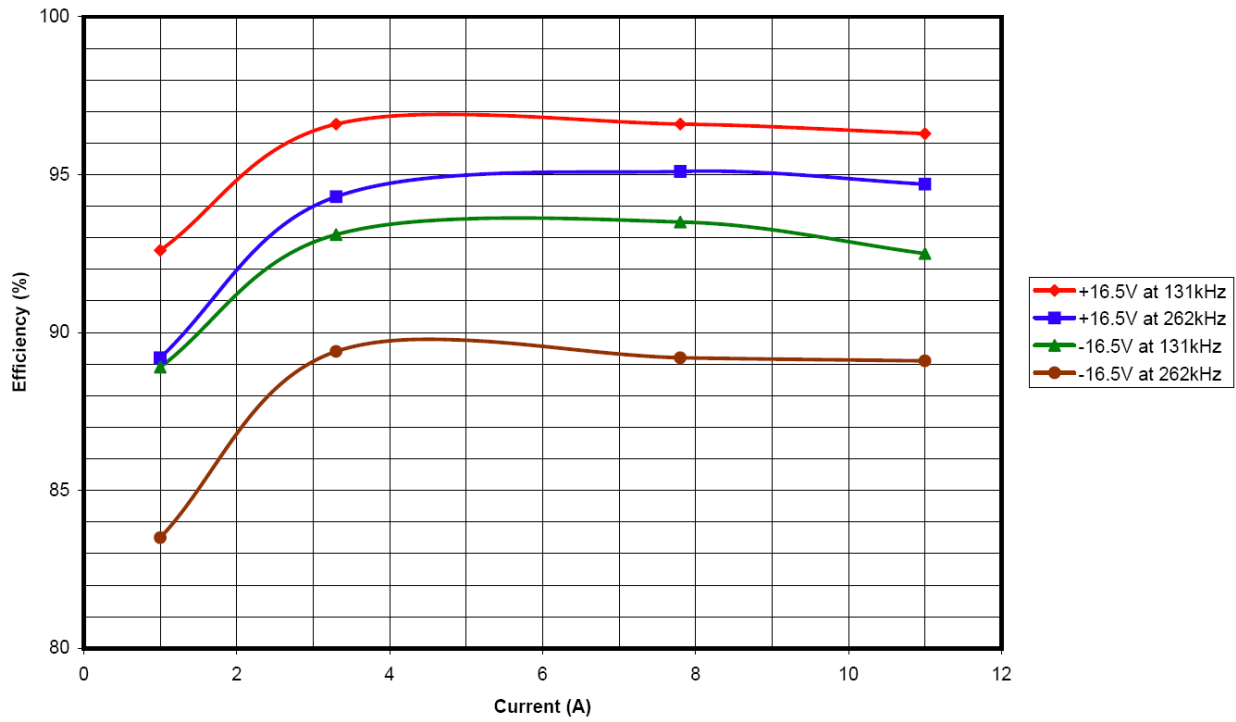

Figure 6: Picture of the synchronous buck regulator.

Plots for efficiencies, total loss and maximum temperatures as function of load current are shown in Fig. 7 and Fig. 8. The data were taken with a PM version implementing revision B at $\pm 16.5V$. Fig. 8 also shows a FLIR image of the module with 8A load on each rail. The circuit board was mounted on a 1.5" x 1.5" aluminum bar which served as a heatsink. The hottest points are the top MOSFETs of the negative rail.

Efficiencies at 48V input
D060431 rev. B



Loss at 48V input
D060431 rev. B

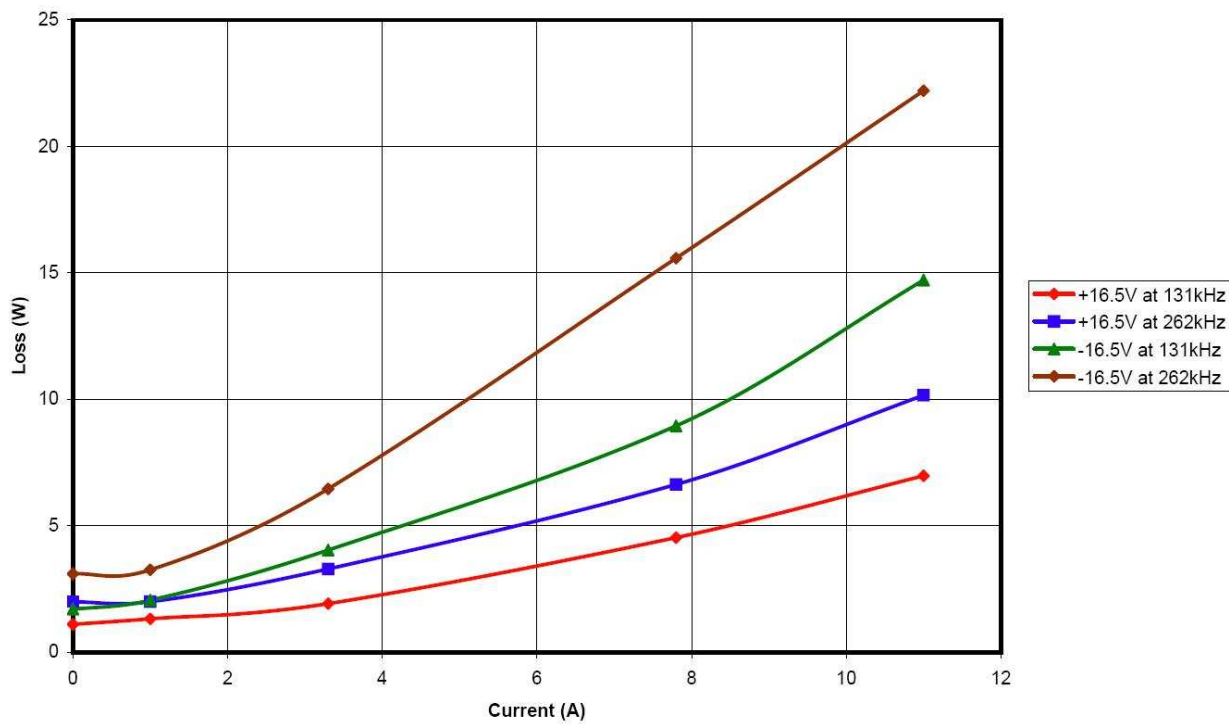

Figure 7: Efficiency and loss for synchronous buck regulator: PM version at 16.5V.

Temperatures at 48V input
D060431 rev. B

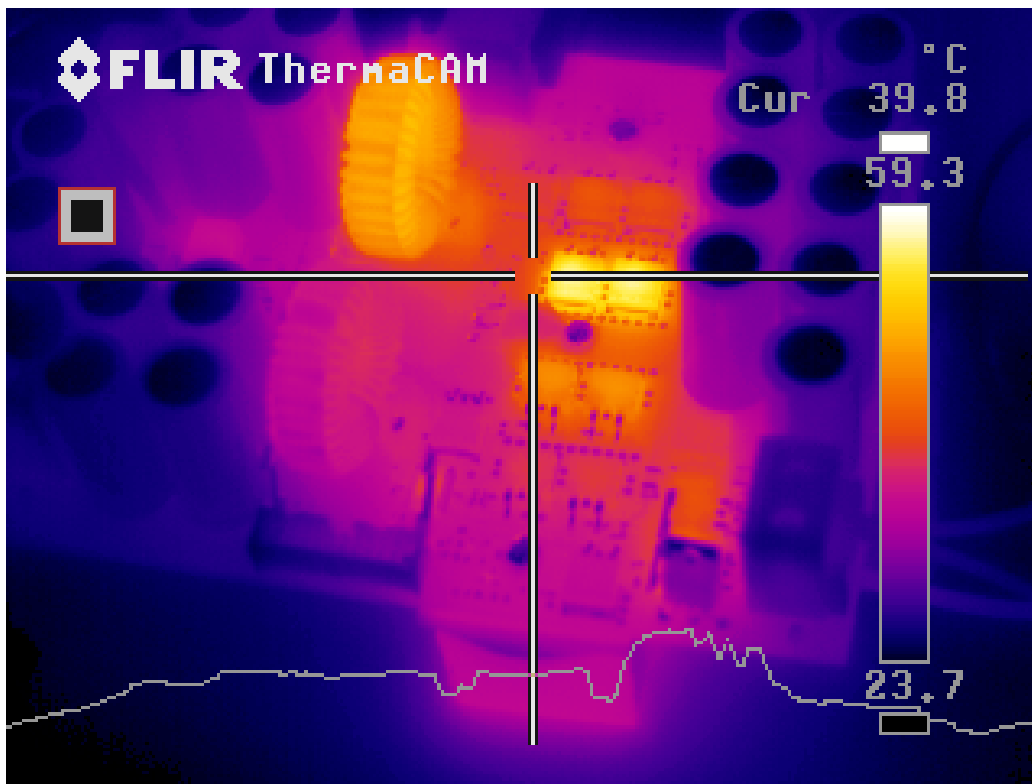
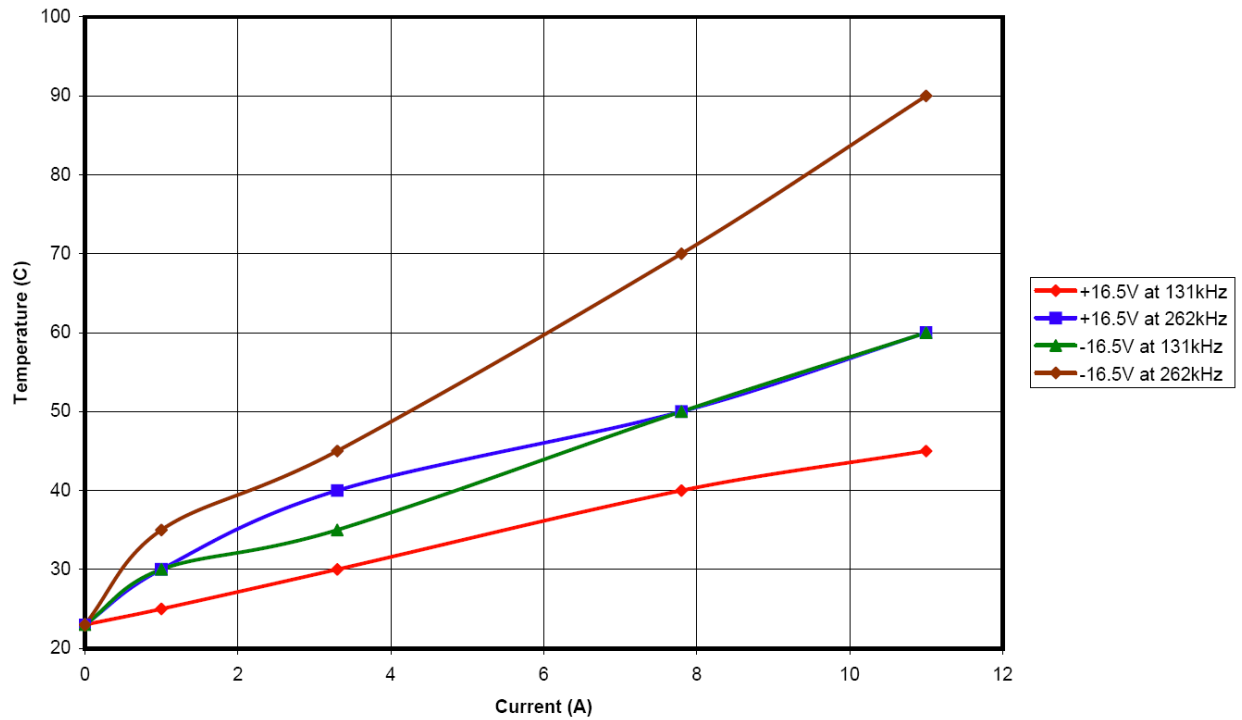
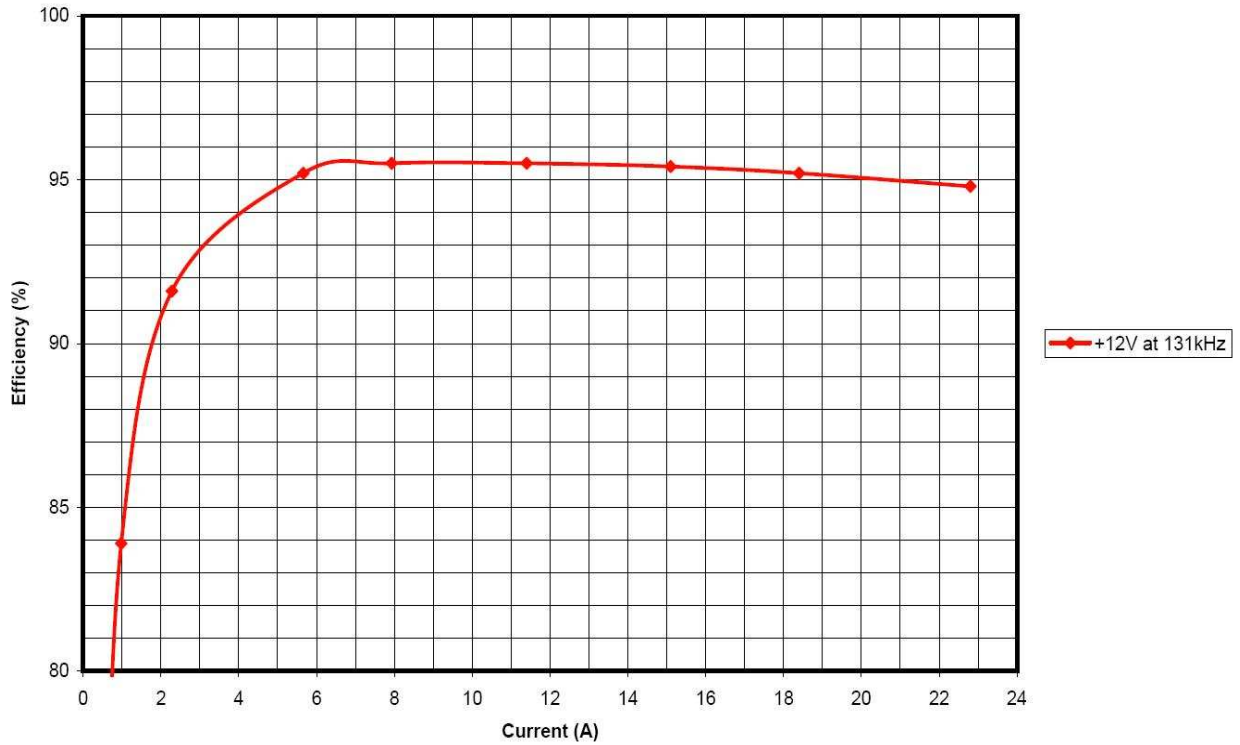

Figure 8: Maximum temperature of the synchronous buck regulator: PM version at 16.5V. The FLIR image shows the module loaded with 8A on each rail.

Similar plots are represented in Fig. 9 and Fig. 10 for the PP version at +12V. The current sense error rises from about -4% at low load to about $+4\%$ at maximum load. The temperature coefficient of the resistivity of copper is about $0.4\%/^{\circ}\text{C}$ which most likely explains the observed effect.

The plots for the $\pm 24\text{V}$ supply are shown in Fig. 11 and Fig. 12. Due to the current limit and the saturation of the coil the maximum current of the -24V rail is 8A with the current limit kicking in around 8.6A.

Efficiencies at 48V input
D060512 rev. A



Loss at 48V input
D060512 rev. A

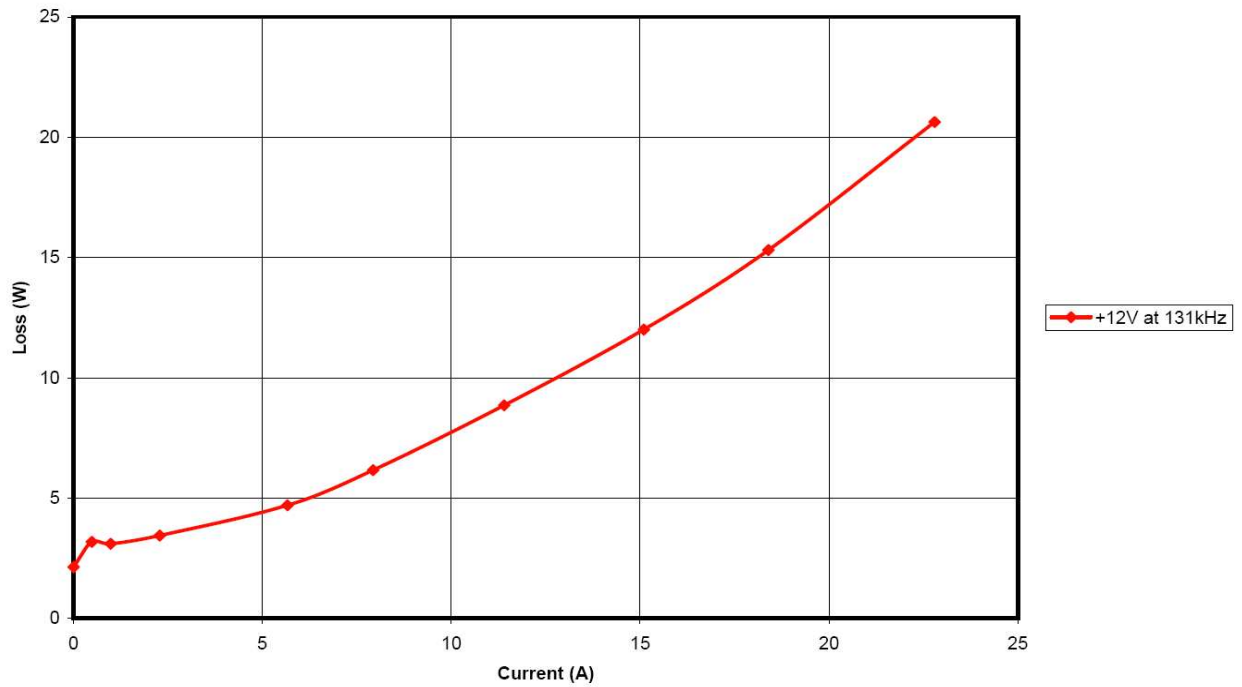
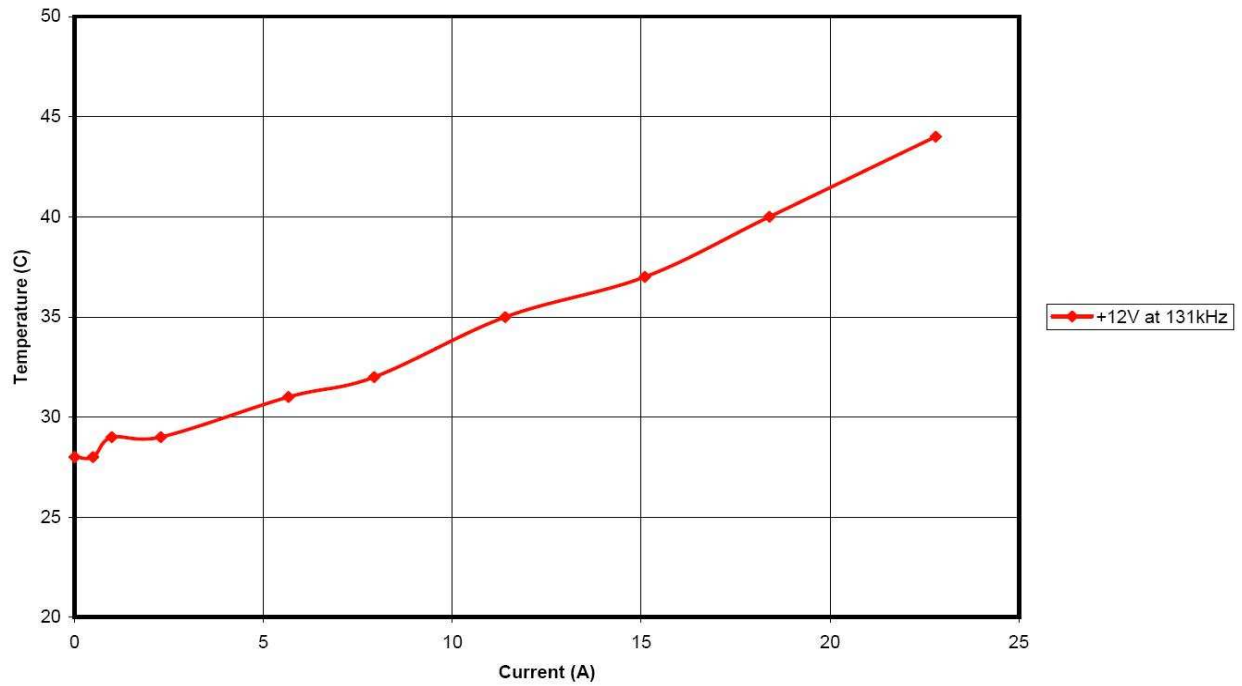

Figure 9: Efficiency and loss for synchronous buck regulator: PP version at 12V.

Temperatures at 48V input
D060512 rev. A



Current Readback for +12V

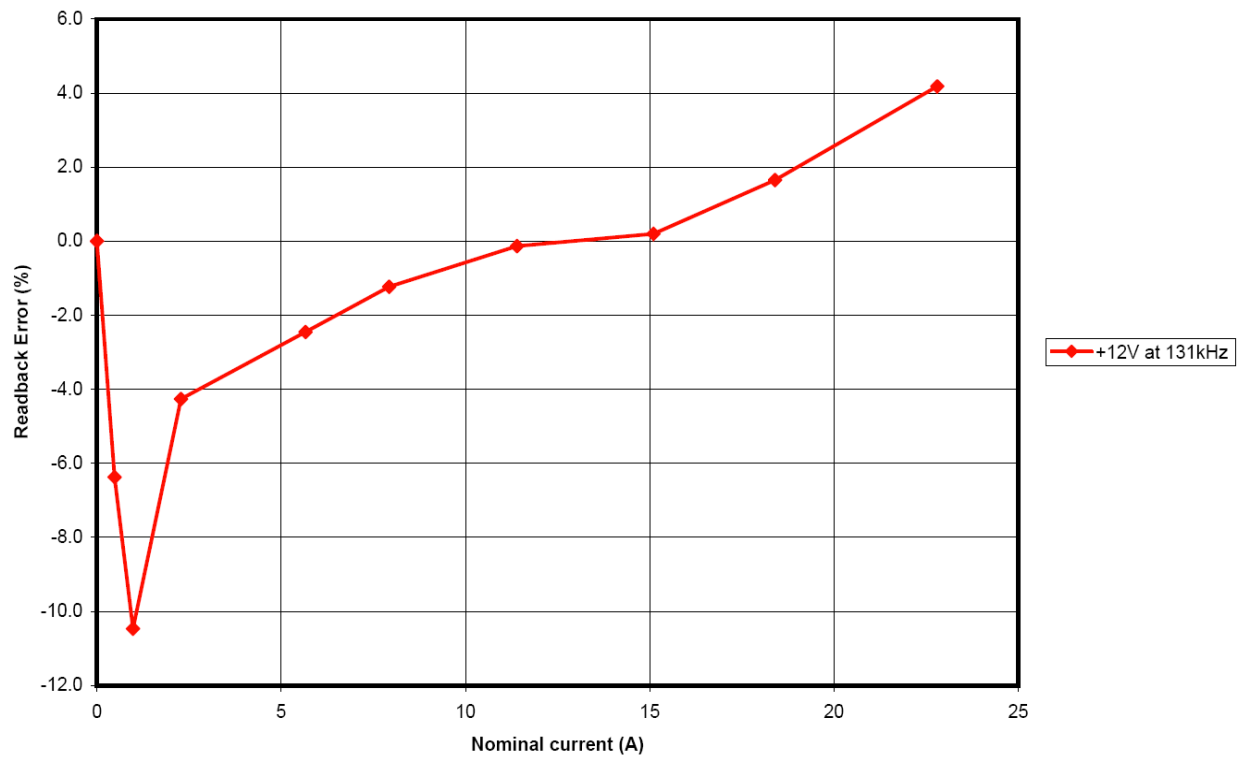
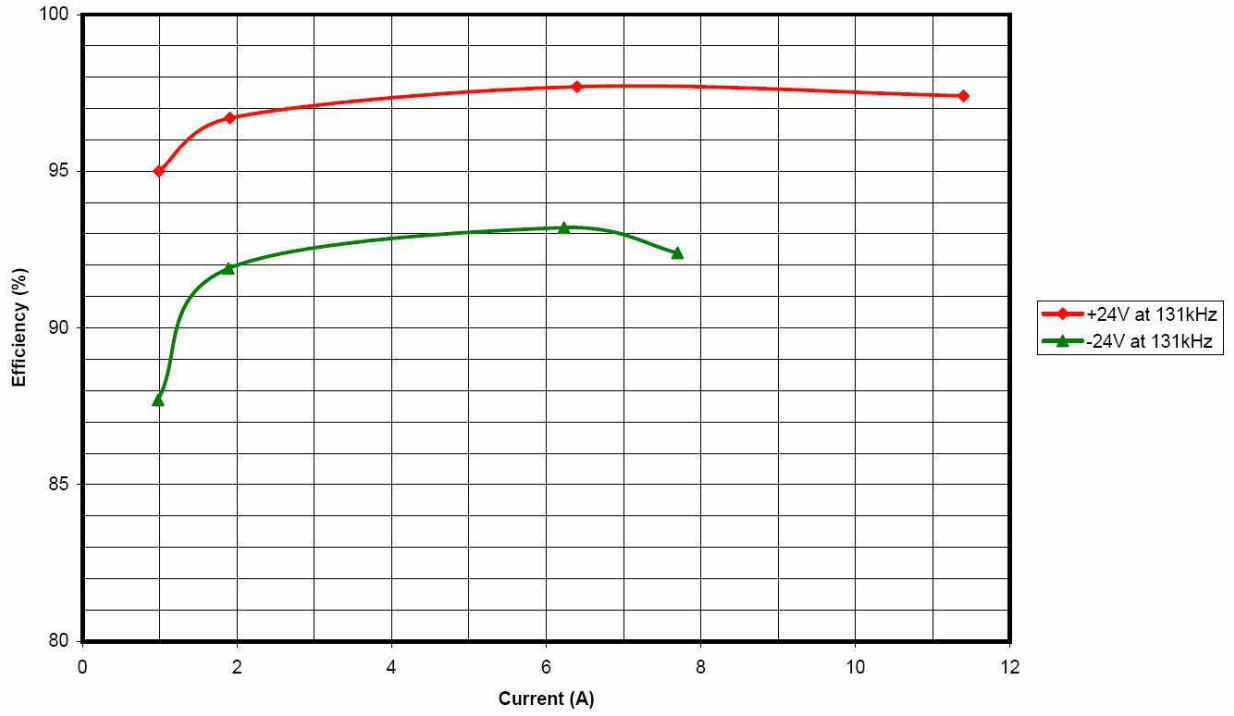

Figure 10: Maximum temperature of the synchronous buck regulator: PP version at 12V. The current sense readback error is shown in the lower plot.

Efficiencies at 48V input
D060431 rev. C



Loss at 48V input
D060431 rev. C

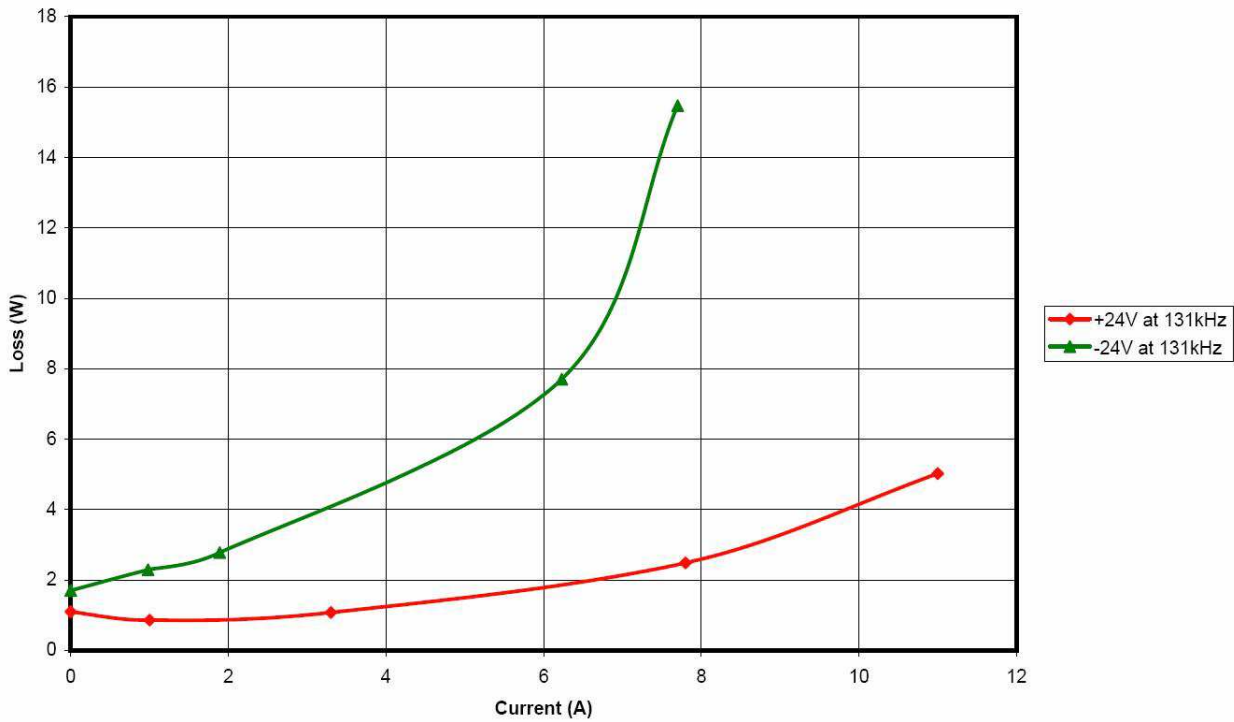

Figure 11: Efficiency and loss for synchronous buck regulator: PM version at 24V.

Temperatures at 48V input
D060431 rev. C

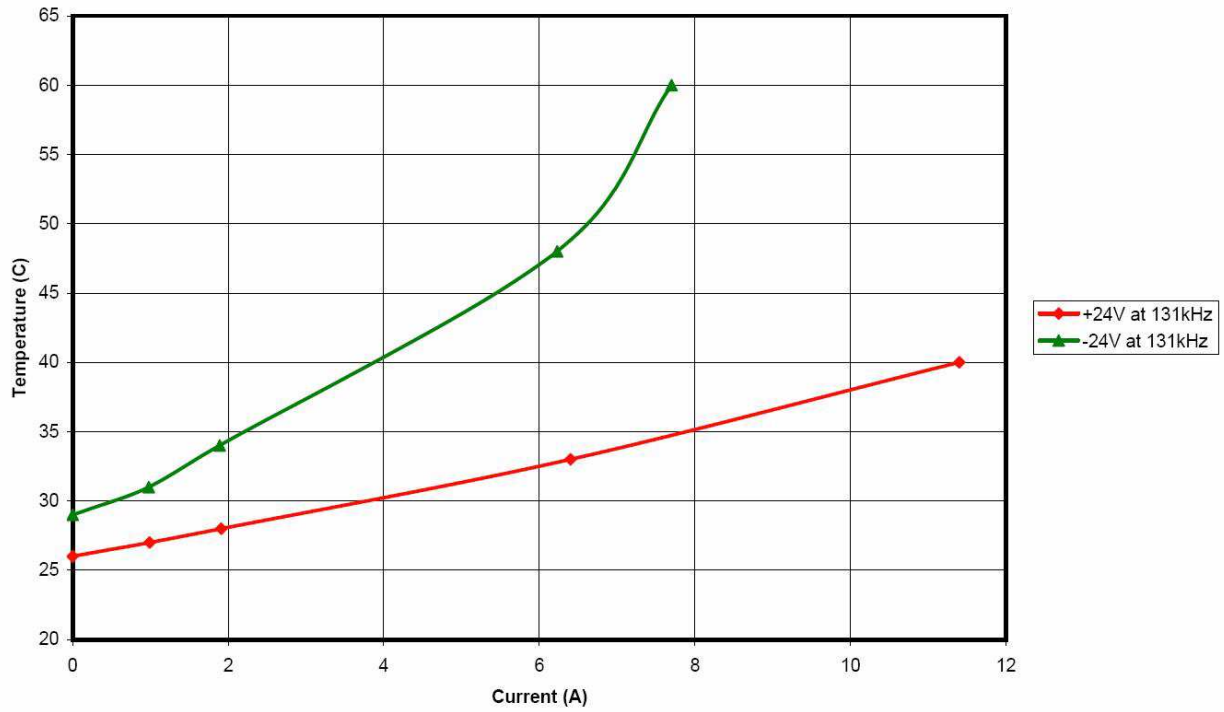

Figure 12: Maximum temperature of the synchronous buck regulator: PM version at 24V.