

LASER INTERFEROMETER GRAVITATIONAL WAVE OBSERVATORY
- LIGO -
CALIFORNIA INSTITUTE OF TECHNOLOGY
MASSACHUSETTS INSTITUTE OF TECHNOLOGY

| | | |
|--|-------------------|-------------|
| Technical Note | LIGO-T070224-00-D | May 8, 2007 |
| Enhanced LIGO TCS CO₂ Laser Intensity Servo Requirements | | |
| Rana Adhikari, Tobin Fricke, Phil Willems | | |

Distribution of this document:

LIGO Scientific Collaboration

Draft

California Institute of Technology
LIGO Project, MS 18-34
Pasadena, CA 91125
Phone (626) 395-2129
Fax (626) 304-9834
E-mail: info@ligo.caltech.edu

Massachusetts Institute of Technology
LIGO Project, Room NW17-161
Cambridge, MA 02139
Phone (617) 253-4824
Fax (617) 253-7014
E-mail: info@ligo.mit.edu

LIGO Hanford Observatory
Route 10, Mile Marker 2
Richland, WA 99352
Phone (509) 372-8106
Fax (509) 372-8137
E-mail: info@ligo.caltech.edu

LIGO Livingston Observatory
19100 LIGO Lane
Livingston, LA 70754
Phone (225) 686-3100
Fax (225) 686-7189
E-mail: info@ligo.caltech.edu

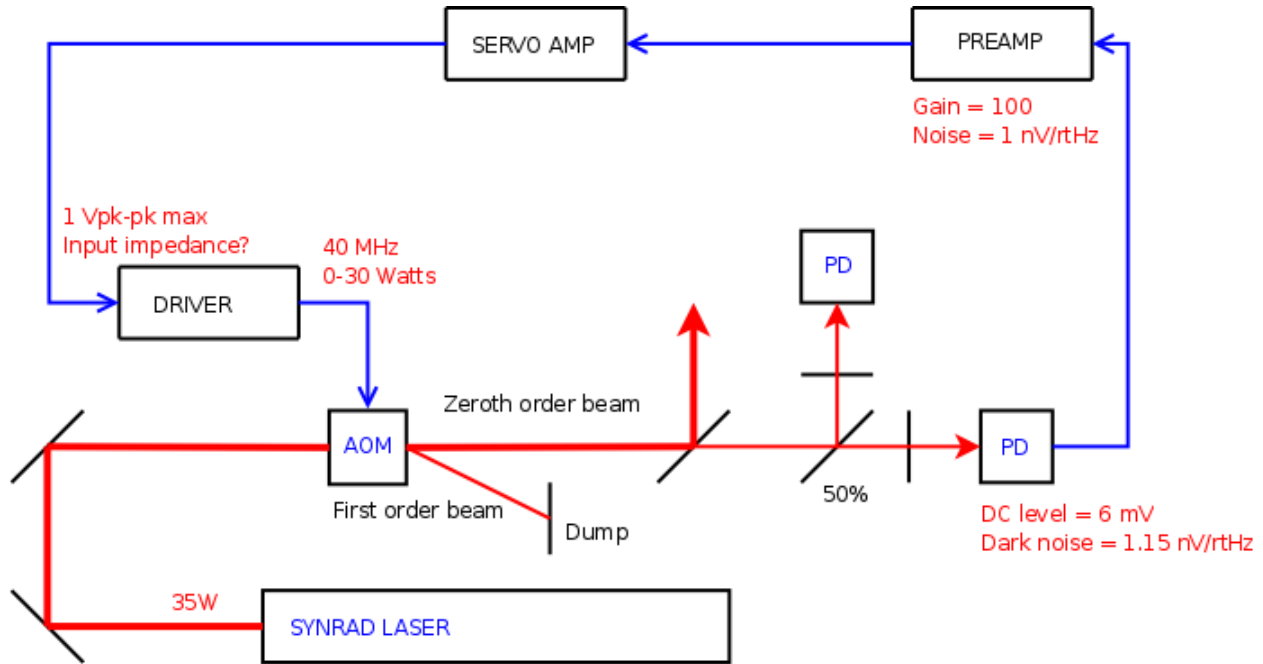

Figure 1: Block diagram of the intensity stabilization servo

1 Introduction

Enhanced LIGO's [2] increased laser power is expected to entail a requirement for increased power [8] from the thermal compensation system (TCS, [4]). At this increased TCS power, thermoacoustic noise from the CO_2 laser is expected to become significant unless measures are taken to stabilize the intensity of CO_2 lasers used for TCS. This document describes requirements for an intensity stabilization servo designed to reduce the thermoacoustic noise to an acceptable level.

The servo operates by dumping excess power via an acousto-optic modulator (AOM). A pick-off of the main CO_2 laser beam (having already passed through the AOM) is directed to a photodiode which provides a measurement of the current intensity of the light. This signal is amplified and filtered and fed back to the AOM.

A block diagram of this scheme is shown in figure 1; the proposed optical table layout is shown in figure 2.

1.1 Estimated TCS power requirement for Enhanced LIGO

The required TCS power may be computed from:

- The absorption of the ITM optics

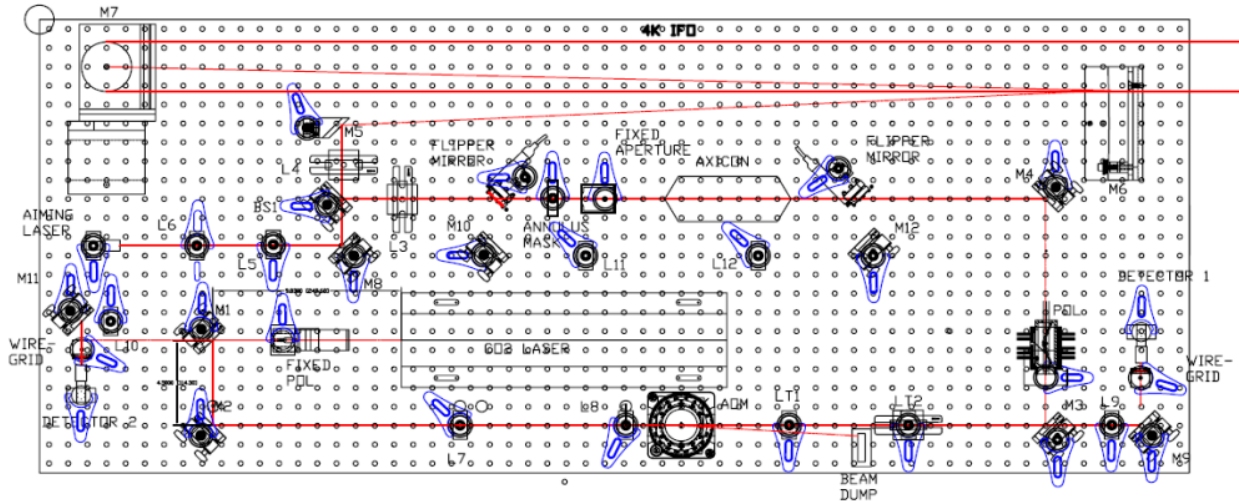

Figure 2: Table layout

- The power in the cavity
- Annular versus central heating factor. (Approximately 11 watts of annular CO_2 power is needed to compensate for every watt absorbed centrally in the substrate.)

The absorption of the test masses has been measured by tracking the frequencies of thermal resonances, as described in [8] and excerpted in Figure 3. These measurements give an estimated absorption of 7 ± 5 ppm for all optics. (These measurements will be repeated using an improved technique during the S5 post-run investigations period.

The circulating power in initial LIGO's final science run was 25 kW for H1 and 17 kW for L1 [5]. Multiplying these by 4, we find approximately 100 kW and 68 kW for the stored power in H1 and L1, respectively, during Enhanced LIGO.

| I/O | Optic | YAG absorption | Cavity power | Absorbed power | Annular power req. |
|-----|-------|----------------|--------------|------------------|---------------------------|
| H1 | ITMX | 7 ± 5 ppm | 100 kW | 700 ± 500 mW | 7.7 ± 5.5 W annular |
| H1 | ITMY | | 100 kW | | |
| H1 | ETMX | | 100 kW | | N/A |
| H1 | ETMY | | 100 kW | | N/A |
| L1 | ITMX | | 68 kW | 476 ± 340 mW | 5.23 ± 3.74 W annular |
| L1 | ITMY | | 68 kW | | |
| L1 | ETMX | | 68 kW | | N/A |
| L1 | ETMY | | 68 kW | | N/A |

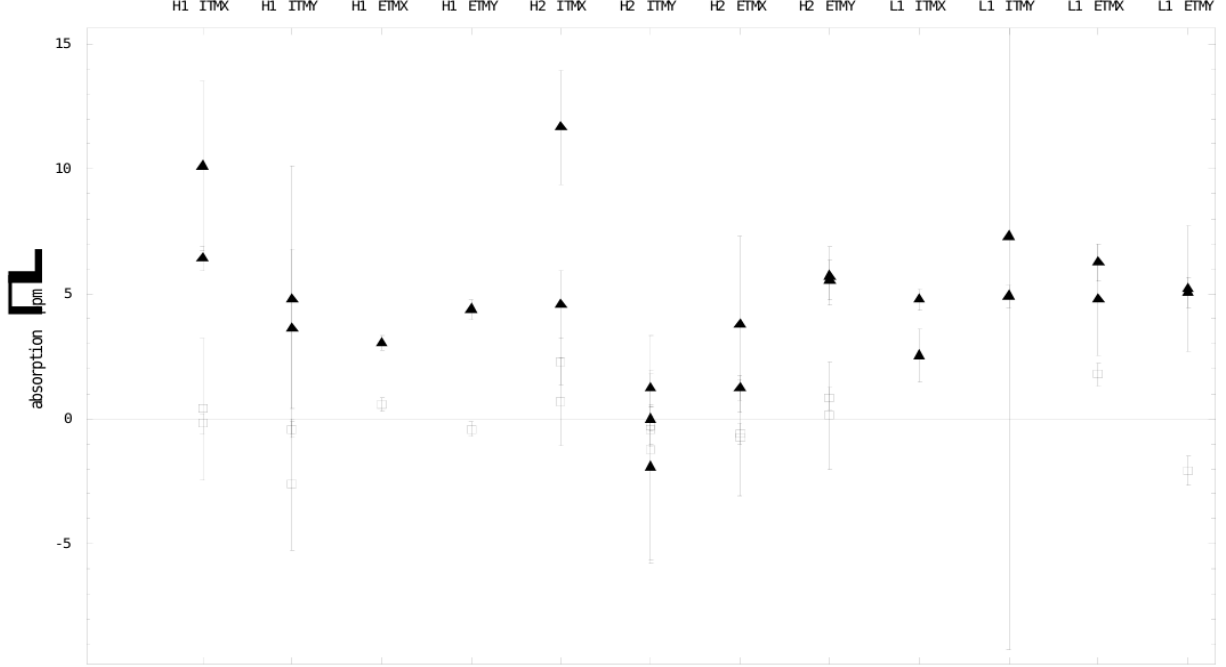

Figure 3: Results of absorption measurements using thermal line tracking (from [8]). The triangles represent measurements of absorption; the empty squares are control measurements which should be consistent with zero.

1.2 TCS laser intensity noise requirements

The coupling of TCS laser noise to displacement noise (see equations 2.45 and 2.46 in [3]) in the interferometer due to the thermoelastic effect is given by

$$n(f) = \frac{\alpha P}{f} RIN \quad (1)$$

where P is the average TCS power (in watts) absorbed in the optic, f is the frequency of interest, RIN is the relative intensity noise (in $1/\sqrt{\text{Hz}}$) of the TCS laser, and where

$$\alpha = \begin{cases} 1.5 \times 10^{-11} m \text{ Hz/W} & \text{central heating} \\ 2.1 \times 10^{-12} m \text{ Hz/W} & \text{annular heating} \end{cases} \quad (2)$$

These relations can be used to turn the Enhanced reference noise curve [1] into a requirement on the relative intensity noise of the TCS lasers. Figure 4(A) shows the maximum TCS RIN allowed, assuming 7.7 watts of CO_2 power applied annularly, subject to the criterion that the thermoelastic noise must be less than one-tenth the Enhanced LIGO reference noise curve. Conversely, the expected noise contribution of TCS due to the thermoelastic effect is shown Figure 4(B), again assuming 7.7 watts CO_2 power applied annularly.

As seen in the figure, the requirement on TCS laser RIN is most stringent in the band 40 – 300Hz, in which the TCS laser RIN must be below $8 \times 10^{-8} \text{ Hz}^{-1/2}$.

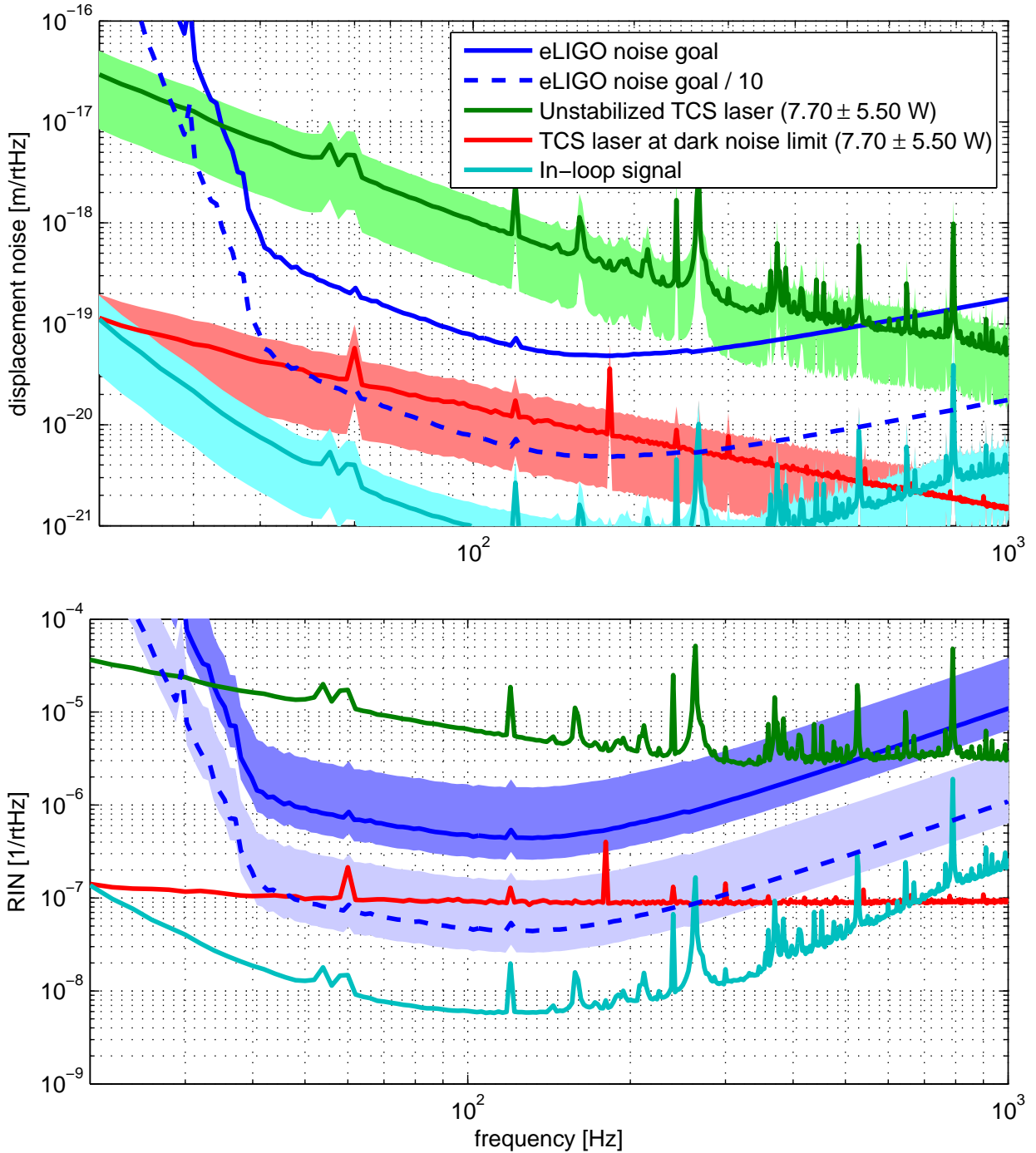

Figure 4: (A) S6 noise goal with TCS thermoelastic noise superimposed; (B) Same data as in (a) but in units of RIN.

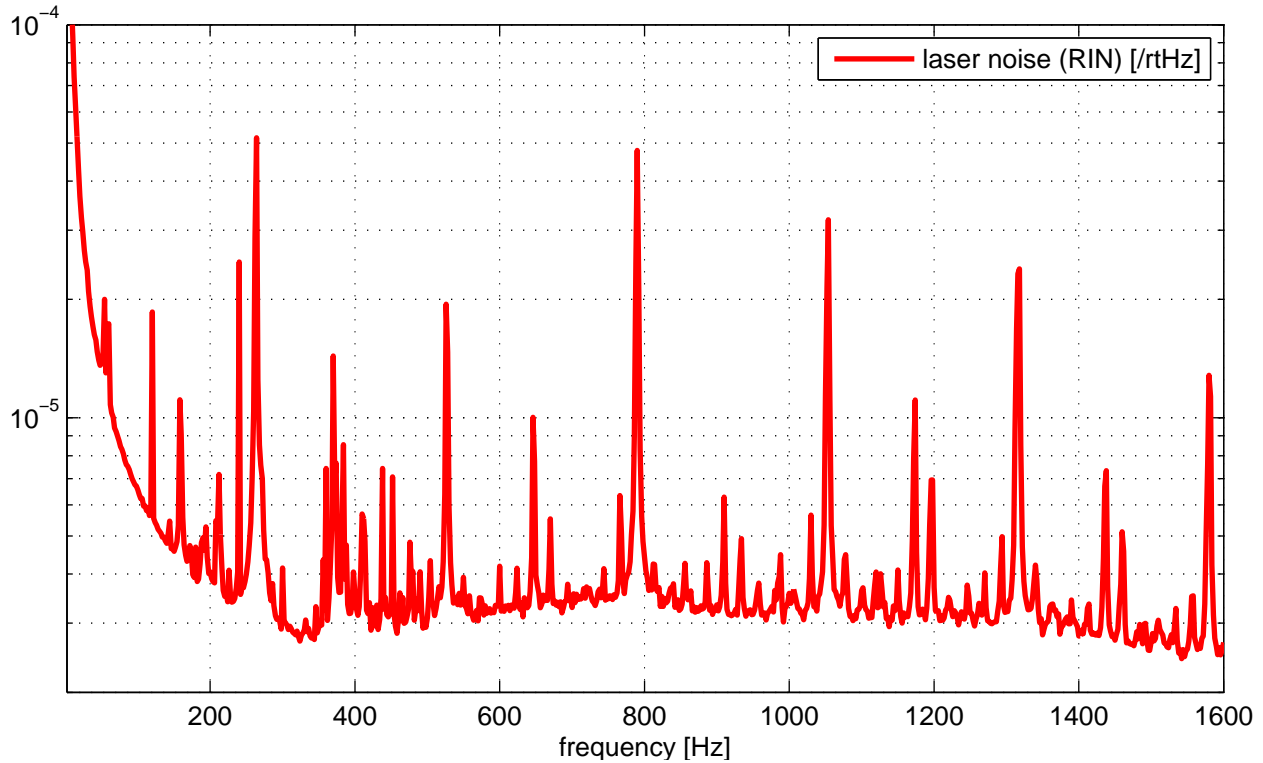

Figure 5: RIN of unstabilized laser

2 Components

| | | |
|------------|---------------------------|-------------|
| AOM | IntraAction | AGM – 406B1 |
| AOM Driver | IntraAction | GE – 4030 |
| Laser | Synrad | J48 – 2W |
| PD | Boston Electronics / VIGO | PVM – 10.6 |
| Preamp | “Rai’s Low Noise Pre-Amp” | D060205 |

2.1 Laser

The laser currently under investigation is the Synrad J48-2W, which produces 35 watts of $10.6\mu\text{m}$ radiation. The measured intensity noise of this laser without any intensity stabilization is shown in Figure 5.

2.2 Photodiode

The photodiode in use is a HgCdTe diode selected by Rai Weiss[7], manufactured by VIGO System S.A. in Warsaw, Poland and purchased through Boston Electronics. At saturation, the diode is expected to have a DC signal of approximately 10 mV. (The dark noise curve

in Figs 1 and 2 was taken with a DC level of 7 mV from the diode.) The dark noise of the diode is about 1.1 nV/rtHz, corresponding to a RIN of 1.1×10^{-7} /rtHz at 10mV.

2.3 Preamp

The preamp is a variant of “Rai’s Low Noise Preamp,” which utilizes an LT1128 low-noise opamp preceded by an Interfet IF3602 ultra-low-noise dual FET stage. Currently 1.5 nV/rtHz is achieved, but better performance should be possible. 0.7 nV/rtHz is expected.

2.4 Servo amplifier

2.4.1 Design

To push the noise spectrum below one-half of the sensor noise we need a suppression of 200. This can be provided by a servo with the following (open loop) parameters:

| | |
|--------------|-------------------------------|
| poles | 40, 100 ⁴ , 250 Hz |
| zeros | 0 ² , 7, 1500 Hz |
| UGF | 1 and 8902 Hz |
| Phase Margin | 61 degrees |

An open-loop bode plot is shown in Figure 6; a closed loop plot is shown in Figure 7. These plots include the phase delay due to the AOM.

2.4.2 Implementation

The proposed servo board is a filter board developed by Nick Smith and Thomas Corbitt at MIT for use on a ponderomotive squeezing experiment there[6]. The board provides four channels. Each channel consists of a differential input received through a BNC connector, an AD829 acting as an inverting differential receiver, an AD600/602 variable gain amplifier, an AD829 inverting gain stage, four AD829 filter stages, an ADG333 switch, and finally an AD829 inverting gain stage. The output is through a D-sub connector.

The AD600 produces a maximum amplitude output of 2.5 volts, with 1.4 nV/rtHz input-referred noise. Its maximum input amplitude is one volt.

The board requires a bipolar 24 volt power supply.

Figure shows an integrated RMS amplitude of the control signal of about 2 mV, assuming

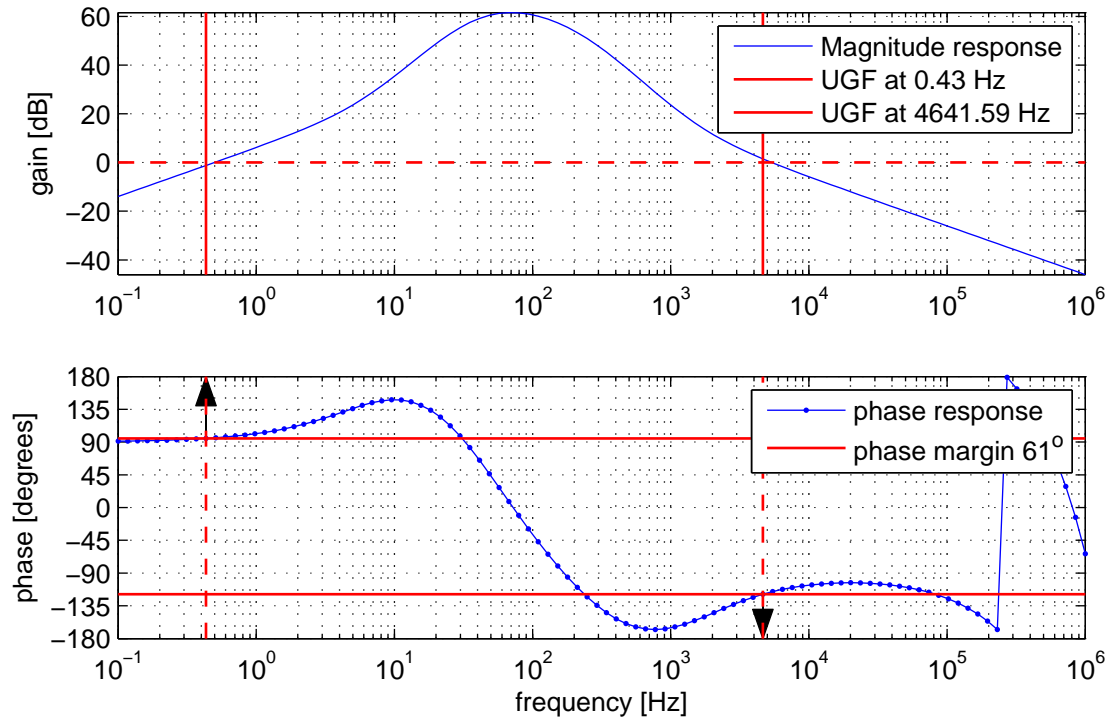

Figure 6: Open loop transfer function of proposed servo loop

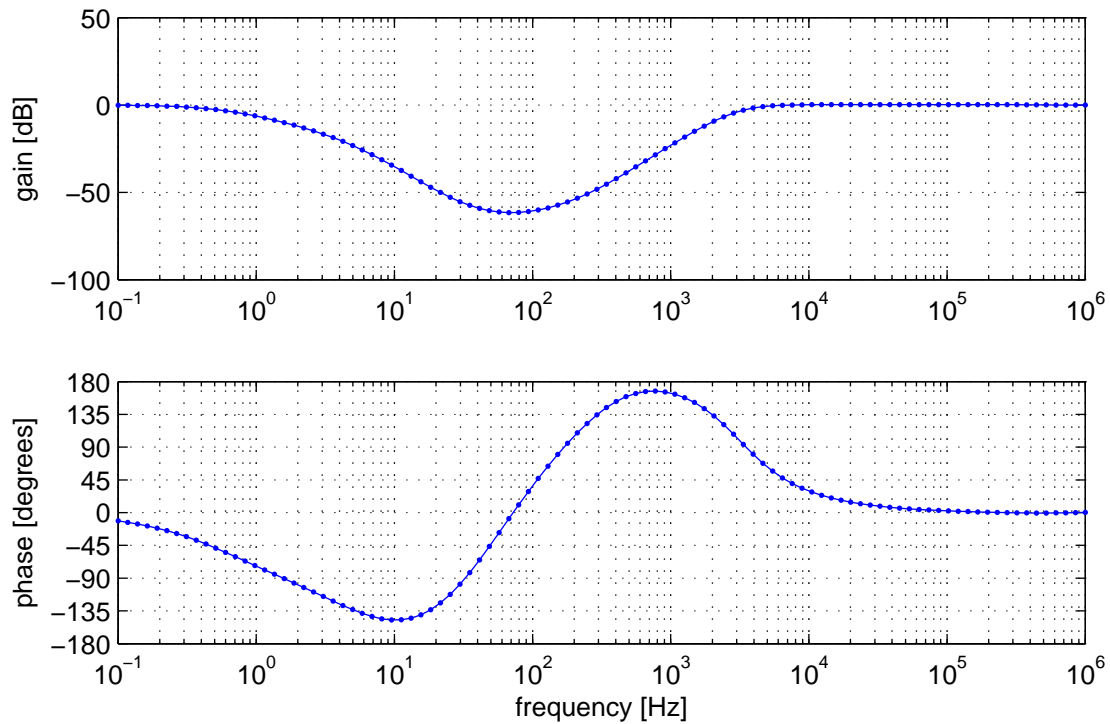

Figure 7: Closed loop transfer function of proposed servo loop

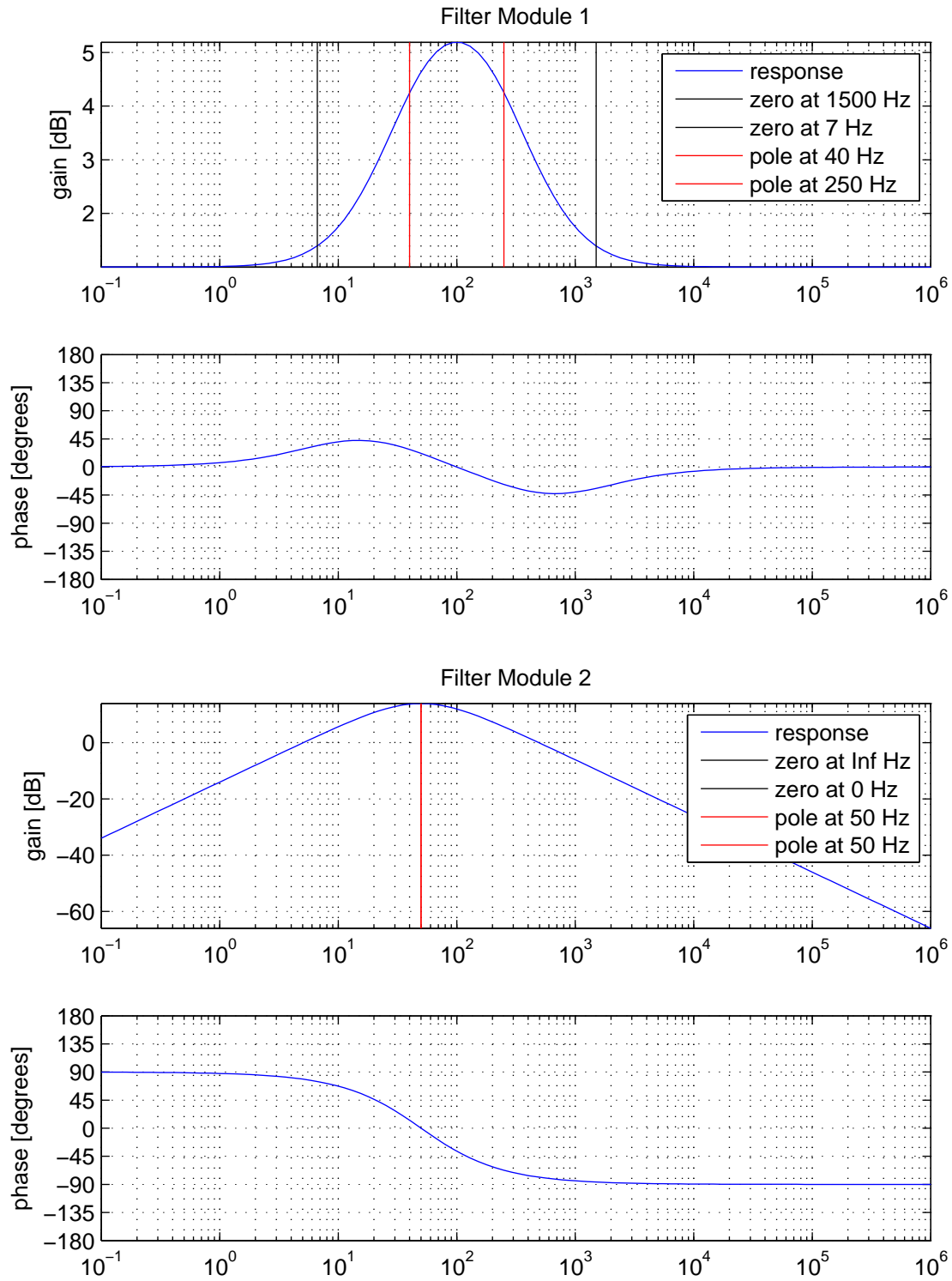

Figure 8: Filter modules for proposed servo amplifier

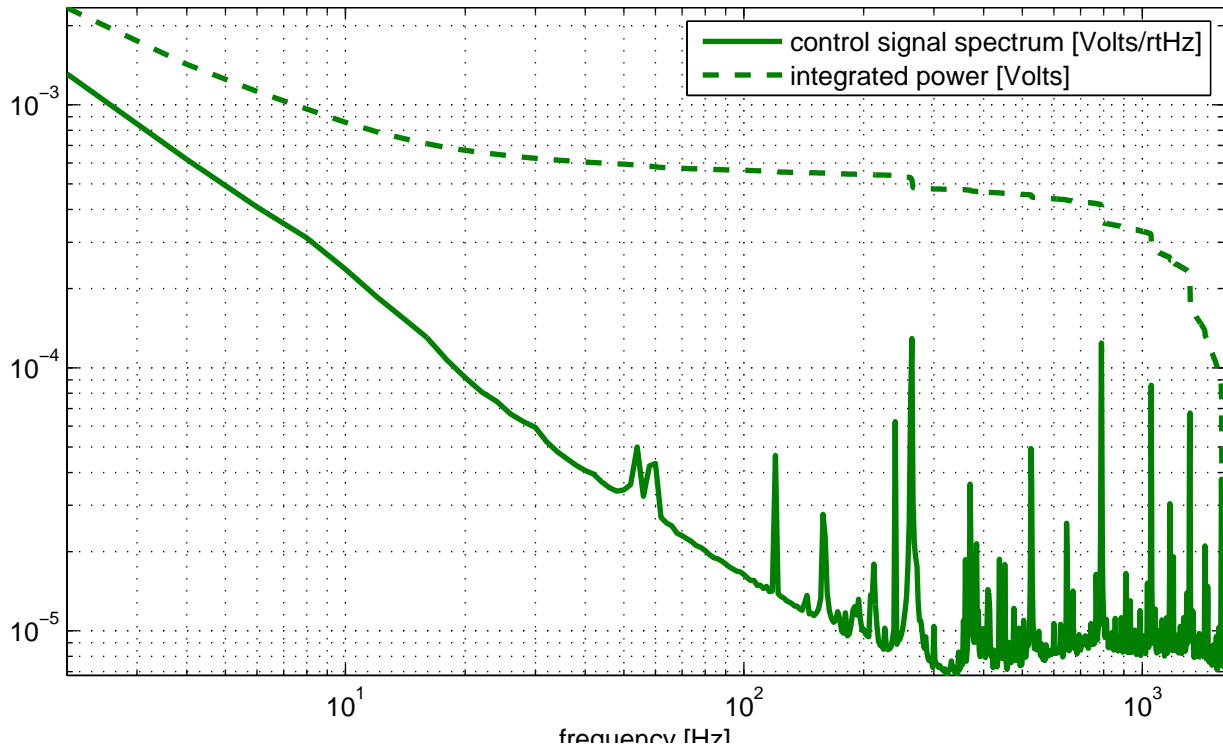

Figure 9: Spectrum of control signal

an operating point of 100 mV for the AOM.

2.5 AOM

The AOM driver nominally takes a 0 – 1 volt input signal. There is also a DC offset adjustment on the driver. In practice the DC offset will be adjusted to set the operating point of the AOM.

The measured AOM transmissivity and calculated responsivity are shown in figures 10 and 11, respectively. The AOM utilizes a germanium crystal in which the speed of sound is 5400 m/s. The phase lag due to the AOM, assuming that the beam is located 5mm from the transducer, is given in Figure 12.

3 Cooling requirements

The Synrad J48-2W laser’s datasheet specifies a max heat load of 500 watts for the J48-2 laser. They also specify a coolant flow rate requirement of 0.8 GPM at 18-22 degrees Celsius and an electrical draw of 14 amps at 30 volts DC (420 watts).

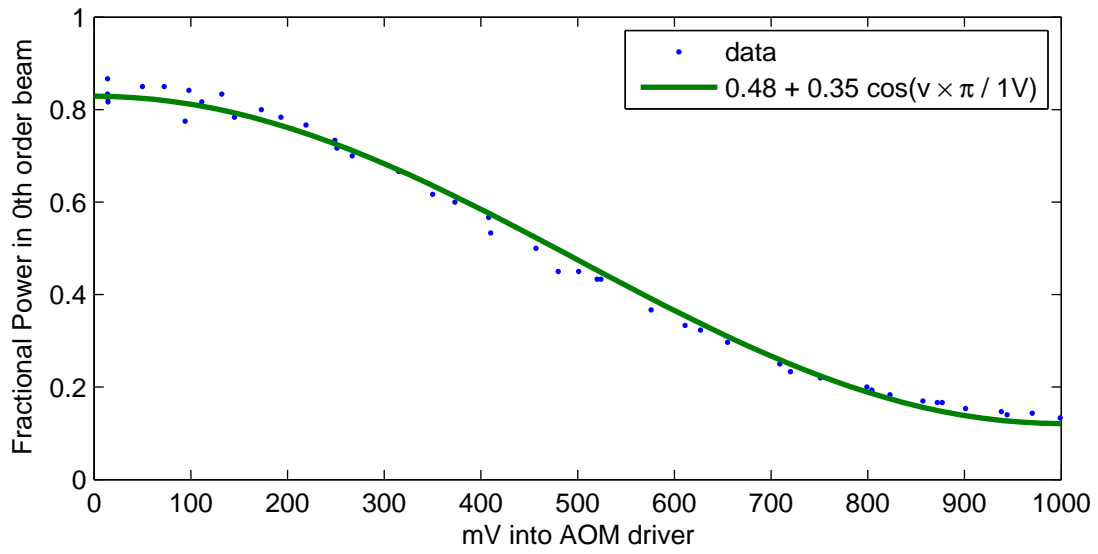

Figure 10: AOM transmissivity

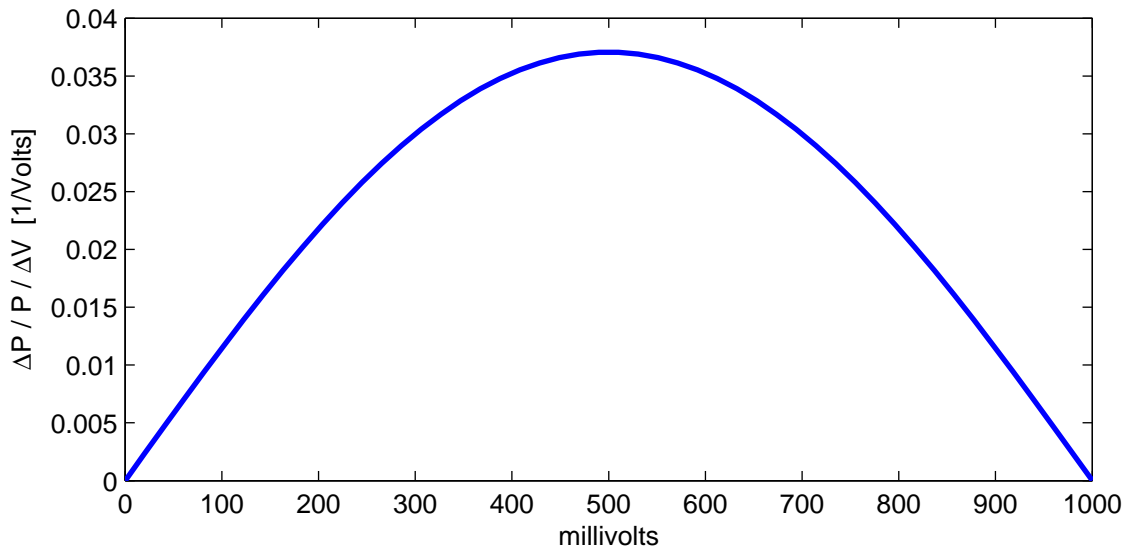

Figure 11: AOM responsivity

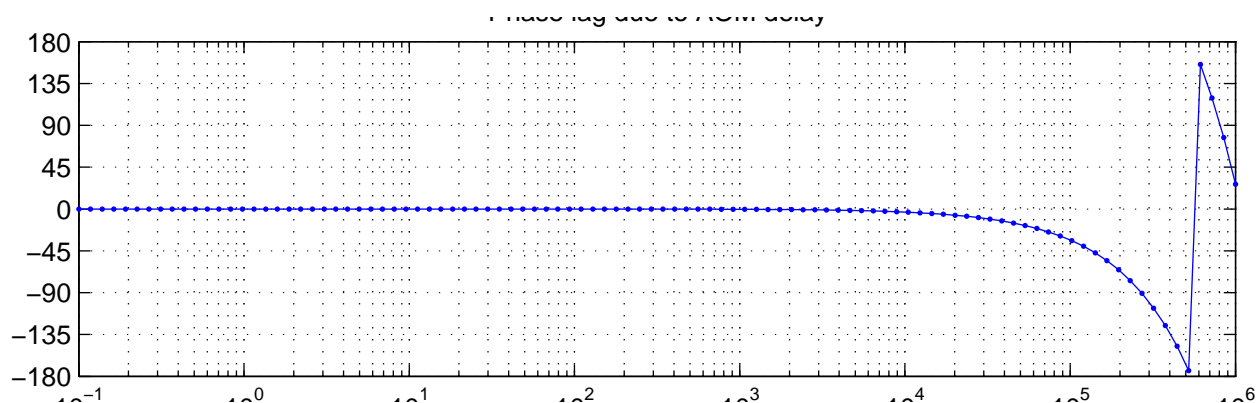

Figure 12: AOM phase lag

There is also the AOM. Its datasheet specifies a coolant flow of 500 ml/min at 20°C. It dissipates a maximum of 30 watts RF drive plus 12% (specified) optical insertion loss, which is 4 watts for a 35 watt input beam.

The chiller in the TCS lab right now is a PolyScience Recirculator model 6206P. The datasheet says it can provide 800 watts cooling capacity at 20°C.

References

- [1] Rana Adhikari. http://www.ligo.caltech.edu/~rana/NoiseData/S6/DC_strain_noise.txt.
- [2] Rana Adhikari, Peter Fritschel, and Sam Waldman. Enhanced LIGO. Technical Report LIGO-T060156-01-I, July 2006.
- [3] Stefan Ballmer. *LIGO Interferometer operating at design sensitivity with application to gravitational radiometry*. PhD thesis, MIT, June 2006.
- [4] Stefan Ballmer, Valery Frolov, Ryan Lawrence, William Kells, Gerardo Moreno, Ken Mason, David Ottaway, Mike Smith, Cheryl Vorvick, Phil Willems, and Mike Zucker. Initial LIGO Thermal Compensation System description. Technical Report LIGO-T050064, 2005.
- [5] Peter Fritschel. Ligo: The laser interferometer gravitational-wave observatory. Technical Report LIGO-P070082, 2007.
- [6] Nick Smith and Thomas Corbitt. <http://emvogil-3.mit.edu/~tcorbitt/fb.pdf>.
- [7] Rai Weiss. 10 micron detectors for CO₂ amplitude stabilization. Technical report, MIT, May 2005.
- [8] Phil Willems. Thermal compensation in LIGO. Number G070146-00, 03 2007. March 2007 LSC Meeting.