

LASER INTERFEROMETER GRAVITATIONAL WAVE OBSERVATORY
- LIGO -
CALIFORNIA INSTITUTE OF TECHNOLOGY
MASSACHUSETTS INSTITUTE OF TECHNOLOGY

Document Type LIGO-T960151-01 - C 8/7/97
Large and Small Optics Suspension Electronics Design Requirements
J. Heefner

Distribution of this draft:

D. Barker, R. Bork, R. Abbott, S. Kawamura, D. Ouimette

This is an internal working note
of the LIGO Project.

California Institute of Technology
LIGO Project - MS 51-33
Pasadena CA 91125
Phone (818) 395-2129
Fax (818) 304-9834
E-mail: info@ligo.caltech.edu

Massachusetts Institute of Technology
LIGO Project - MS 20B-145
Cambridge, MA 01239
Phone (617) 253-4824
Fax (617) 253-7014
E-mail: info@ligo.mit.edu

WWW: <http://www.ligo.caltech.edu/>

Abstract

This technical note describes the design requirements for the LIGO Large and Small Optics Suspension (LOS and SOS) electronics.

1 INTRODUCTION

1.1. Purpose

The purpose of this technical note is to describe and document the design requirements for the LIGO Large and Small Optics Suspension Electronics

1.2. Scope

This document covers the design and performance requirements for all electronics hardware and software to be used for the suspension controls of the LIGO Large and Small Optics.

1.3. Definitions

Suspension Controller- In the context of this document the suspension controller refers to the suspension controller module.

1.4. Acronyms

- ASC- Alignment Sensing and Control
- CDS- Control and Data System
- LED- Light Emitting Diode
- LIGO- Laser Interferometer Gravitational-wave Observatory
- LL- Lower left suspension coil or photodiode
- LOS- Large Optics Suspension
- LR- Lower right suspension coil or photodiode
- LSC- Length Sensing and Control
- MTBF- Mean Time Between Failure
- MTTR- Mean Time To Repair
- PD- Photodiode
- PIT- Pitch of optic being controlled
- POS- Longitudinal position of optic being controlled
- S- Lateral position of optic being controlled
- SOS- Small Optics Suspension
- TBD- To Be Determined
- UL- Upper left suspension coil or photodiode
- UR- Upper right suspension coil or photodiode
- YAW- Yaw of optic being controlled

1.5. Applicable Documents

1.5.1. LIGO Documents

- *Suspension Design Requirements*- LIGO T950011
- *Vacuum Feedthrough and Cabling Design Requirements*- LIGO T950095
- *LIGO Vacuum Compatibility, Cleaning Methods and Procedures*-LIGO E960022
- *Requirements of LOS Suspension Driver*, S. Kawamura memo to J. Heefner- LIGO-L960728
- *Requirements of SOS Suspension Driver*, S. Kawamura memo to J. Heefner- LIGO-L970006
- *Suspension Preliminary Design*- LIGO T960074

1.5.2. Non-LIGO Documents

2 GENERAL DESCRIPTION

2.1. Product Perspective

The suspension controller electronics described in this document specify the servo electronics, controls and monitors that form the large and small optic suspension control systems for LIGO.

A block diagram of the suspension control electronics is shown in the figure below. Devices covered by this requirements document are shown within the shaded region.

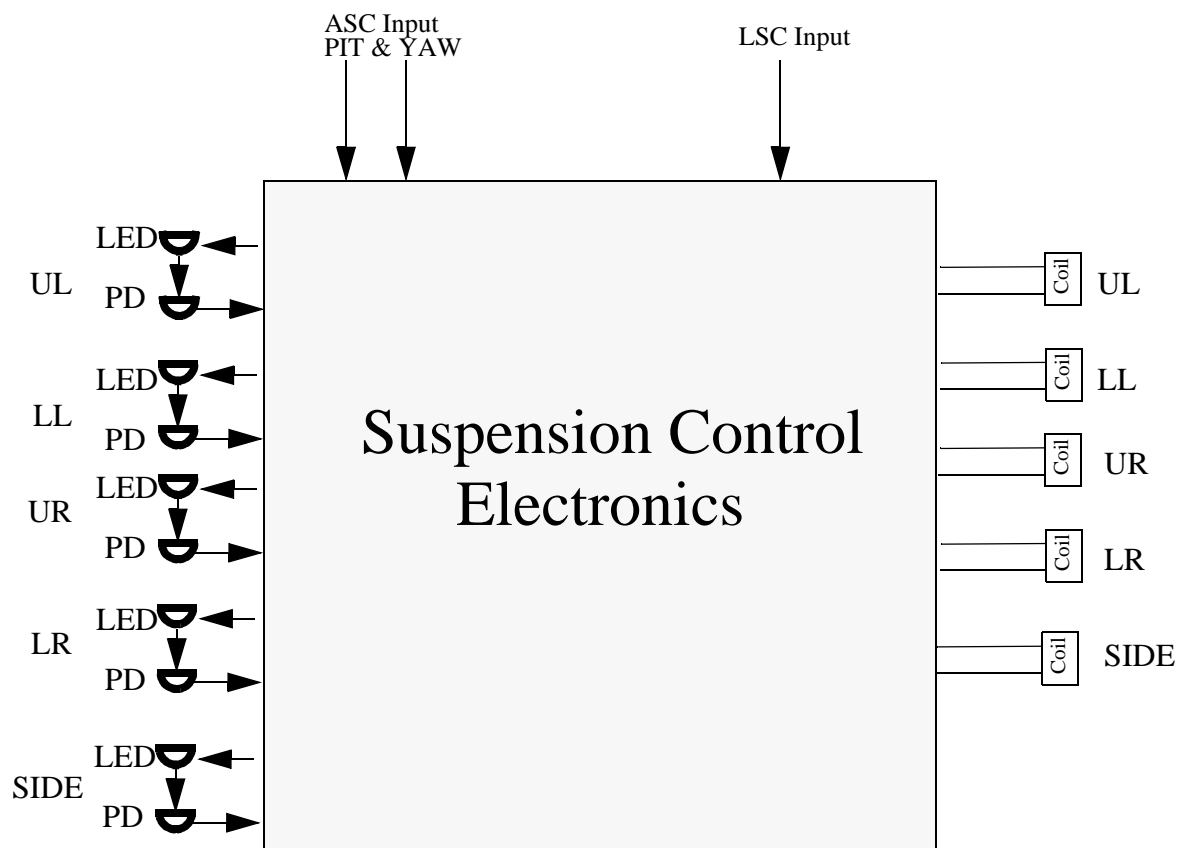

Figure 1: Schematic diagram of the electronic system of the suspension control.

2.2. Product Functions

The suspension controller electronics can be separated into two functional components: the photodiode/LED electronics and the suspension controller itself. The function of each is described below.

2.2.1. Photodiode/LED Electronics

The photodiode/LED electronics provide for the local read back of optic orientation and position that is used for control in the local control mode described in the sections that follow. Each coil has associated with it a photodiode and LED pair as shown in Figure 1: Schematic diagram of the electronic system of the suspension control. The function of the electronics is to provide a constant current source to the LED and convert the photodiode current to a voltage for use by the suspension controller.

2.2.2. Suspension Controller

The function of the suspension controller is to provide a damped optic for use in the interferometer. In addition, the suspension controller provides a means by which other systems such as ASC and LSC can control the pitch, yaw, and longitudinal position of the optic.

The performance requirements and characteristics of the large and small optics suspension controllers are specified in the respective sections that follow. Interfaces to the ASC and LSC systems are described in the interfaces section of this document.

2.3. General Constraints

2.3.1. Equipment Locations

The electronics for the suspension controllers shall be located in a 19 inch rack. The location of the racks for each set of suspension control electronics is TBD. Line drivers or preamplifiers that may be used to boost signals closer to the optics being controlled may be mounted within cable trays or under optical tables near the LIGO Vacuum Equipment Chambers.

2.3.2. Vacuum Cabling and Devices Internal to the Vacuum Chamber

Vacuum cabling, connectors, feedthroughs and devices internal to the vacuum chamber must adhere to the vacuum qualification, cleaning and maintenance procedures that have been established for LIGO. The design requirements for vacuum cabling and feedthroughs are listed in LIGO T950095.

2.3.3. LEDs, Photodiodes and Coil Cross Section

The LEDs, photodiodes and coil cross section have been determined as part of the preliminary design (LIGO T960074) of the suspension system. They are as follows:

- LED: TLN107A, Toshiba, no outgas was observed after being baked at 70°C .
- PD: TPS703A, Toshiba, no outgas was observed after being baked at 70°C .
 - Distance between PD and LED: 6 mm
- Coil
 - Wire size: **TBD (wire size and the number of turns will be determined as part of the design ref. section 3.1.1.2.4 and 3.1.1.3.4, but will maintain the same coil cross section)**
 - Coil size: 7.66 mm ID, 12.66 mm OD, 5 mm L
- Housing
 - Material: Macor¹, gold-plated
 - Size: 25.3 mm OD x 25.4 mm L (SOS), 25.3 mm OD x 48.3 mm L (LOS)
 - Wire clamp: Wires wrapped around a screw which is threaded into back of the head housing.

1. Machinable glass ceramic: manufactured by Corning.

2.4. Assumptions and Dependencies

3 REQUIREMENTS

3.1. Characteristics

3.1.1. Performance Characteristics

3.1.1.1 Photodiode and LED Electronics

It should be noted that the requirements for LOS and SOS photodiode and LED electronics are identical.

3.1.1.1.1 LED Drive Current

The electronics shall provide a constant current of 10 mA¹ to each of the LEDs. This current shall be accurate to +/- 1% and be stable to better than 1% over the full temperature range specified in the sections below.

Output referred current noise shall be less than $(100pA)/(\sqrt{Hz})$ for frequencies greater than 0.1 Hz.

3.1.1.1.2 Photodiode Current to Voltage Conversion

The transimpedance of each photodiode pre-amplifier (5 total) shall be 20 Kohms, +/- 1%². The output referred voltage noise shall be limited by the Johnson noise of the 20 Kohm transimpedance (better than $(17nV)/(\sqrt{Hz})$) for frequencies greater than 10 Hz.

3.1.1.2 Large Optic Suspension

3.1.1.2.1 LOS Local Damping Transfer Function

The design of the LOS controller shall provide for “pseudo-critical” damping³ of the optic in the local damping and control mode of operation.

3.1.1.2.2 LOS ASC Input to Actuator Coil Transfer Function

The gain from the ASC pitch or yaw input of the controller to the optic under control shall be 25μrad/Volt. The design shall be such that the gain of each ASC input (PIT_{ASC} and YAW_{ASC}) can be trimmed by the operator from the nominal gain +/-25% in minimum 0.5% increments.

-
1. 10 mA is half of the maximum specified current for the LEDs. No intensity degradation was observed for 16 LEDs for three years in the 100 m prototypes in Japan.
 2. 20 Kohms was chosen to make the PD shot noise the dominant noise source and not have saturation of the amplifiers
 3. Pseudo-critical damping: no bump in the transfer function of force to displacement with suitable gain.

The shape of the output filter transfer function shall be a 35 Hz, fourth order, 4 dB passband ripple 60 dB stopband attenuation elliptic low pass filter.

The input referred noise of the ASC inputs of the controller shall be less than $(1\mu V)/(\sqrt{Hz})$ for freq <40 Hz.

3.1.1.2.3 LOS LSC Input to Actuator Coil Transfer Function

The transfer function from the LSC input of the controller to the optic under control shall be 1.0μmeter/Volt at DC. The design shall be such that the gain of each LSC input can be trimmed by the operator from the nominal gain +/-25% in minimum 0.5% increments.

The shape of the transfer function shall include a pole at 1.0 Hz and a zero at 40 Hz with no other poles or zeros for freq < 10 KHz.

The input referred noise of the LSC input of the controller shall be less than $(TBD\mu V)/(\sqrt{Hz})$ for freq <40 Hz.

The length control input shall have three modes of operation that shall be selectable by the operator. The acquisition and locked modes are as defined in Table 2:

- Acquisition mode
- Locked mode
- Off Mode: LSC Input Disabled

3.1.1.2.4 LOS Dynamic Range and Input and Output Noise

For frequencies below 40 Hz the input referred noise of the controller shall be dominated by the LED/PD sensor noise. If the sensor noise is assumed to be $1 \times 10^{-10} ((m)/(\sqrt{Hz}))$ and the transimpedance of the photodiode amplifier is 20 KV/A, this would lead to:

$$v_{noise} \ll \left(1 \times 10^{-10} \left(\frac{m}{\sqrt{Hz}} \right) \times 08 \frac{\dot{A}}{m} \times 20K \frac{V}{A} = 160n \frac{V}{\sqrt{Hz}} \right)$$

Therefore, the input referred noise of the controller should be less than $16((nV)/(\sqrt{Hz}))$ for frequencies less than 40 Hz.

The dynamic range and output noise of the controller shall be as defined in Table 1 below.

Table 1: LOS Controller Dynamic Range and Output Noise

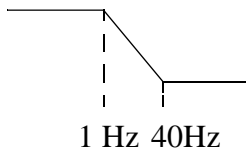
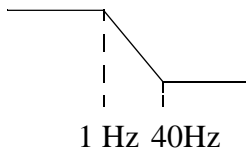
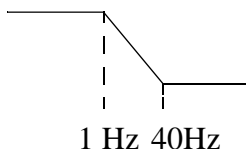
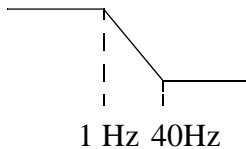
	<i>Mode of Operation</i>	<i>Dynamic Range</i>	<i>Output Noise</i>
Local Damping and Control	Local damping and control mode	$20 \mu m_{p-p}$  1 Hz 40Hz	$5 \times 10^{-20} \left(\frac{f}{40} \right)^{-2} (m / (\sqrt{Hz}))$ $f > 40 \text{ Hz}$ **
ASC Pitch Input to Optic	All modes	$500 \mu rad_{p-p}$  1 Hz 40Hz	$1 \times 10^{-17} ((rad) / (\sqrt{Hz}))$ $f > 40 \text{ Hz}$
ASC Yaw Input to Optic	All modes	$500 \mu rad_{p-p}$  1 Hz 40Hz	$1 \times 10^{-17} ((rad) / (\sqrt{Hz}))$ $f > 40 \text{ Hz}$
LSC Input to Optic	LSC Acquire	$20 \mu m_{p-p}$ Flat response	N/A
LCS Input to Optic	LSC Locked	$20 \mu m_{p-p}$  1 Hz 40Hz	$5 \times 10^{-20} \left(\frac{f}{40} \right)^{-2} (m / (\sqrt{Hz}))$ $f > 40 \text{ Hz}$

**Memo L960728-00-D, “Requirements of the LOS Suspension Driver”, S. Kawamura, outlines the dynamic range and noise requirements for the LOS controller and the trade-off that can be made between the number of actuator coil windings, the maximum output current drive and the output referred current noise.

3.1.1.3 Small Optic Suspension

3.1.1.3.1 SOS Local Damping Transfer Function

The design of the SOS controller shall provide for “pseudo-critical” damping of the optic in the local damping and control mode of operation.

The design shall provide for adjustment of each of the nominal gains +20/-40 dB in minimum 1 dB increments.

3.1.1.3.2 SOS ASC Input to Actuator Coil Transfer Function

The gain from the ASC pitch or yaw input of the controller to the optic under control shall be 150urad/Volt. The design shall be such that the gain of each ASC input (PIT_{ASC} and YAW_{ASC}) can be trimmed by the operator from the nominal gain +/-25% in minimum 0.5% increments.

The shape of the output filter transfer function shall be a 35 Hz, fourth order, 4 dB passband ripple 60 dB stopband attenuation elliptic low pass filter.

The input referred noise of the ASC inputs of the controller shall be less than $(1\mu V)/(\sqrt{Hz})$ for freq <40 Hz.

3.1.1.3.3 SOS LSC Input to Actuator Coil Transfer Function

The transfer function from the LSC input of the controller to the optic under control shall be 4umeter/Volt at DC. The design shall be such that the gain of each LSC input can be trimmed by the operator from the nominal gain +/-25% in minimum 0.5% increments.

The shape of the transfer function shall include a pole at TBD Hz and a zero at 40 Hz with no other poles or zeros for freq < 10 KHz.

The input referred noise of the LSC input of the controller shall be less than $(TBD\mu V)/(\sqrt{Hz})$ for freq <40 Hz.

The length control input shall have three modes of operation that shall be selectable by the operator. The modes are defined as:

- Acquisition mode: Maximum range of the controller TBD umeter. 1Hz pole and 40 Hz zero removed from coil driver response.
- Locked mode: Maximum range +/- 40 umeter.
- Off Mode: LSC Input Disabled

3.1.1.3.4 SOS Dynamic Range and Input and Output Noise

For frequencies below 40 Hz the input referred noise of the controller shall be dominated by the LED/PD sensor noise. If the sensor noise is assumed to be $1 \times 10^{-10} ((m)/(\sqrt{Hz}))$ and the transimpedance of the photodiode amplifier is 20 KV/A, this would lead to:

$$v_{noise} \ll \left(1 \times 10^{-10} \left(\frac{m}{\sqrt{Hz}} \right) \times 08 \frac{\dot{A}}{m} \times 20 K \frac{V}{A} = 160n \frac{V}{\sqrt{Hz}} \right)$$

Therefore, the input referred noise of the controller should be less than $16((nV)/(\sqrt{Hz}))$ for frequencies less than 40 Hz.

The dynamic range and output noise of the controller shall be as defined in Table 2 below.

Table 2: SOS Controller Dynamic Range and Output Noise

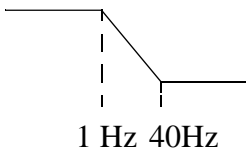
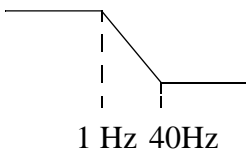
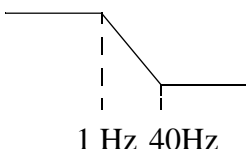
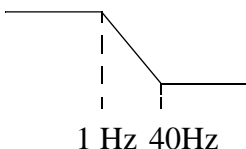
	<i>Mode of Operation</i>	<i>Dynamic Range</i>	<i>Output Noise</i>
Local Damping and Control	Local damping and control mode	$80\mu m_{p-p}$  1 Hz 40Hz	$3.8 \times 10^{-18} \left(\frac{f}{40}\right)^{-2} (m/(\sqrt{Hz}))$ $f > 40 \text{ Hz}$ **
ASC Pitch Input to Optic	All modes	3 mrad_{p-p}  1 Hz 40Hz	$1 \times 10^{-17} ((rad)/(\sqrt{Hz}))$ $f > 40 \text{ Hz}$
ASC Yaw Input to Optic	All modes	3 mrad_{p-p}  1 Hz 40Hz	$1 \times 10^{-17} ((rad)/(\sqrt{Hz}))$ $f > 40 \text{ Hz}$
LSC Input to Optic	LSC Acquire	$80 \mu\text{meter}$ Flat response	N/A
LCS Input to Optic	LSC Locked	$80\mu m_{p-p}$  1 Hz 40Hz	$3.8 \times 10^{-18} \left(\frac{f}{40}\right)^{-2} (m/(\sqrt{Hz}))$ $f > 40 \text{ Hz}$

**Memo L970006-00-D, "Requirements of the SOS Suspension Driver", S. Kawamura, outlines the dynamic range and noise requirements for the LOS controller and the trade-off that can be made between the number of actuator coil windings, the maximum output current drive and the output referred current noise.

3.1.1.4 Basis Transformations (Small and Large Optic Suspension)

3.1.1.4.1 Local Input Basis Transformation Matrix

Testing on the 40 meter interferometer has determined that the input matrix used by the local damping servo loop do not need to be adjustable by the operator. The nominal calculation of POS, PIT and YAW shall be as follows:

- $POS = UL + LL + UR + LR$
- $PIT = (UL + UR) - (LL + LR)$
- $YAW = (UL + LL) - (UR + LR)$

The design shall such that the “balance” for each channel is within 1% on the nominal calculation.

3.1.1.4.2 Output Basis Transformation

The nominal calculation of outputs UL, LL, UR, LR from POS, PIT and Yaw are as follows:

- $UL = POS + PIT + YAW$
- $LL = POS - PIT + YAW$
- $UR = POS + PIT - YAW$
- $LR = POS - PIT - YAW$

The design shall such that the “balance” for each output channel may be trimmed by the operator. For example:

$$UL = C1 \bullet POS + C2 \bullet PIT + C3 \bullet YAW$$

$$LL = C4 \bullet POS - C5 \bullet PIT + C6 \bullet YAW$$

$$UR = C7 \bullet POS + C8 \bullet PIT - C9 \bullet YAW$$

$$LR = C10 \bullet POS - C11 \bullet PIT - C12 \bullet YAW$$

where C1 through C12 are nominally equal to unity, and are adjustable from 0.75 to 1.25 in step sizes of 0.5% minimum.

3.1.1.5 Indicators, Monitors and Controls

3.1.1.5.1 Gain Adjustment and Inversion

The gain of the transfer functions for each type of controller shall be adjustable by the operator. This gain adjustment shall be +20 and -40 dB from the nominal gains stated above in 1 dB steps.

A mechanism shall be provided such that the operator can invert each of the responses described in sections 3.1.1.2 and 3.1.1.3 above.

3.1.1.5.2 Monitors

Monitors, both front panel and computer, shall be provided for the following:

- Output coil currents

- Pitch, yaw and position
- Photodiode output voltages

The bandwidth of front panel monitors shall be greater than 1 KHz. Computer monitors available to the operator display at a maximum 10 Hz rate and minimum 12 bit resolution.

3.1.1.6 Test Inputs, Outputs and Functions

Test inputs, monitors and controls shall be provided such that the closed loop transfer function of the suspension controller servo can be measured while the servo loop is closed.

A means of opening the servo loop and injecting a test signal into suspension controller shall be provided. Opening of the servo loop shall be accomplished without removing cables or disconnecting devices.

An LSC Test Input shall be incorporated into the design.

Individual coil test inputs shall be incorporated into the design.

All test inputs shall have the capability of being disabled by the operator.

3.1.2. Physical Characteristics

3.1.2.1 Locations of Devices

The table below is a summary of the known suspension systems for the LIGO 4 Km interferometers.

Table 3: 4 Km Interferometer Suspension Systems

<i>Type</i>	<i>Quantity</i>	<i>Optic Being Controlled</i>
LOS	7	Beam Splitter Recycling Mirror 2 ea. ITM 2 ea. ETM IOO Mode Matching Mirror
SOS	5	3 ea. IOO Mode Cleaner Mirrors 2 ea. IOO Mode Matching Mirrors

The table below is a summary of the known suspension systems for the LIGO 2 Km interferometer.

Table 4: 2 Km Interferometer Suspension Systems

<i>Type</i>	<i>Quantity</i>	<i>Optic Being Controlled</i>
LOS	9	Beam Splitter Recycling Mirror 2 ea. ITM 2 ea. ETM IOO Mode Matching Mirror 2 ea. Folding Mirrors
SOS	5	3 ea. IOO Mode Cleaner Mirrors 2 ea. IOO Mode Matching Mirrors

3.1.2.2 Electronic Equipment Housings

To the extent possible and reasonable the following shall be applied to the suspension controller electronics.

- All equipment shall be housed in standard 19 inch racks.
- Standard 6U VME enclosures with VME, dummy or split backplanes shall be used, as appropriate, for custom and commercial modules.
- Custom electronics modules shall be 6U VME or 19 inch chassis format and shall follow the design standards imposed by the LIGO CDS group.

3.1.2.3 Cabling and Connections

All cabling and connection of electronics modules and devices shall be in accordance with standard LIGO CDS grounding and shielding policies.

All field cabling shall be run in the cable trays that are provided below the vacuum chamber.

3.1.3. Interface Definitions

3.1.3.1 Interfaces to other LIGO subsystems

3.1.3.1.1 Mechanical Interfaces

The following table summarizes the mechanical interfaces to other LIGO subsystems.

3.1.3.1.2 Electrical Interfaces

The following table summarizes the electrical interfaces to other LIGO subsystems.

Table 5: Mechanical Interfaces to Other LIGO Subsystems

<i>Interface</i>	<i>LIGO Subsystem</i>	<i>Characteristics</i>
Vacuum cabling mount to seismic isolation stacks	seismic isolation	TBD
Vacuum feedthrough connector	vacuum chamber	TBD

Table 6: Electrical Interfaces to Other LIGO Subsystems

<i>Interface</i>	<i>LIGO Subsystem</i>	<i>Characteristics</i>
PIT _{ASC} and YAW _{ASC}	ASC	Input Impedance: TBD Transfer Function: per sections 3.1.1.2.2 and 3.1.1.3.2 Connector: TBD
Fast Z input to Suspension Controller	LSC	Input Impedance: TBD ohms Transfer Function: per sections 3.1.1.2.3 and 3.1.1.2.3 Connector: TBD
UL, LL, UR, LR, S coils	Suspension system	#32 teflon coated wires provided by SUS soldered to kapton circuit board (provided by CDS) mounted on coil form.
UL, LL, UR, LR, S Photodiodes	Suspension system	#32 teflon coated wires provided by SUS soldered to kapton circuit board (provided by CDS) mounted on coil form.
UL, LL, UR, LR, S LEDs	Suspension system	#32 teflon coated wires provided by SUS soldered to kapton circuit board (provided by CDS) mounted on coil form.

3.1.3.1.3 Optical Interfaces

N/A

3.1.3.1.4 Stay Clear Zones**3.1.3.2 Interfaces external to LIGO subsystems****3.1.3.2.1 Mechanical Interfaces****3.1.3.2.2 Electrical Interfaces**

The following table summarizes the electrical interfaces to systems external to the LIGO detector.

Table 7: Electrical Interfaces to non-Detector Subsystems

<i>Interface</i>	<i>System</i>	<i>Characteristics</i>
Rack AC Power	AC Power System	Voltage: 115 VAC, +TBD, -TBD Current: 16 A max. Frequency: 60 Hz

3.1.3.2.3 Stay Clear Zones**3.1.4. Reliability**

The Mean Time Between Failure (MTBF) for components shall be greater than TBD.

3.1.5. Maintainability

The Mean Time To Repair (MTTR) for components shall be less than TBD

3.1.6. Environmental Conditions

The suspension controller electronics shall meet all performance requirements when exposed to all specified natural and induced environments.

3.1.6.1 Natural Environment**3.1.6.1.1 Temperature and Humidity****Table 8: Environmental Performance Characteristics**

<i>Operating</i>	<i>Non-operating (storage)</i>	<i>Transport</i>
+0 C to +50 C, 0-90%RH	-40 C to +70 C, 0-90% RH	-40 C to +70 C, 0-90% RH

3.1.6.1.2 Atmospheric Pressure

The suspension controller electronics design must accommodate atmospheric pressure changes from a maximum of 15.2 psia to a minimum of 14.2 psia.

3.1.6.1.3 Seismic Disturbance

N/A

3.1.6.2 Induced Environment**3.1.6.2.1 Electromagnetic Radiation**

The suspension controller electronics shall not degrade due to electromagnetic emissions as specified by IEEE C95.1-1991.

The suspension controller electronics shall not produce electromagnetic emissions greater than TBD.

3.1.6.2.2 Acoustic

Suspension controller electronics and associated control components shall be designed to produce the lowest levels of acoustic noise as possible and practical. In any event, acoustic noise levels greater than 35 dBA measured 1 foot from the device will not be produced.

3.1.6.2.3 Mechanical Vibration

Suspension controller electronics and associated control components shall not produce mechanical vibrations greater than TBD.

3.1.7. Transportability

All items shall be transportable by commercial carrier without degradation in performance. As necessary, provisions shall be made for measuring and controlling environmental conditions (temperature and accelerations) during transport and handling. Special shipping containers, shipping and handling mechanical restraints, and shock isolation shall be utilized to prevent damage. All containers shall be movable for forklift. All items over 100 lbs. which must be moved into place within LIGO buildings shall have appropriate lifting eyes and mechanical strength to be lifted by cranes.

3.2. Design and Construction**3.2.1. Materials and Processes**

Such items as units of measure to be used (English, Metric) should be listed and any other general items, such as standard polishing procedures and processes.

3.2.1.1 Finishes

- Ambient Environment: Surface-to-surface contact between dissimilar metals shall be controlled in accordance with the best available practices for corrosion prevention and control.
- *External surfaces: External surfaces requiring protection shall be painted purple or otherwise protected in a manner to be approved.*

3.2.1.2 Materials

All suspension controller electronics and equipment to be placed inside the LIGO vacuum chamber shall be in accordance with the LIGO list of approved vacuum materials. LIGO document number TBD.

3.2.1.3 Processes

All suspension controller electronics and equipment to be placed inside the LIGO vacuum chamber shall be cleaned in accordance with the LIGO vacuum cleaning standards. LIGO document number TBD.

3.2.2. Component Naming

All components shall identified using the LIGO Detector Naming Convention (document TBD). This shall include identification physically on components, in all drawings and in all related documentation.

3.2.3. Workmanship

All details of workmanship shall be of the highest grade appropriate to the methods and level of fabrication and consistent with the requirements specified herein. There shall be no evidence of poor workmanship that would make the components unsuitable for the purpose intended. All electronic circuits, modules and wiring shall be consistent with good engineering practice and fabricated to the best commercial standards.

3.2.4. Interchangeability

The suspension controller electronics and equipment shall be designed to maximize interchangeability and replaceability of mating components. Using the Line Replaceable Unit (LRU) concept, the designs shall be such that mating assemblies may be exchanged without selection for fit or performance and without modification to the section, the unit being replaced or adjacent equipment. Mature, performance proven, standard, commercially available equipment shall not be modified unless it impacts safety.

3.2.5. Safety

This item shall meet all applicable NSF and other Federal safety regulations, plus those applicable State, Local and LIGO safety requirements. A hazard/risk analysis shall be conducted in accordance with guidelines set forth in the LIGO Project System Safety Management Plan LIGO-M950046-F, section 3.3.2.

3.2.6. Human Engineering

The suspension controller electronics and associated components shall be designed and laid out in a manner consistent with applicable standard human engineering practices. Particular attention shall be paid to layouts of operator consoles/stations, work space and environmental conditions.

3.3. Documentation

3.3.1. Specifications

The following specifications shall be developed in the course of the design:

- TBD

3.3.2. Design Documents

The following design documents shall be provided:

- Suspension Controller Hardware Design and Description
- Suspension Controller Software Design Document

3.3.3. Engineering Drawings and Associated Lists

Engineering drawings, schematics, wire lists and cable routing lists shall be produced for the recycling electronics. To the greatest extent possible and practical, electronic copies shall be maintained and available on-line. All drawings shall be formatted according to LIGO standards.

3.3.4. Technical Manuals and Procedures

3.3.4.1 Procedures

Procedures shall be provided for, at minimum,

- *Initial installation and setup of equipment*
- *Normal operation of equipment*
- *Normal and/or preventative maintenance*
- *Troubleshooting guide for any anticipated potential malfunctions*

3.3.4.2 Manuals

The following manuals shall be provided:

- All manuals provided by commercial vendors for recycling components
- Manuals for all CDS produced electronics and software.

3.3.5. Documentation Numbering

All documents shall be numbered and identified in accordance with the LIGO documentation control numbering system LIGO document TBD

3.3.6. Test Plans and Procedures

All test plans and procedures shall be developed in accordance with the LIGO Test Plan Guidelines, LIGO document TBD.

3.4. Logistics

The design shall include a list of all recommended spare parts and special test equipment required.

3.5. Precedence

In the event of conflicts between this requirement document and other LIGO documents, this document shall take precedence.

3.6. Qualification

Qualification of various components and systems shall be in accordance with section 4 of this document.

4 QUALITY ASSURANCE PROVISIONS

4.1. General

4.1.1. Responsibility for Tests

The CDS group shall be responsible for performing all tests, including development of appropriate test plans and procedures.

4.1.2. Special Tests

4.1.2.1 Engineering Tests

TBD

4.1.2.2 Reliability Testing

Reliability evaluation/development tests shall be conducted on items with limited reliability history that will have a significant impact upon the operational availability of the system.

4.1.3. Configuration Management

Configuration control of specifications and designs shall be in accordance with the LIGO Detector Implementation Plan.

4.2. Quality conformance inspections

Design and performance requirements identified in this specification and referenced specifications shall be verified by inspection, analysis, demonstration, similarity, test or a combination thereof per the Verification Matrix, Appendix 1 (See example in Appendix). Verification method selection shall be specified by individual specifications, and documented by appropriate test and

evaluation plans and procedures. Verification of compliance to the requirements of this and subsequent specifications may be accomplished by the following methods or combination of methods:

4.2.1. Inspections

Inspection shall be used to determine conformity with requirements that are neither functional nor qualitative; for example, identification marks.

4.2.2. Analysis

Analysis may be used for determination of qualitative and quantitative properties and performance of an item by study, calculation and modeling.

4.2.3. Demonstration

Demonstration may be used for determination of qualitative properties and performance of an item and is accomplished by observation. Verification of an item by this method would be accomplished by using the item for the designated design purpose and would require no special test for final proof of performance.

4.2.4. Similarity

Similarity analysis may be used in lieu of tests when a determination can be made that an item is similar or identical in design to another item that has been previously certified to equivalent or more stringent criteria. Qualification by similarity is subject to Detector management approval.

4.2.5. Test

Test may be used for the determination of quantitative properties and performance of an item by technical means, such as, the use of external resources, such as voltmeters, recorders, and any test equipment necessary for measuring performance. Test equipment used shall be calibrated to the manufacture's specifications and shall have a calibration sticker showing the current calibration status.

5 PREPARATION FOR DELIVERY

Packaging and marking of equipment for delivery shall be in accordance with the Packaging and Marking procedures specified herein.

5.1. Preparation

Equipment shall be appropriately prepared. For example, vacuum components shall be prepared to prevent contamination.

5.2. Packaging

Procedures for packaging shall ensure cleaning, drying, and preservation methods adequate to prevent deterioration, appropriate protective wrapping, adequate package cushioning, and proper containers. Proper protection shall be provided for shipping loads and environmental stress during transportation, hauling and storage.

5.3. Marking

Appropriate identification of the product, both on packages and shipping containers; all markings necessary for delivery and for storage, if applicable; all markings required by regulations, statutes, and common carriers; and all markings necessary for safety and safe delivery shall be provided.

6 NOTES

N/A

APPENDIX 1 QUALITY CONFORMANCE INSPECTIONS

The following table shows the methods of testing that will be used for verification of quality conformance.

Table 9: Quality Conformance Inspections

<i>Paragraph</i>	<i>Title</i>	<i>I</i>	<i>A</i>	<i>D</i>	<i>S</i>	<i>T</i>
3.1.1.1.1	LED Drive Current			X		X
3.1.1.1.2	Photodiode Current to Voltage Conversion			X		X
3.1.1.2.1	LOS Local Damping Transfer Function			X		X
3.1.1.2.2	LOS ASC Input to Actuator Coil Transfer Function			X		X
3.1.1.2.3	LOS LSC Input to Actuator Coil Transfer Function			X		X
3.1.1.2.4	LOS Dynamic Range and Input and Output Noise			X		X
3.1.1.3.1	SOS Local Damping Transfer Function			X		X

Table 9: Quality Conformance Inspections

<i>Paragraph</i>	<i>Title</i>	<i>I</i>	<i>A</i>	<i>D</i>	<i>S</i>	<i>T</i>
3.1.1.3.2	SOS ASC Input to Actuator Coil Transfer Function			X		X
3.1.1.3.3	SOS LSC Input to Actuator Coil Transfer Function			X		X
3.1.1.3.4	SOS Dynamic Range and Input and Output Noise			X		X
3.1.1.4	Basis Transformations (Small and Large Optic Suspension)			X		X
3.1.1.6	Test Inputs, Outputs and Functions			X		X