

Squeezed Light Enhanced Michelson-Interferometer

Roman Schnabel, S. Chelkowski, J. Harms,
A. Franzen, H. Vahlbruch, K. Danzmann

Universität Hannover, Albert-Einstein-Institut



Contents

I Non-classical interferometry at low laser power

- Squeezed-input power-recycled Michelson interferometer (MI) beyond the shot-noise limit (SNL),
- Squeezed-input dual-recycled Michelson interferometer,

II Non-classical interferometry at high laser power

- Squeezed-input Fabry-Perot Michelson interferometer beyond the standard quantum limit (SQL),
- Optical noise correlations in a dual-recycled Michelson interferometer at high laser power (GEO 600).

Quantum Noise

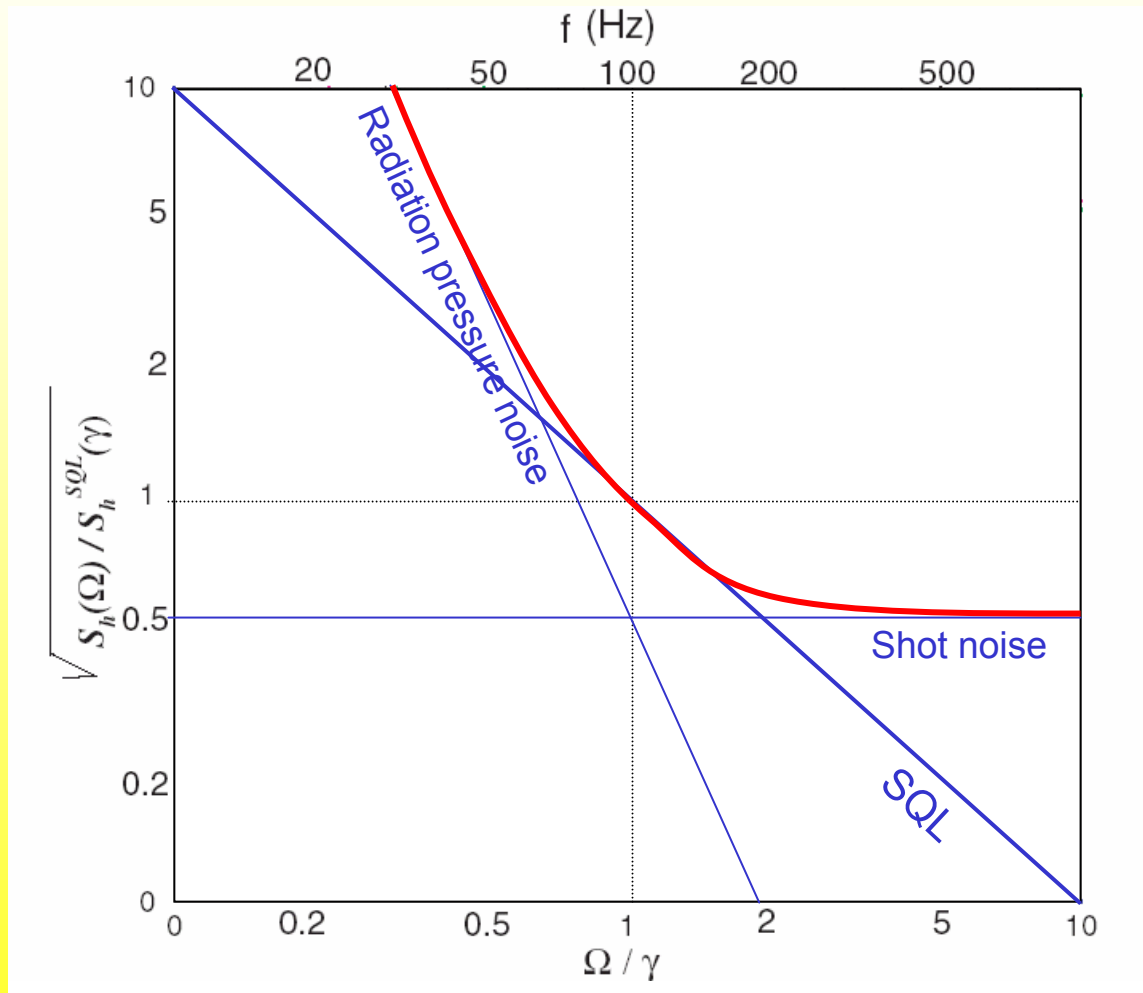

Power-recycled MI beyond the SNL

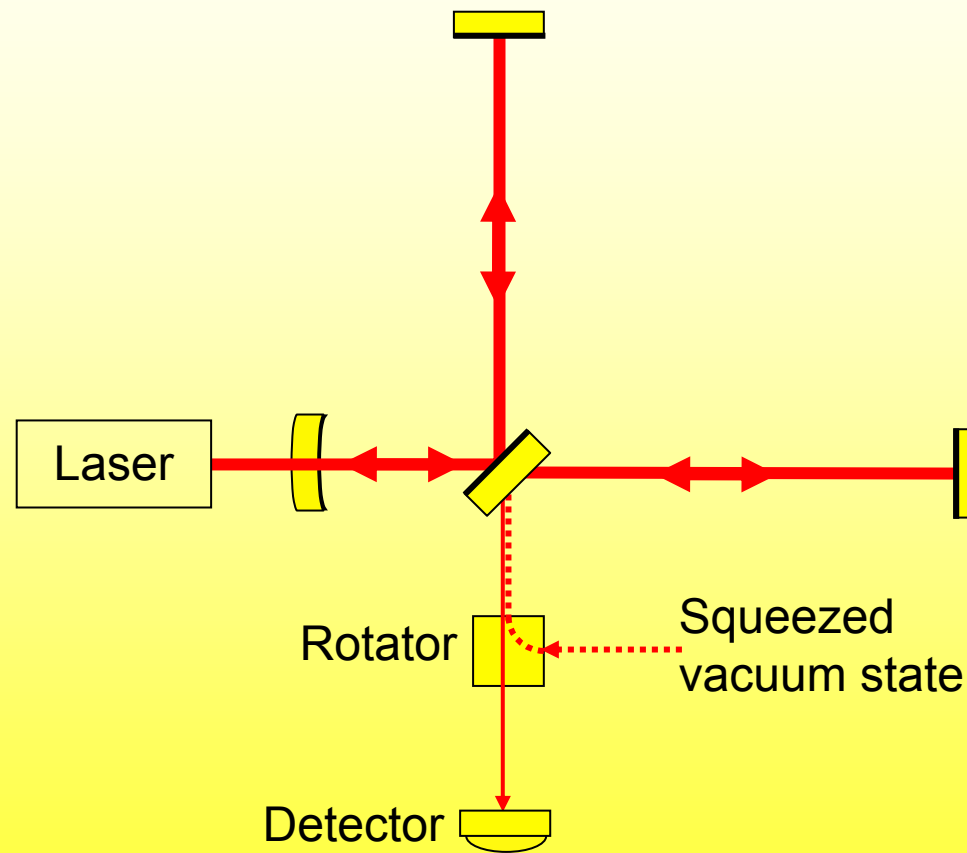

Power-recycled MI beyond the SNL

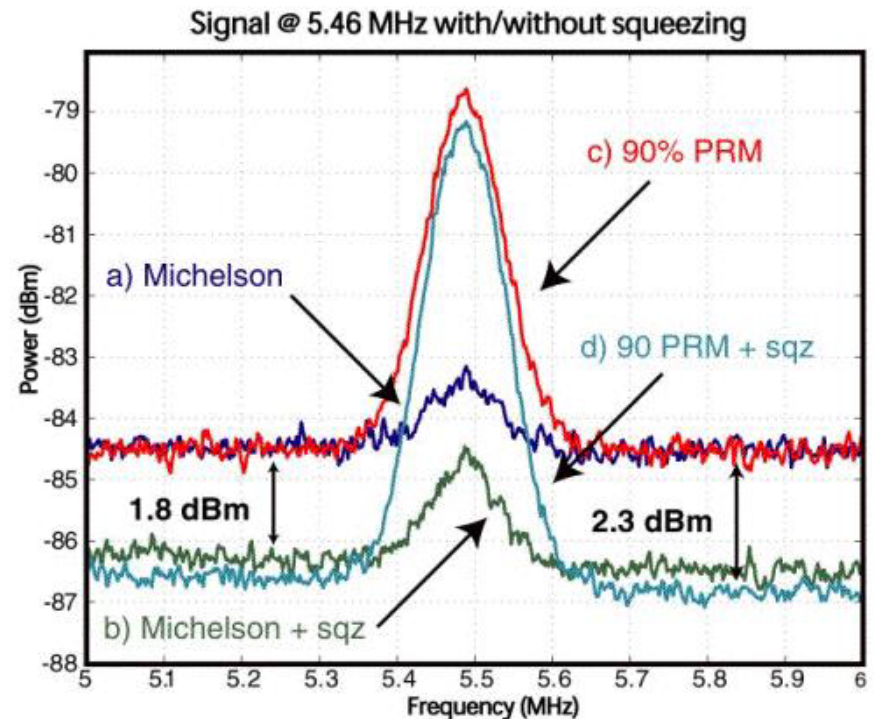
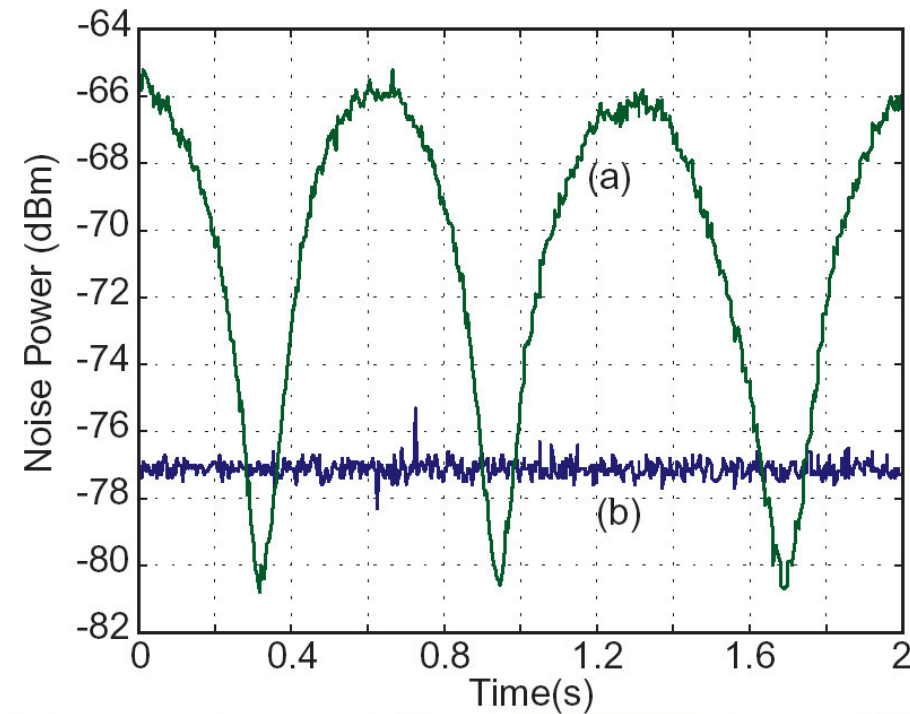

K. McKenzie, D. A. Shaddock, D. E. McClelland, B. C. Buchler and P. K. Lam, Phys. Rev. Lett. 88, 231102 (2002)

Power-recycled MI beyond the SNL

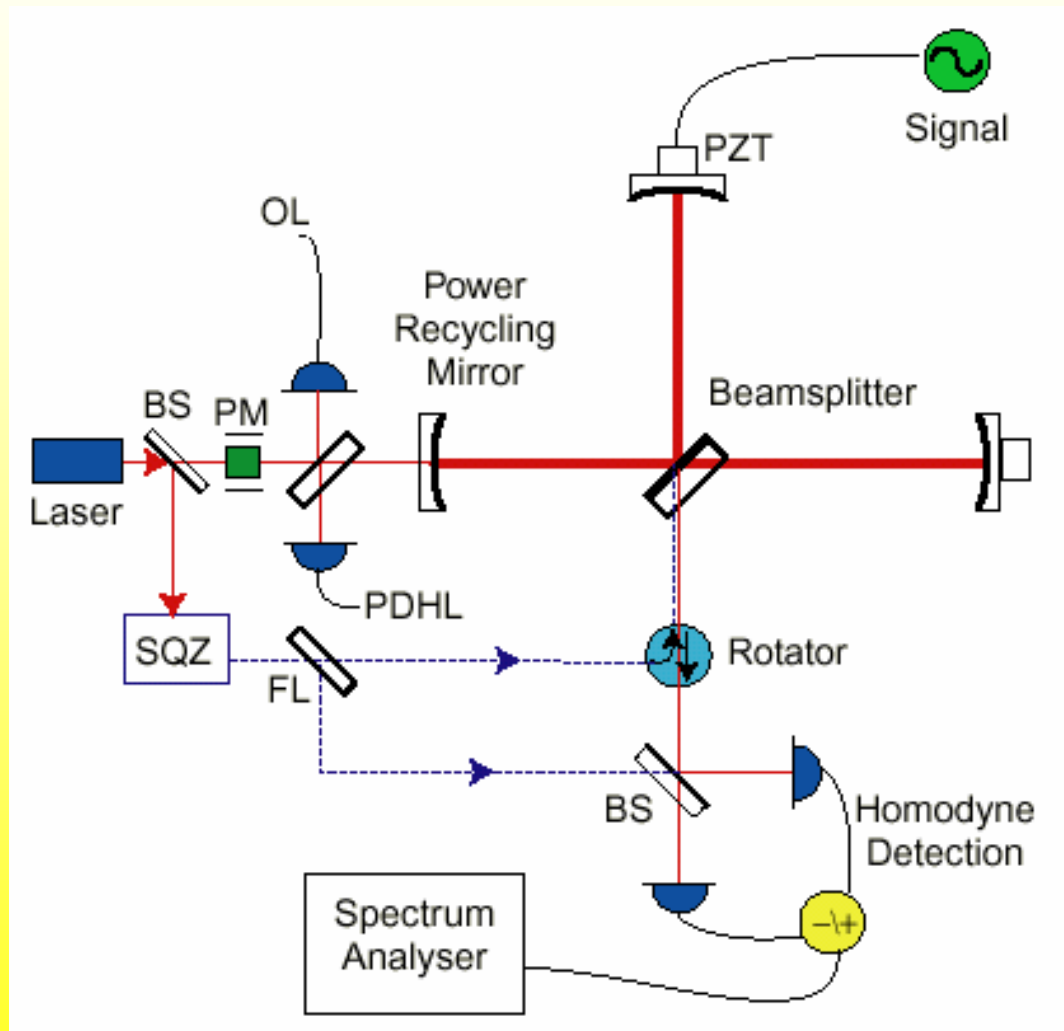

K. McKenzie *et al.*,
 Phys. Rev. Lett. 88,
 231102 (2002)

Advanced Michelson Interferometer

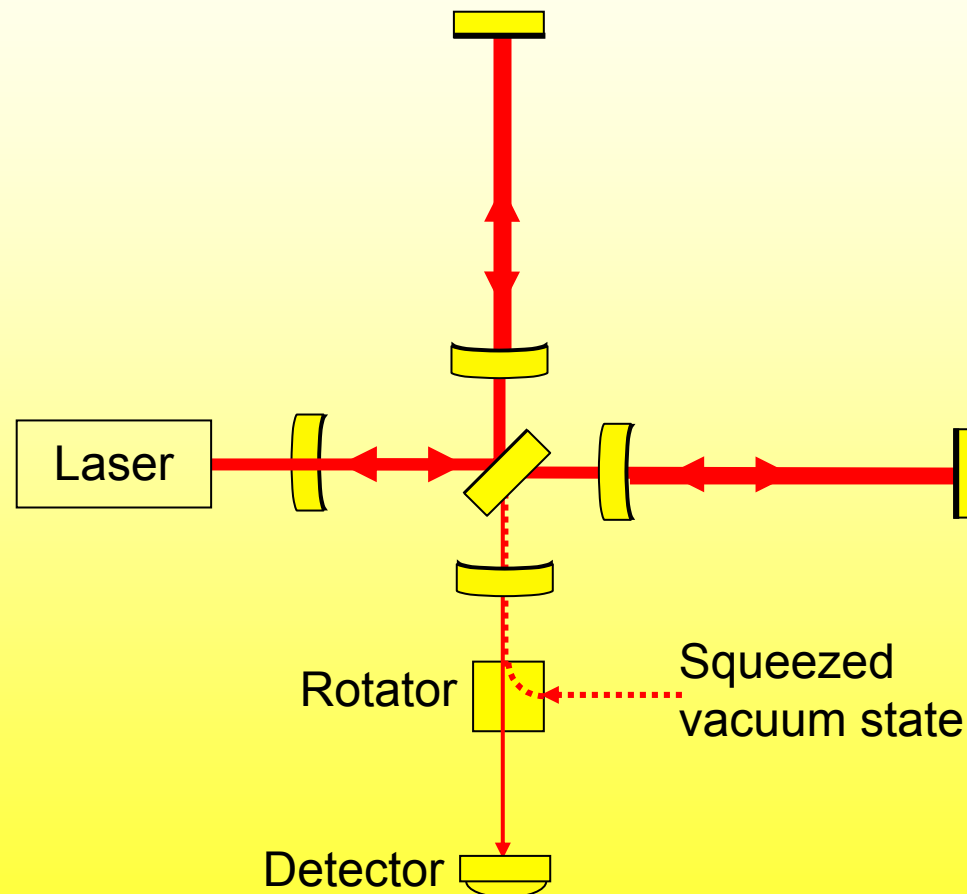

MI with Arm Cavities beyond the SQL

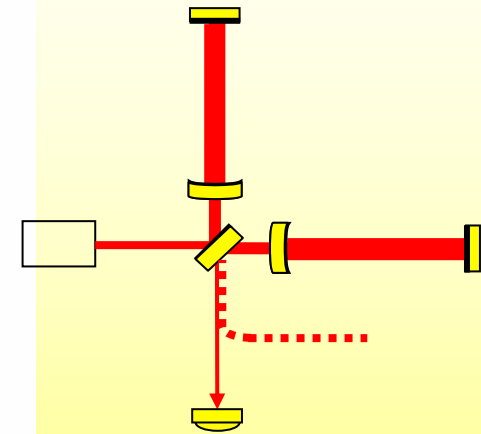
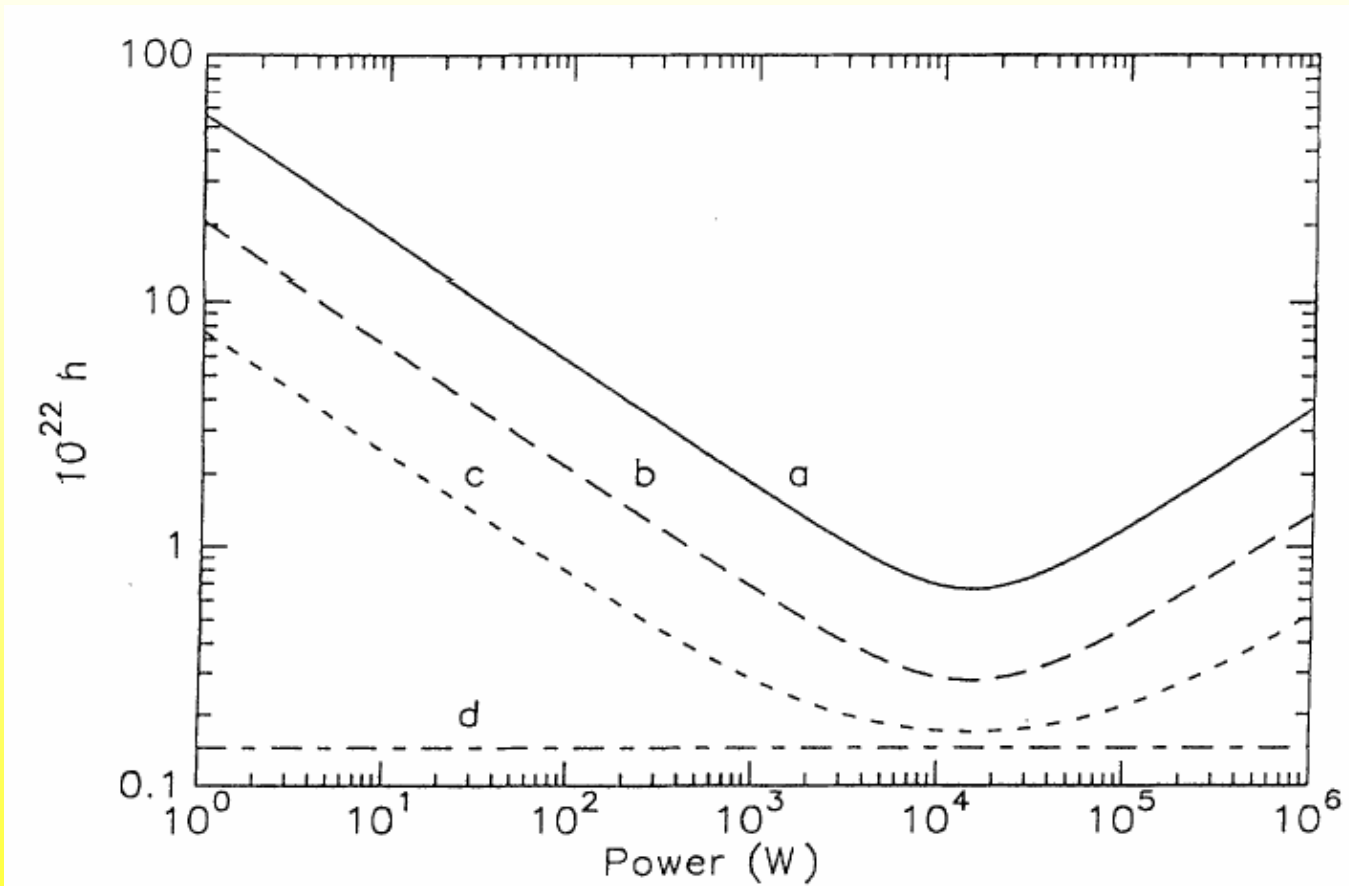

A. F. Pace *et al.*, Phys. Rev. A 47, 3173 (1993),
 H. J. Kimble *et al.*, Phys. Rev. D 65, 022002 (2001)

Dual-recycled MI beyond the SNL

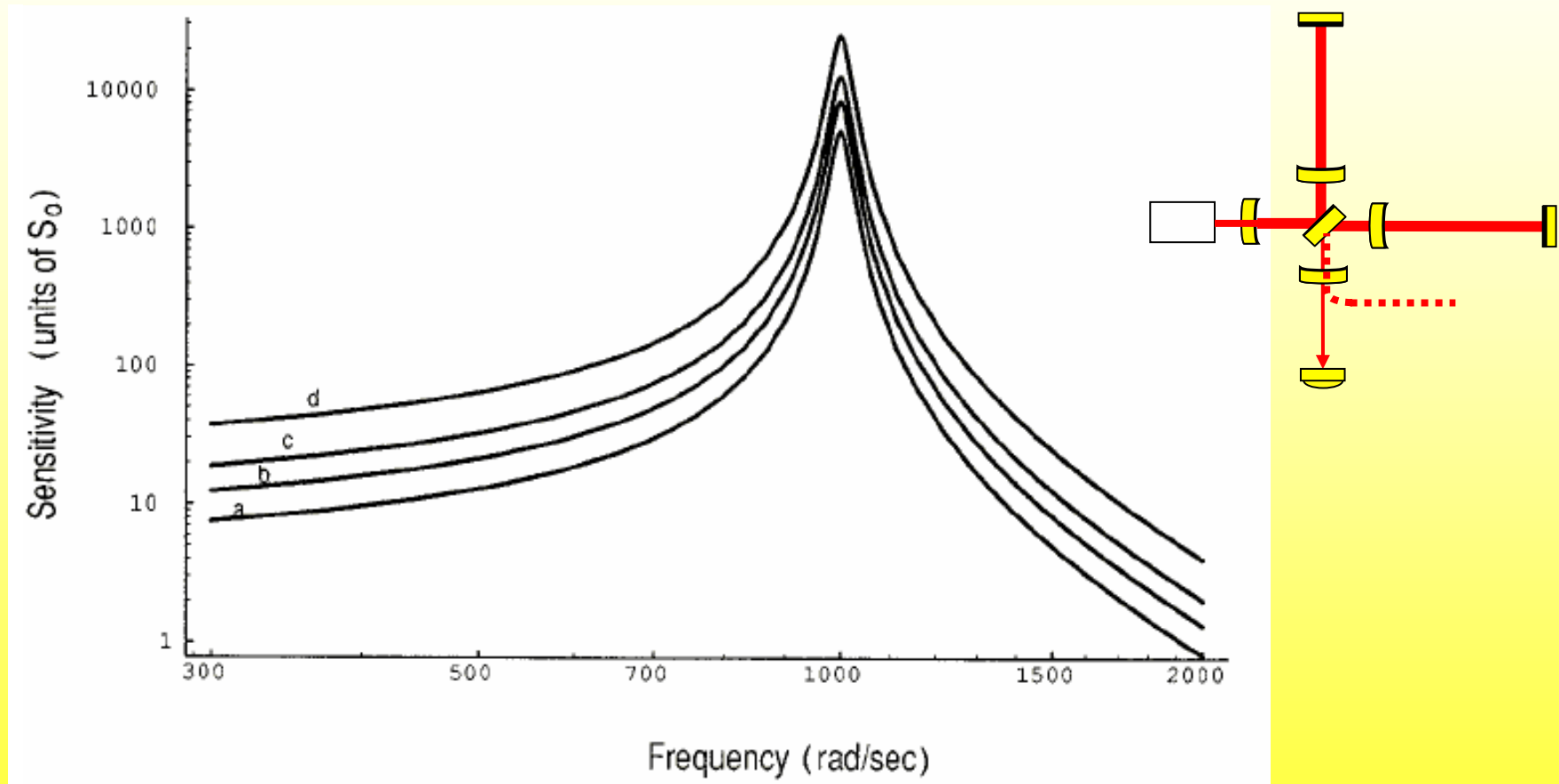

V. Chickarmane and S. V. Dhurandhar, Phys. Rev. A, 54, 786 (1996)

Experimental Prospects

- Realization of frequency dependant squeezing,
- Realization of low frequency squeezing,
- Realization of low intensity proposals in table-top experiments (broadband and narrowband signal recycling MI).

MI with Dual Recycling, no SQZ input

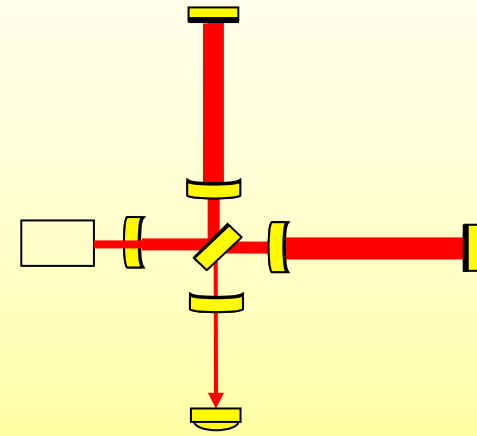
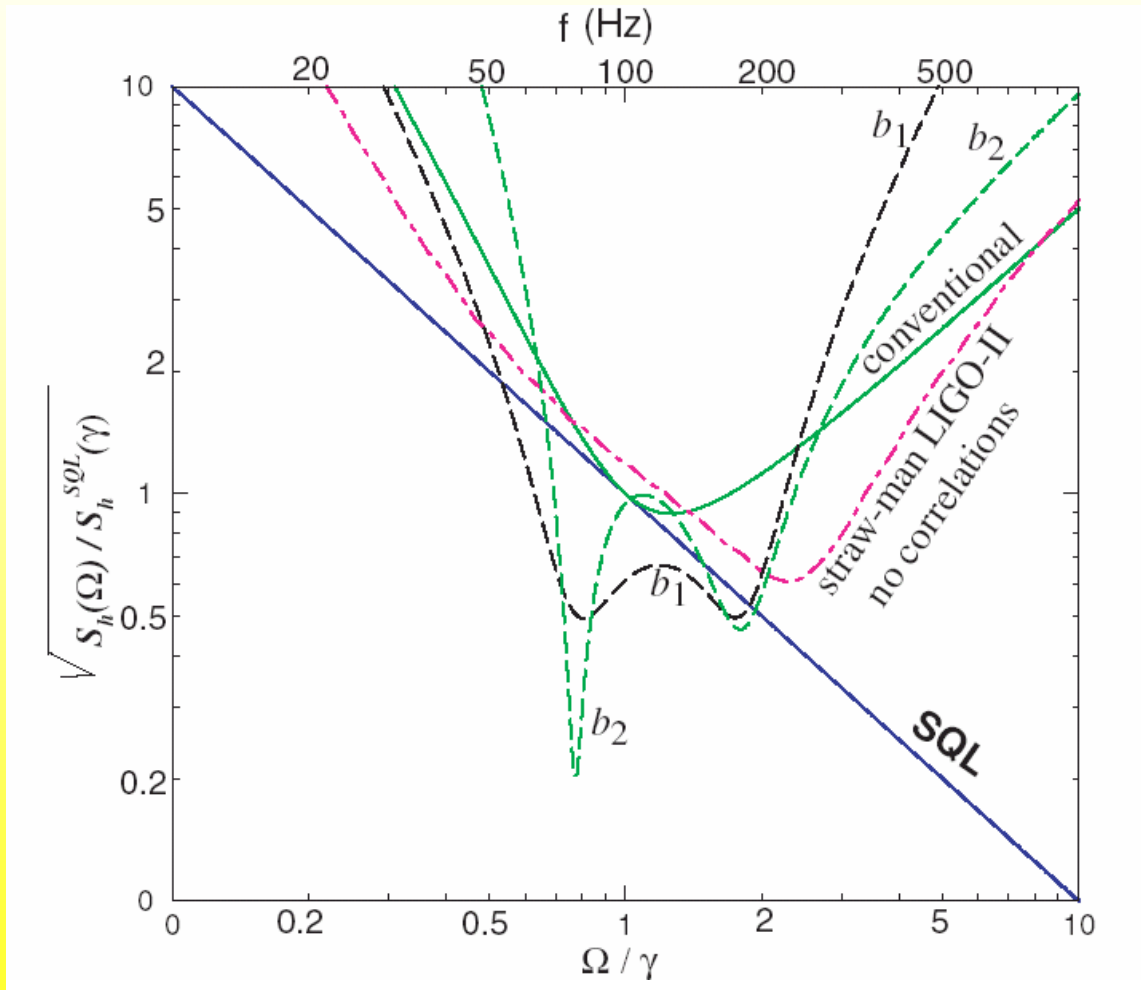

A. Buonanno and Y. Chen,
Class. Quantum Grav. 18,
L95 (2001)

GEO600 Dual Recycling, no SQZ input

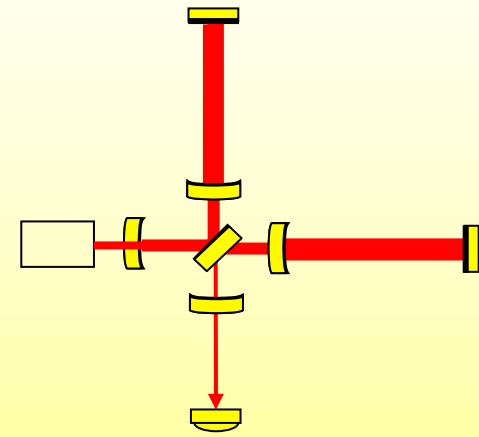
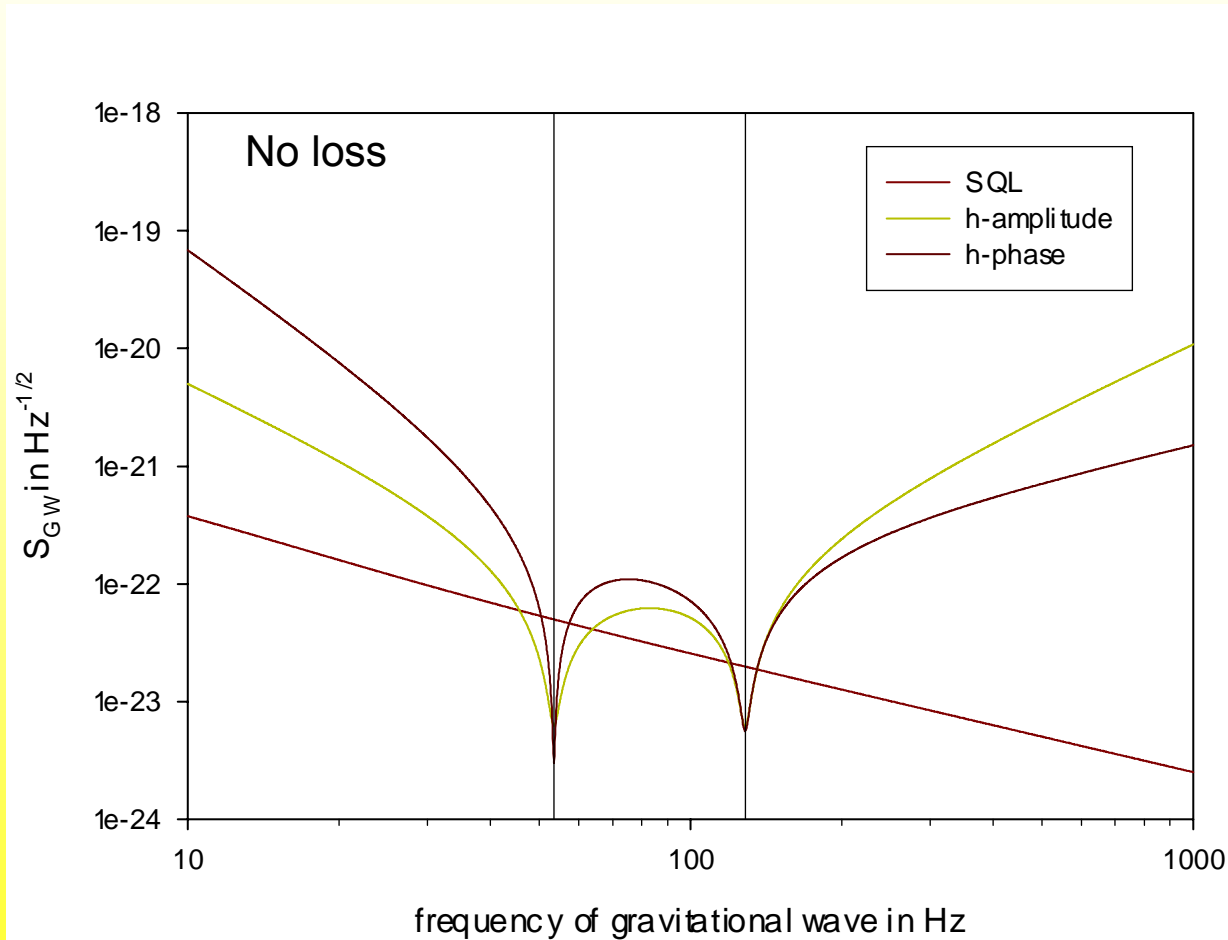

J. Harms,
Diploma Thesis (2002)

GEO600 Dual Recycling, no SQZ input

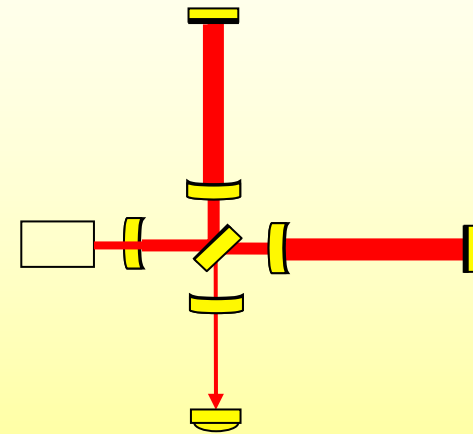
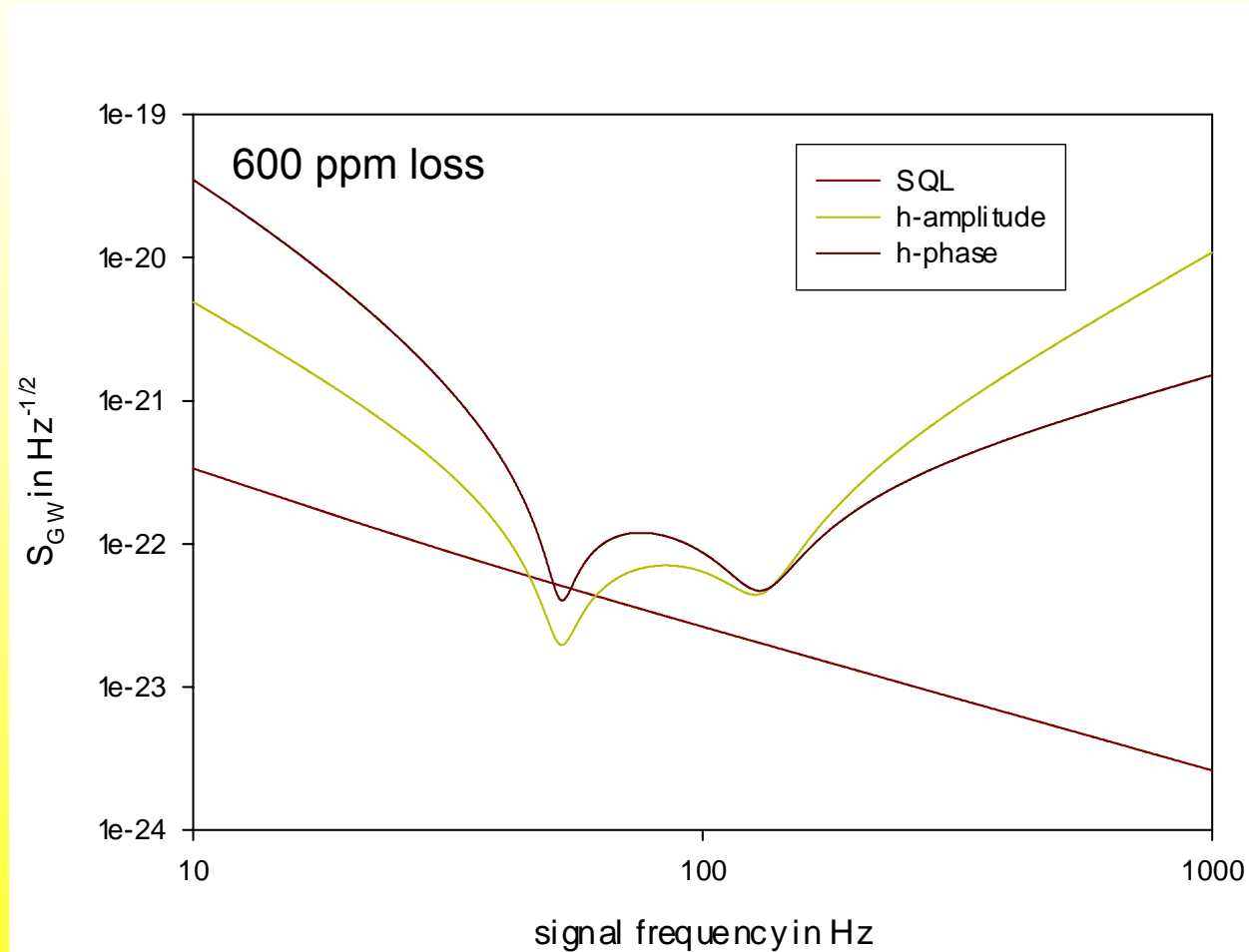

J. Harms,
Diploma Thesis (2002)

GEO600 Dual Recycling, no SQZ input

Squeezing parameter r

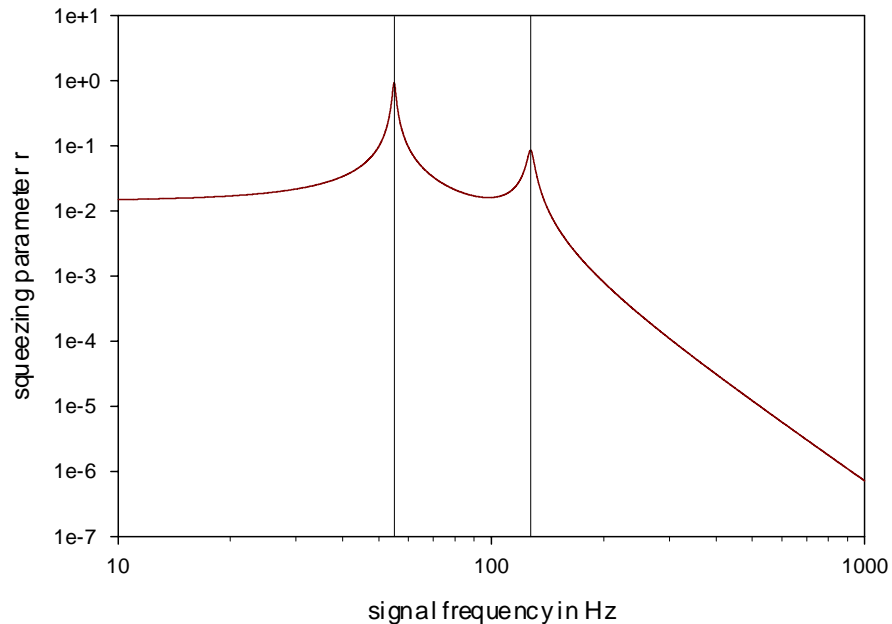

Heisenberg uncertainty product

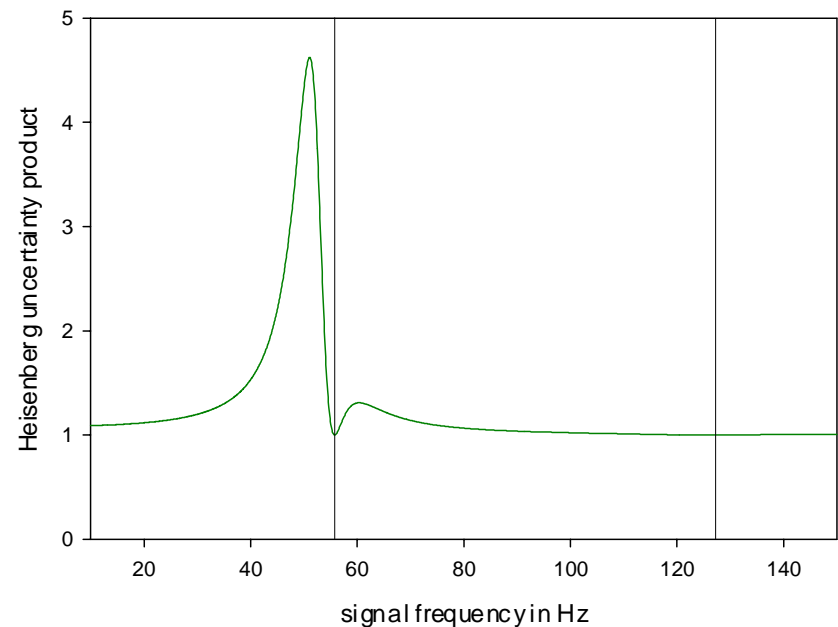

J. Harms, Diploma Thesis (2002)