



Physics of Interferometric Gravitational Wave Detectors



*Biplab Bhawal - LIGO Laboratory,
California Institute of Technology, USA*

International Conference on Gravitation and Cosmology
Kochi, India Jan'2004

LIGO-040017-00-E

Interferometer as Gravitational wave detector

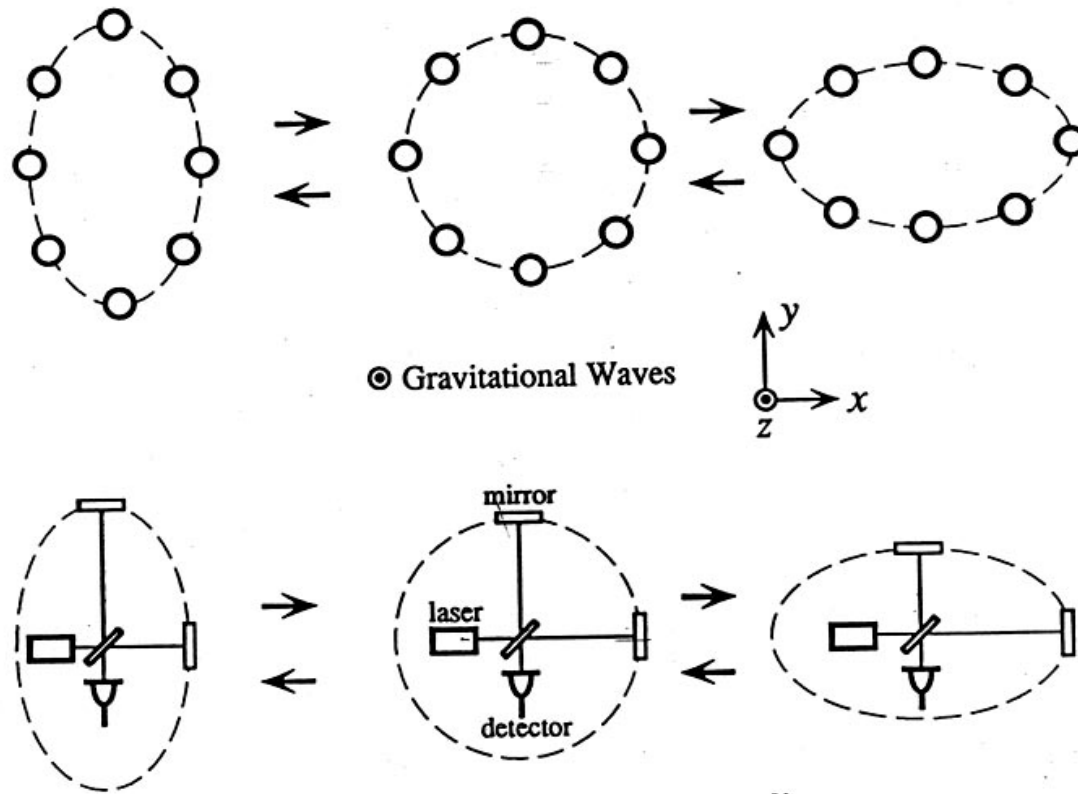

Gravitational Waves

the effect

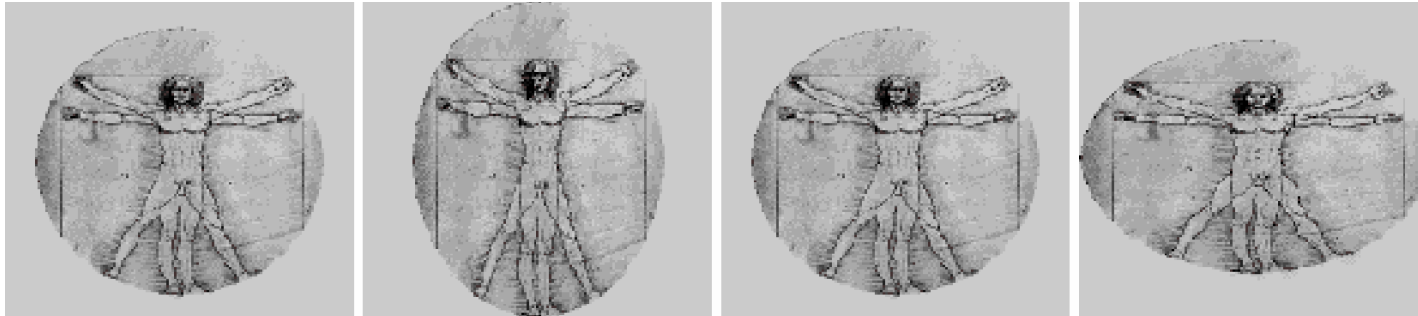

Leonardo da Vinci's Vitruvian man

stretch and squash in perpendicular directions at the frequency of the gravitational waves

The effect is greatly exaggerated!!

If the man were 4.5 light years high, he would grow by only a 'hairs width' LIGO (4 km), stretch (squash) = 10^{-18} m will be detected at frequencies of 10 Hz to 10^4 Hz. It can detect waves from a distance of $60 \cdot 10^6$ light years

How Small is 10^{-18} Meter?

		<i>One meter</i>
$\div 10,000$		<i>Human hair, about 100 microns</i>
$\div 100$		<i>Wavelength of light, about 1 micron</i>
$\div 10,000$		<i>Atomic diameter, 10^{-10} meter</i>
$\div 100,000$		<i>Nuclear diameter, 10^{-15} meter</i>
$\div 1,000$		<i>LIGO sensitivity, 10^{-18} meter</i>



The Laboratory Sites

Laser Interferometer Gravitational-wave Observatory (LIGO)

Hanford
Observatory

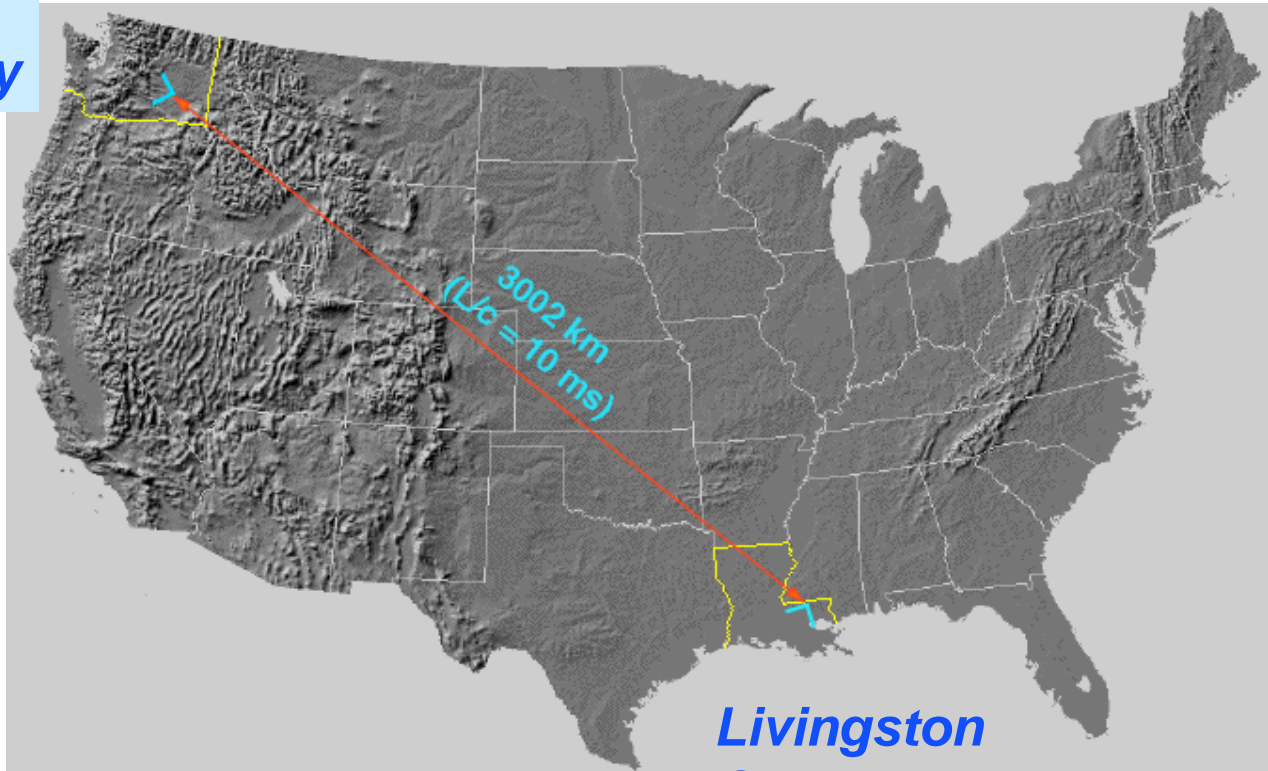

Livingston
Observatory



LIGO

Livingston Observatory





LIGO

Hanford Observatory



LIGO-G040017-00-E

ICGC-2004, Kochi, India



Outline of Talk

- Introduction to LIGO I configuration
- Length Control & Lock acquisition
- Misalignment & Wave-Front sensor
- Thermal Lensing & compensation
- Advanced LIGO features



LIGO Interferometer Optical Scheme

- Michelson interferometer with Fabry-Perot arm cavities
- Arm cavity storage time
 $\tau \sim 1/2\pi f_{GW}$
- Recycling mirror enhances effective power by $\sim 50x$

Price to pay:

- 5 mirror separations to be integer half-wavelength multiples (within $\sim 10^{-13}$ m)
- all mirror normals to be precisely aligned (within $\sim 10^{-8}$ rad)
- dilemma: mirrors "free" inertially at GW frequencies, "static" in an RMS sense

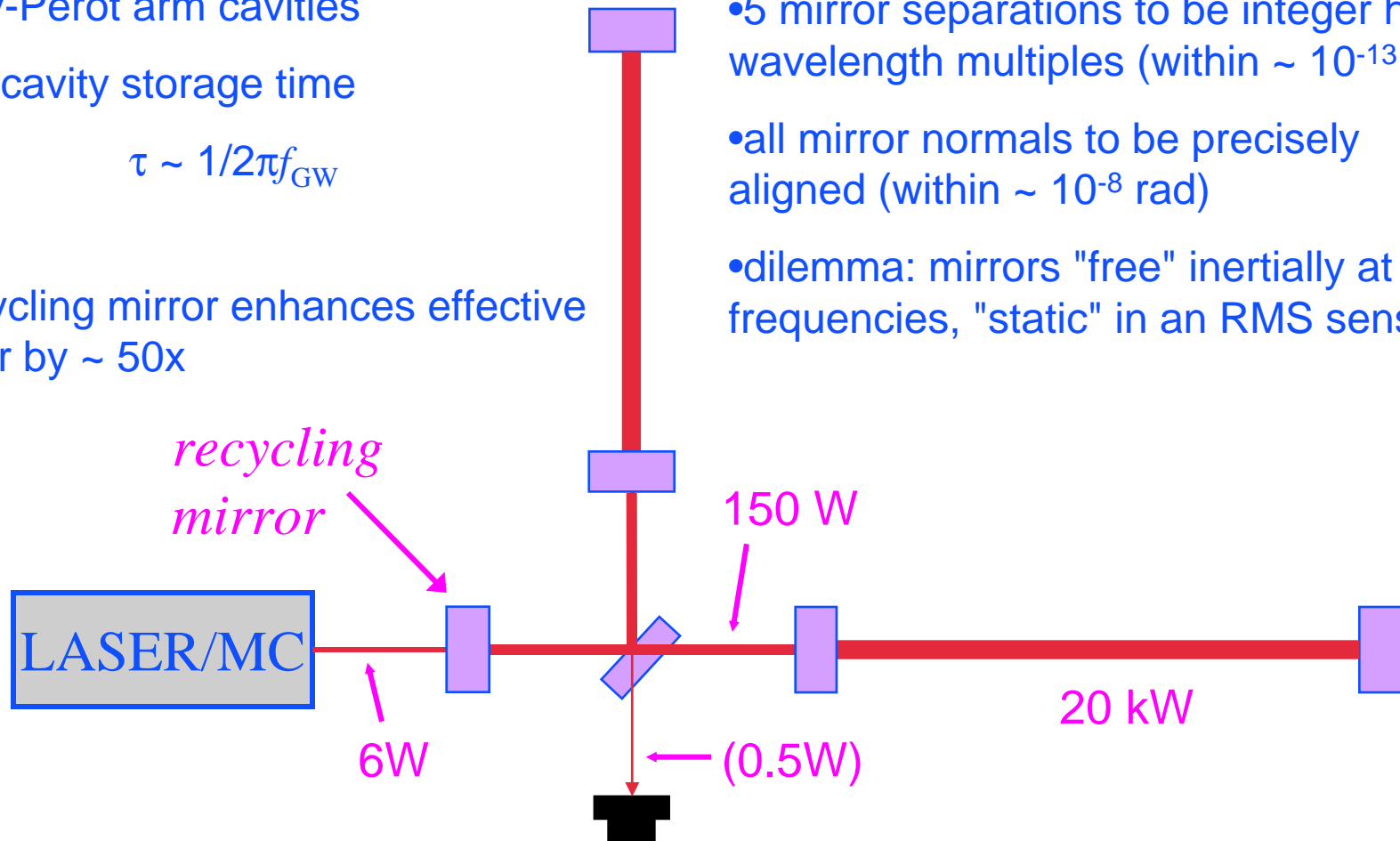

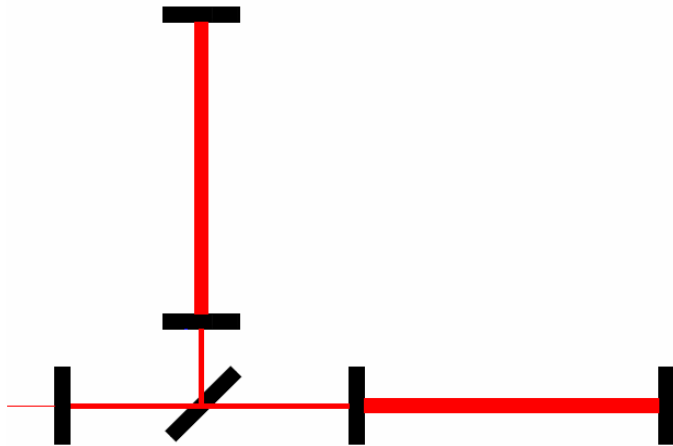

The system is

- Dynamic
- Coupled
- Nonlinear

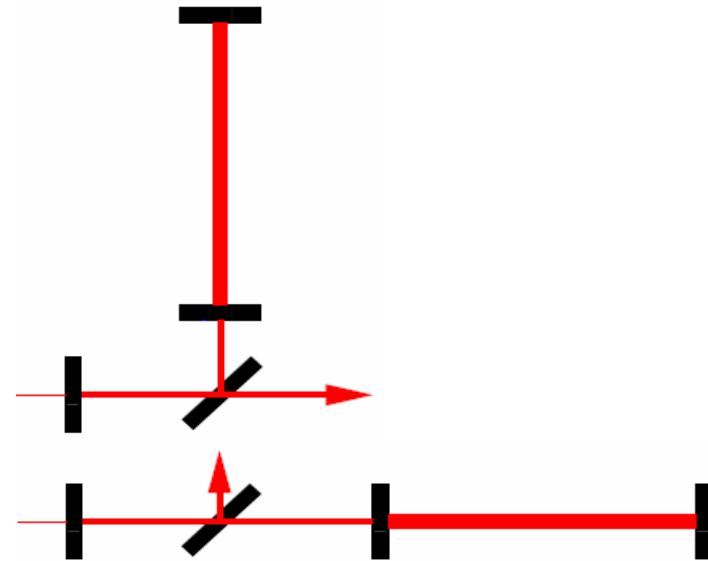

LIGO configuration:

Equivalent to 2 coupled cavities which themselves are coupled together

Initial LIGO Sensitivity Goal

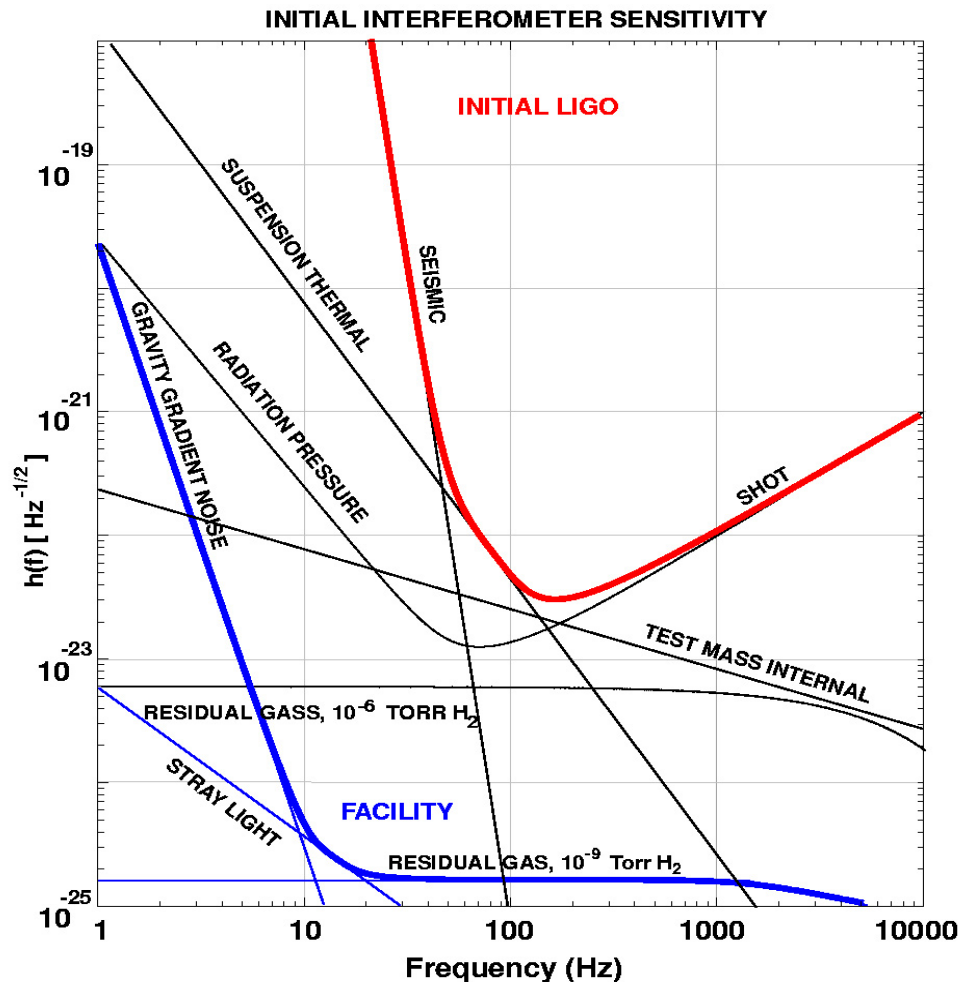

- Strain sensitivity
 - < $3 \times 10^{-23} \text{ 1/Hz}^{1/2}$
 - at 200 Hz
- Displacement Noise
 - » Seismic motion
 - » Thermal Noise
 - » Radiation Pressure
- Sensing Noise
 - » Photon Shot Noise
 - » Residual Gas

Seismic isolation stacks

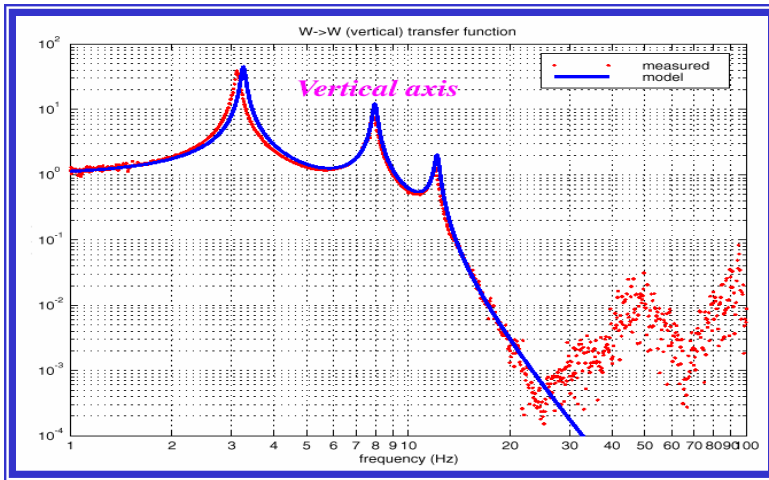
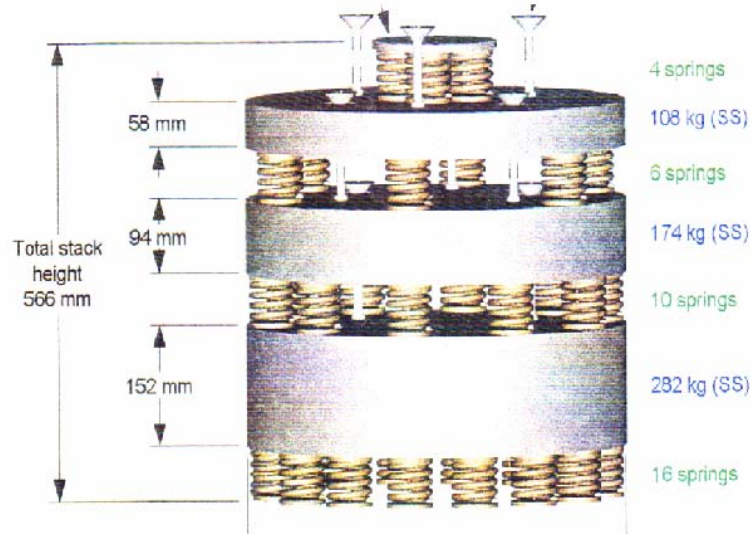

LIGO-G040017-00-E



ICGC-2004, Kochi, India

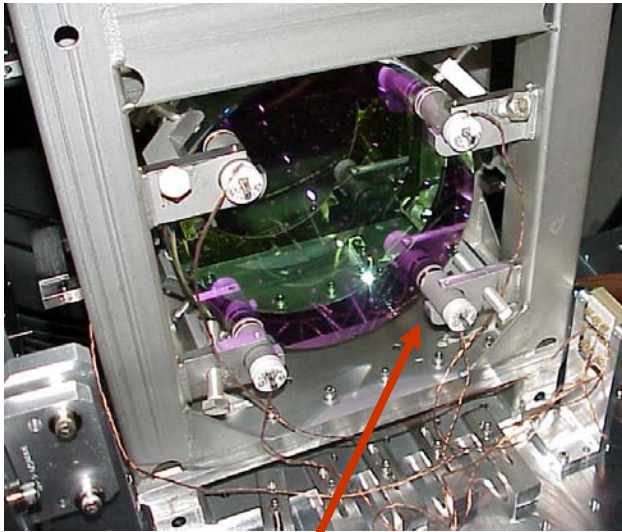

- Optics suspended as simple pendulums
- Local sensors/actuators for damping and control
- Coils push/pull on tiny magnets glued to optics
- Earthquake stops to prevent break-off of tiny magnets

LIGO-G040017-00-E



ICGC-2004, Kochi, India

Suspended mass with local control

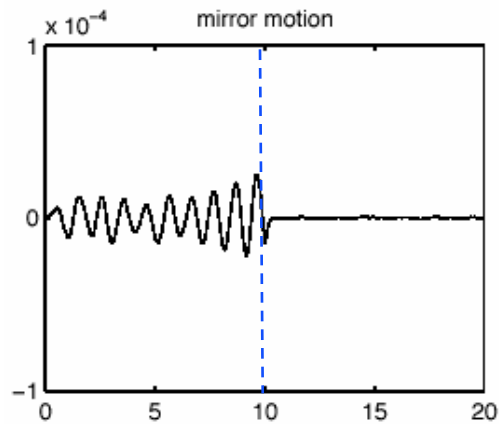
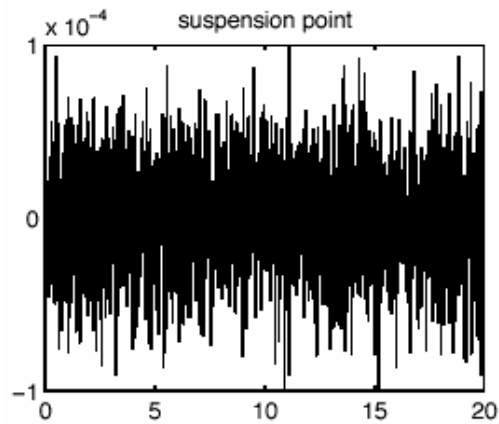

Control on at 10

Suspension point



Pendulum res. at 1Hz

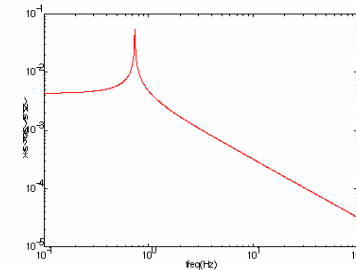

Force



Mass position

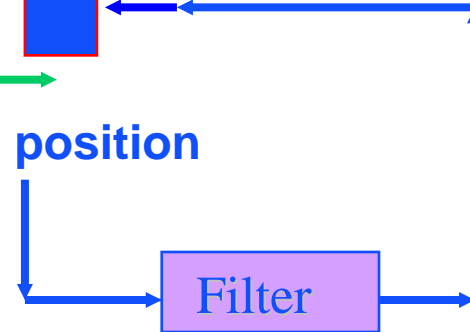

- Global Length Sensing and Control

- » Reflection locking technique length and frequency sensing
- » Control 4 longitudinal degrees of freedom and laser frequency
- » Requirements:
 - Differential arm length $< 10^{-13}$ m rms
 - Frequency noise $< 3 \times 10^{-7}$ Hz/Hz^{1/2} at 100 Hz
 - Controller noise for diff. arm length $< 10^{-20}$ m/ Hz^{1/2} at 150 Hz

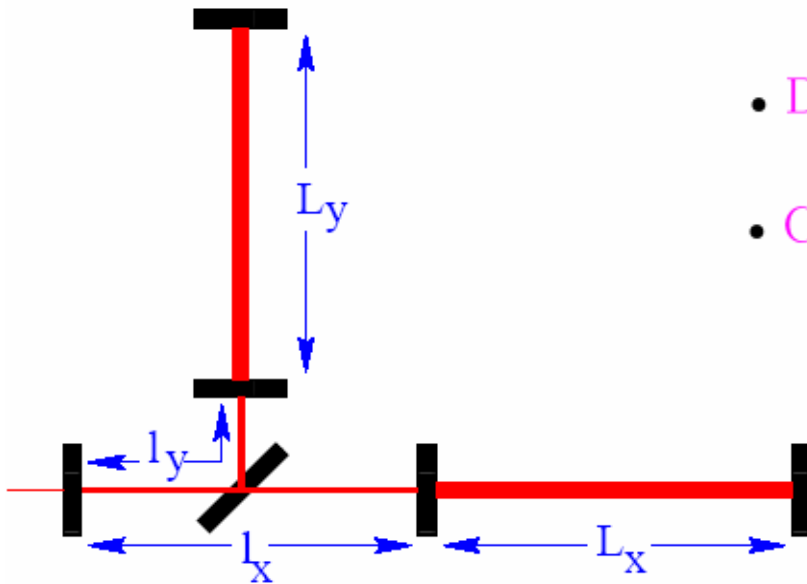

- Differential Modes: $(L_x - L_y)/2$, $(l_x - l_y)/2$
- Common Modes: $(L_x + L_y)/2$, $(l_x + l_y)/2$

Phase modulation

- Phase Modulation

$$\exp(i\omega_c t) \times \exp[i\epsilon_m \sin(\omega_m t)]$$

- Series Expansion

$$e^{i\omega_c t} \times [J_0(\epsilon_m) + J_1(\epsilon_m) e^{i\omega_m t} + J_{-1}(\epsilon_m) e^{-i\omega_m t} + \dots]$$

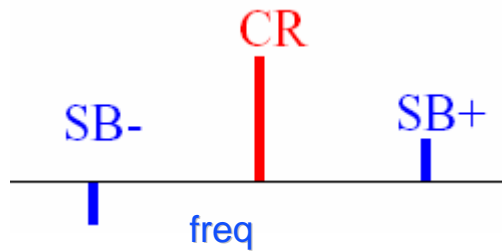

$$\simeq e^{i\omega_c t} \times \left[1 + \frac{\epsilon_m}{2} e^{+i\omega_m t} - \frac{\epsilon_m}{2} e^{-i\omega_m t} \right]$$

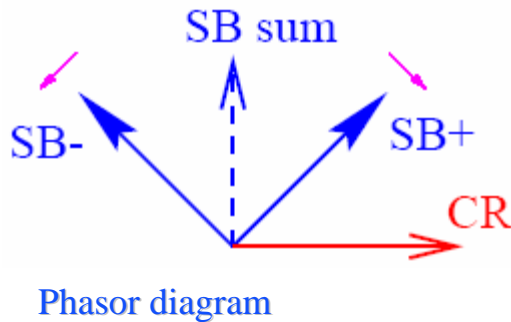

$$\simeq e^{i\omega_c t} \times [1 + i\epsilon_m \sin(\omega_m t)]$$

Fabry-Perot Cavity dynamics

microscopic length offset: $x = n\lambda - L$

phase: $\phi = 4\pi x / \lambda$

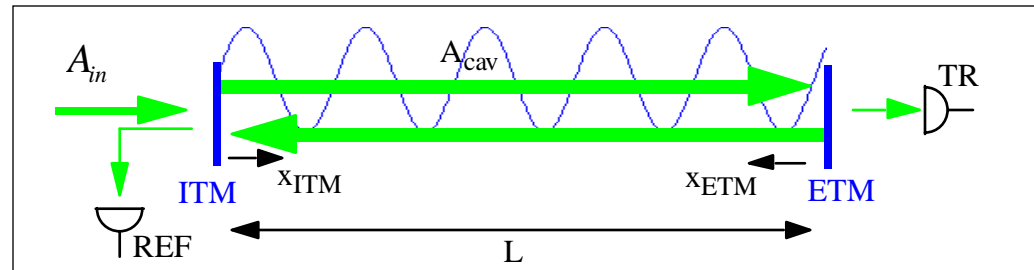
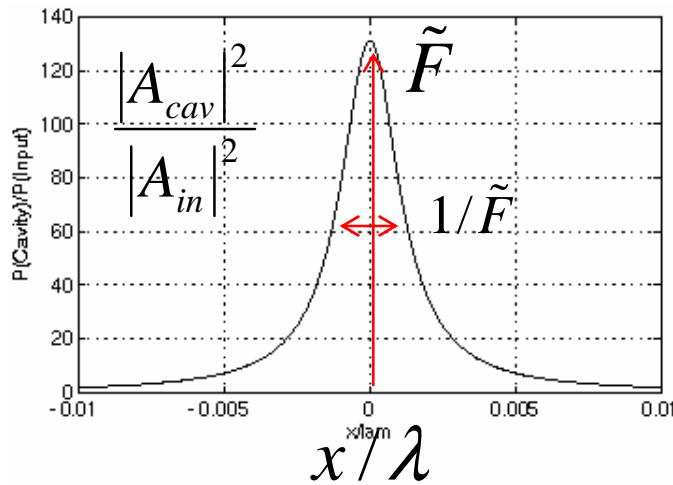

$$A_{cav} = A_{in} \frac{t_{ITM}}{1 - r_{ITM} r_{ETM} e^{i\phi}} \quad \tilde{F} = \left(\frac{t_{ITM}}{1 - r_{ITM} r_{ETM}} \right)^2 \approx \frac{4}{t_{ITM}^2}$$

$$\approx A_{in} \sqrt{\tilde{F}} \left(1 + i2\pi \cdot \frac{x}{\lambda/\tilde{F}} \right)$$

$$x \ll \lambda$$

$$A_{ref} = r_{ITM} - t_{ITM} r_{ETM} e^{i\phi} A_{cav}$$

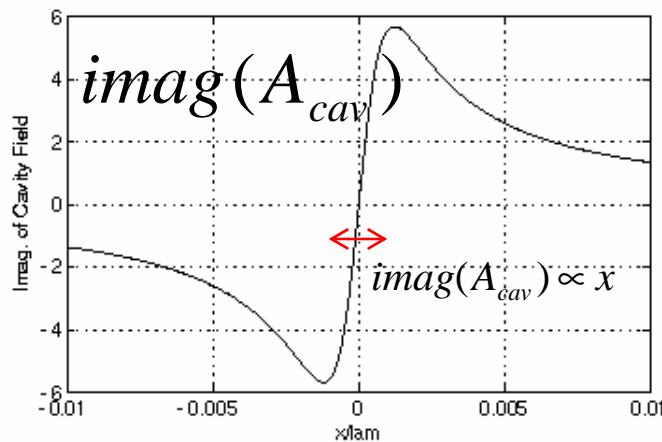

$$t_{ITM}^2 = 0.03$$

$$t_{ETM}^2 = 10e^{-6}$$

$$\tilde{F} = 130$$

Signal from Power? -No

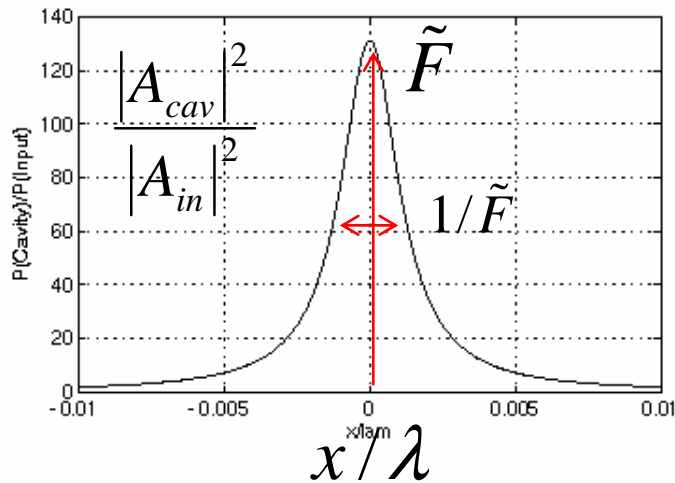

$$A_{cav} = A_{in} \frac{t_{ITM}}{1 - r_{ITM} r_{ETM} e^{i\phi}}$$

$$\approx A_{in} \sqrt{\tilde{F}} \left(1 + i2\pi \cdot \frac{x}{\lambda/\tilde{F}} \right)$$

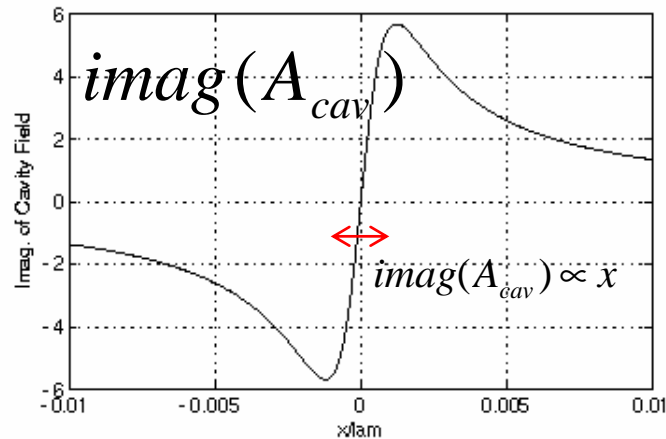

$$P_{cav} = A_{in}^2 F \times \left[1 - 4\pi^2 \left(\frac{x}{\lambda/F} \right)^2 \right]$$

$$\lambda/F \simeq 10^{-8} \text{ meter}$$

Pound-Drever Signal

Power: $|CR + SB^+ + SB^-|^2$

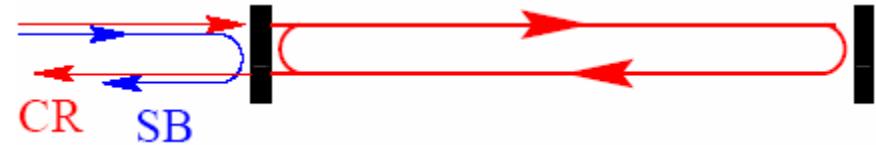

Signal (beating between CR and SBs):

$$2 \times \text{Real} (CR^* \times [SB^+ + SB^-])$$

$$= 2 \times \text{Real} (CR^* \times i\varepsilon_m \sin(\omega_m t))$$

When CR has got a phase, ϕ due to length change:

$$\propto \text{Real} ((1 + i\phi) \times i\varepsilon_m \sin(\omega_m t))$$

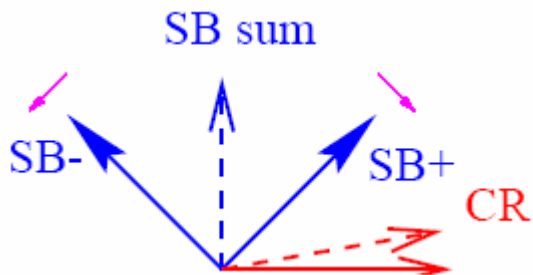

Phasor diagram

$$\propto \phi \cdot \varepsilon_m \sin(\omega_m t)$$

signal: $\propto \phi \cdot \epsilon_m \sin(\omega_m t)$

Demodulated signal:

$$\phi \cdot \epsilon_m \sin^2(\omega_m t) = \frac{1}{2} \phi \cdot \epsilon_m [1 - \cos(2\omega_m t)]$$

Pass it thru low-pass filter:

$$\propto \phi \cdot \epsilon_m$$



Interferometer Operating Condition

Carrier resonant in all cavities
 Ideal: No light in anti-sym port (Dark)

Differential length change ->
 CR leaks thru anti-sym port
 Beats with SB present there -> Signal

SBs resonant only in recycling cavity

Difference in rec cav lengths allows SBs to leak thru anti-sym port

$$P_{SB}(dark) = [\omega(\ell_x - \ell_y)/c]^2$$

SB efficiency 100% when

$$P_{SB}(dark) = P_{SB}(input)$$

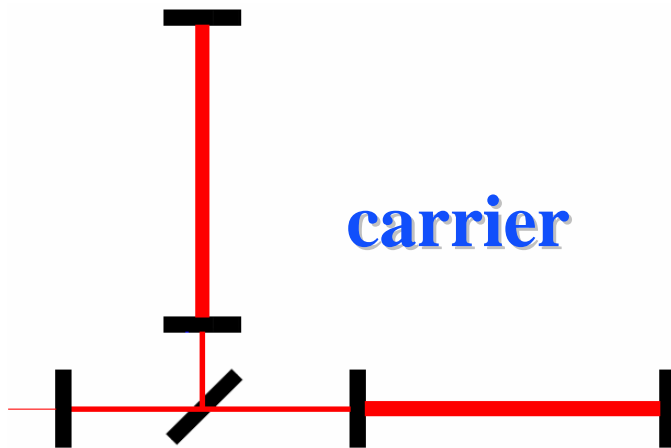

Dark port

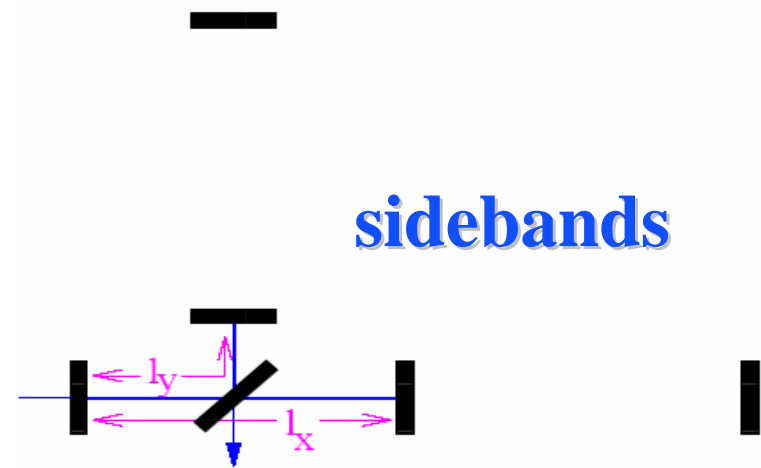



LIGO End to End (E2E) Simulation

Motivation for time-domain simulation:

- Assist detector design, commissioning, and data analysis
- To understand a complex system
 - » **complex hardware** : pre-stabilized laser, input optics, core optics, seismic isolation system on moving ground, suspension, sensors and actuators
 - » **field** : non-Gaussian field propagation through non perfect mirrors and lenses, misalignment and modal mismatch ..
 - » **feedback loops** : length and alignment controls, feedback to laser
 - » **non-linearity** : cavity dynamics to actuators
 - » **coupling** : alignment and longitudinal, frequency and motion, between arms
 - » **noise** : mechanical, thermal, sensor, field-induced, laser, etc : amplitude and frequency : creation, coupling and propagation
 - » **wide dynamic range** : $10^{-6} \sim 10^{-20}$ m

Current Team @ Caltech: B. Bhawal, M.Evans, V.Sannibale, H. Yamamoto



Time Line

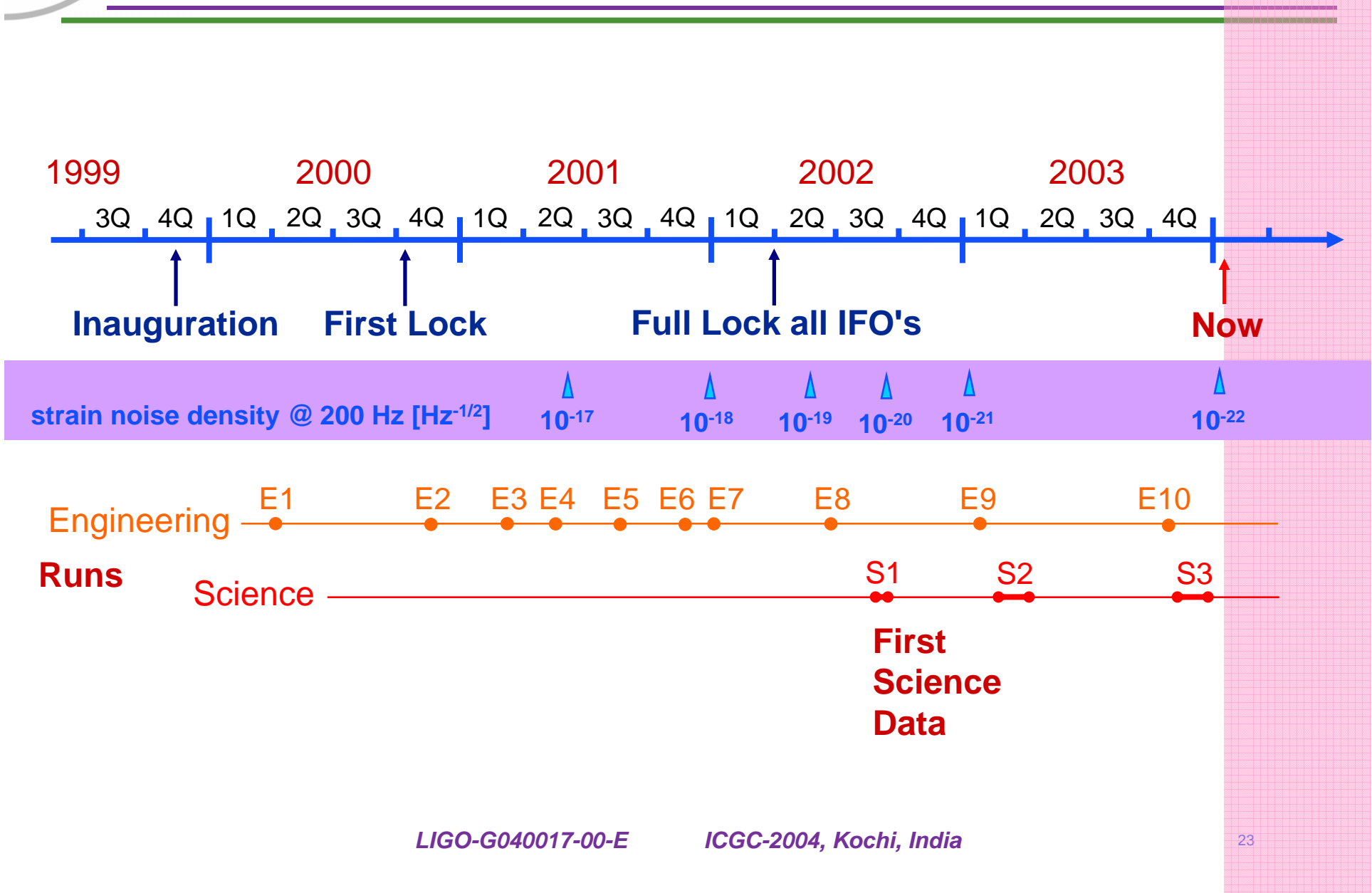



Hanford 2k simulation setup

6 independent suspended mirrors with seismic noise

corner station :
strong correlation in the low frequency seismic motion

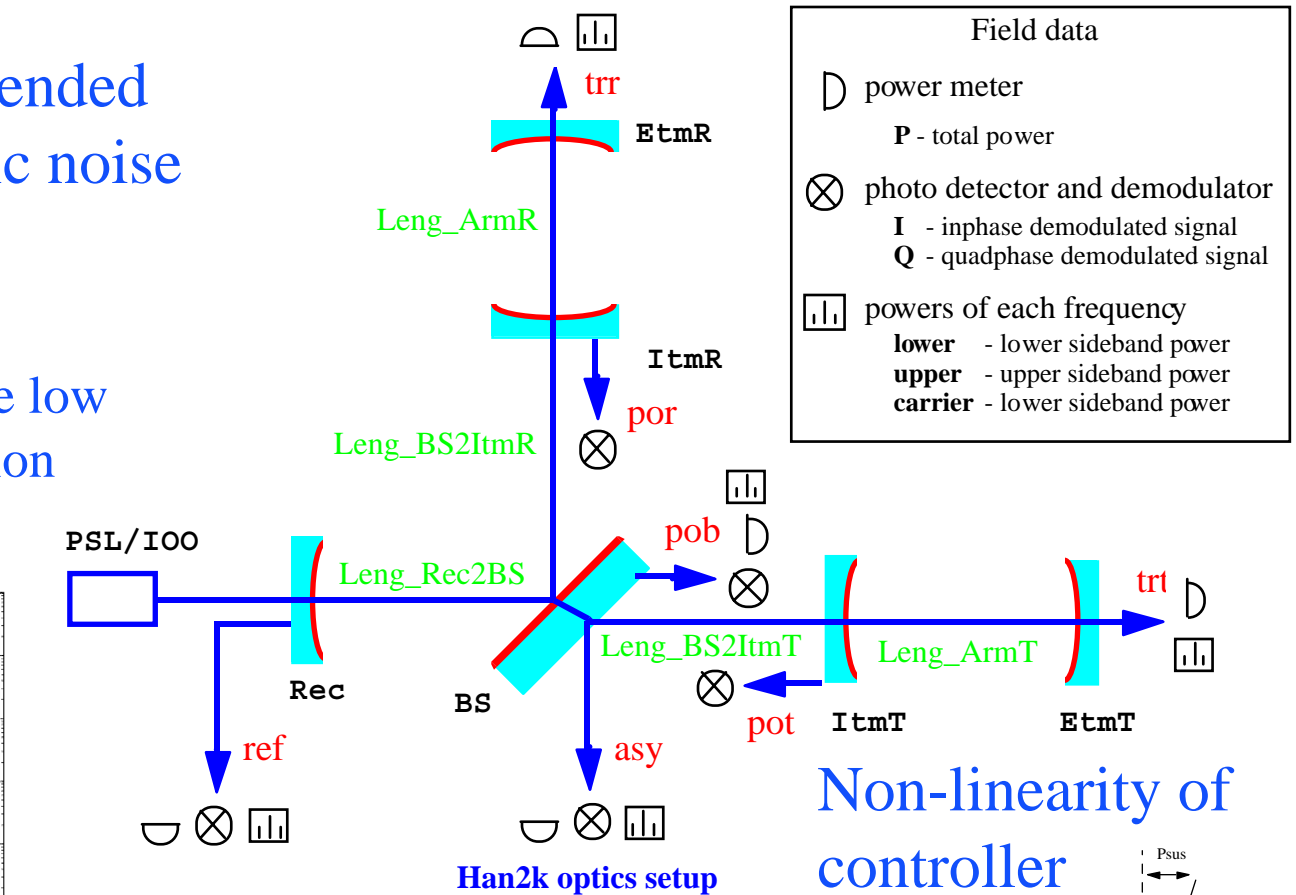
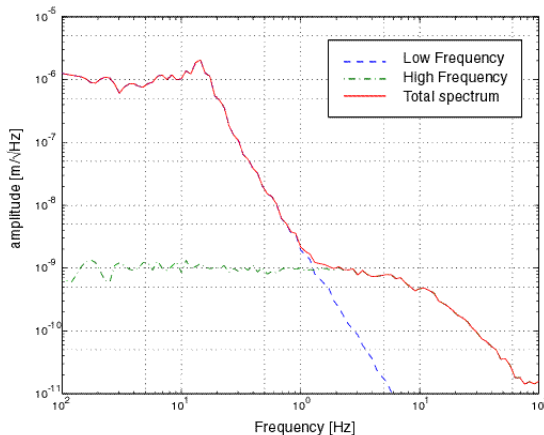

LIGO-G040017-00-E

ICGC-2004, Kochi, India

Non-linearity of controller

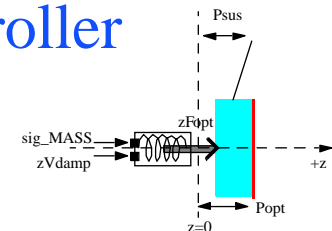

Multi step locking



State 1 : Nothing is controlled. This is the starting point for lock acquisition.

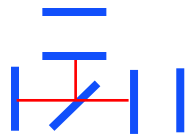

State 2 : The power recycling cavity is held on a carrier anti-resonance. In this state the sidebands resonate in the recycling cavity.

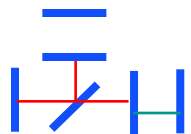

State 3 : One of the ETMs is controlled and the carrier resonates in the controlled arm.

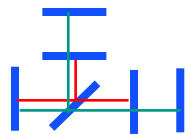

State 4 : The remaining ETM is controlled and the carrier resonates in both arms and the recycling cavity.

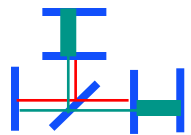

State 5 : The power in the IFO has stabilized at its operating level. This is the ending point for lock acquisition.



Lock acquisition

real and simulated

Figure 1. LHO 2k IFO data

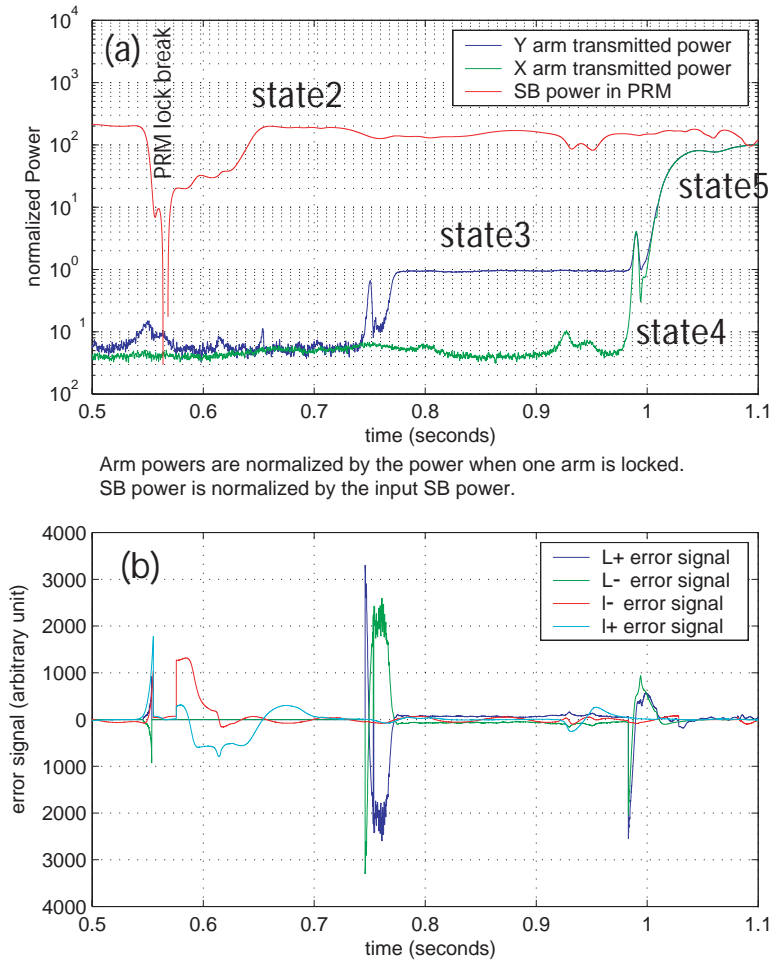

LIGO-G040017-00-E

Figure 2. Simulated signal

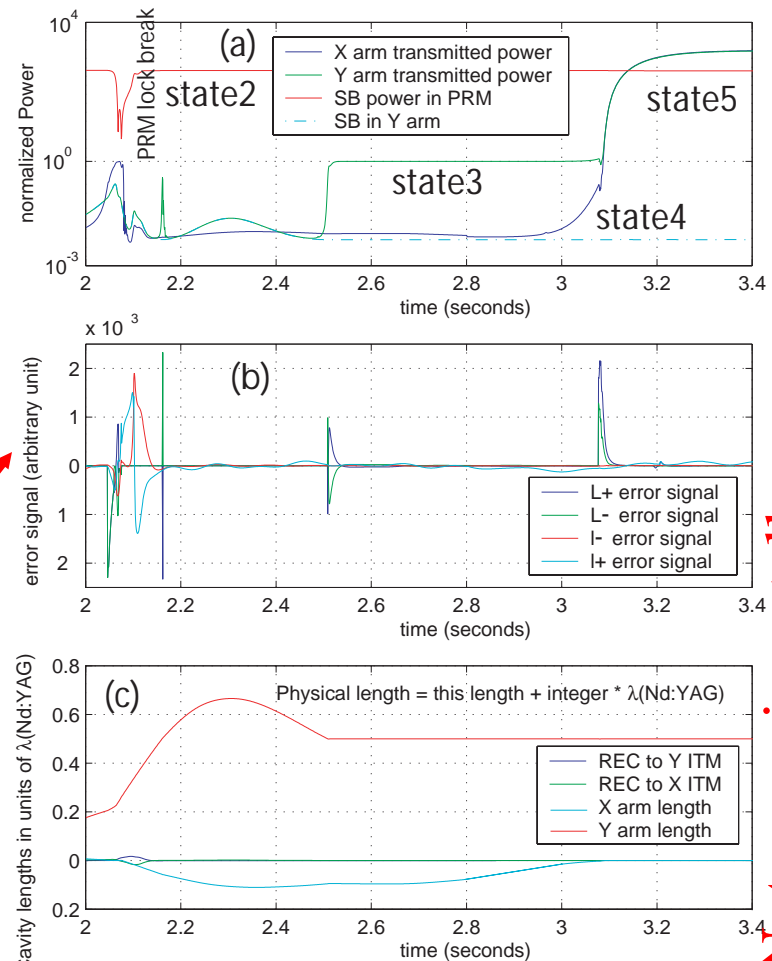

ICGC-2004, Kochi, India

observable

Not experimentally observable

Guided Lock Acquisition

- Fast sensors monitor circulating powers, RF sidebands in cavities
- Sequencing code digitally switches feedback state at proper transition times
- Loop gains are actively scaled (every sample) to match instantaneous carrier & sideband buildups
- Designed by Matt Evans (PhD thesis)

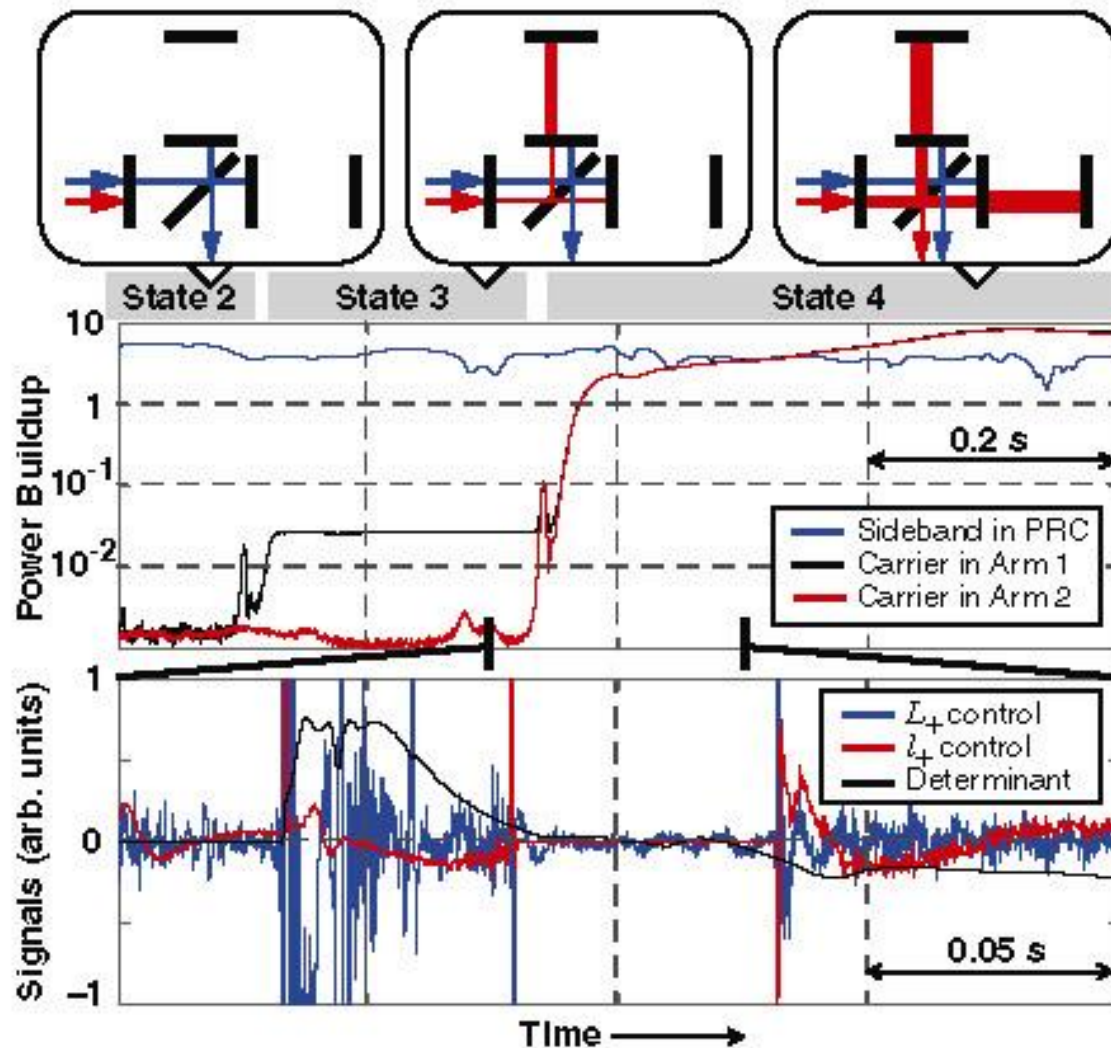



Tidal Compensation during locked state

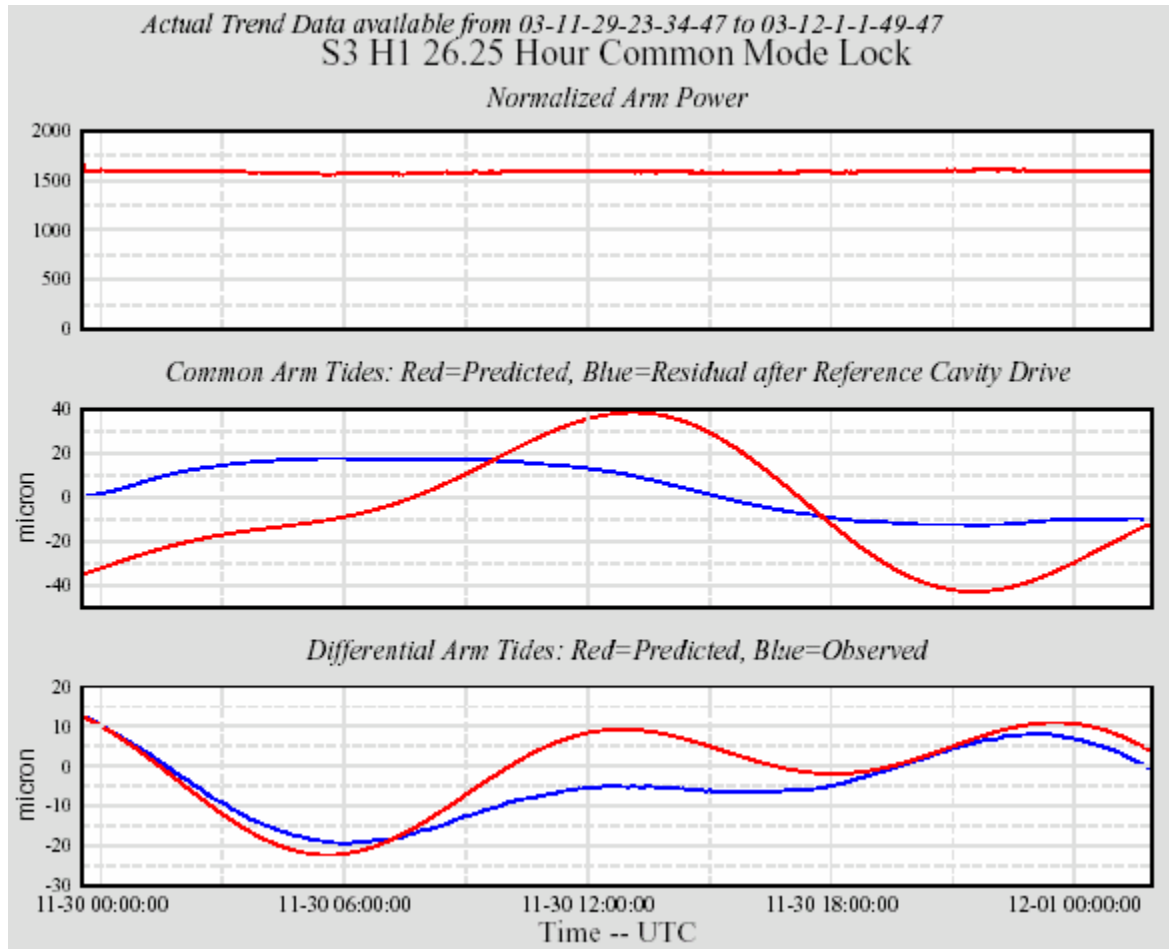

Daily strains

$\sim 3e-8$

For 4 Km

~ 120 micrometer

Misalignments: Cavity & its eigenmodes

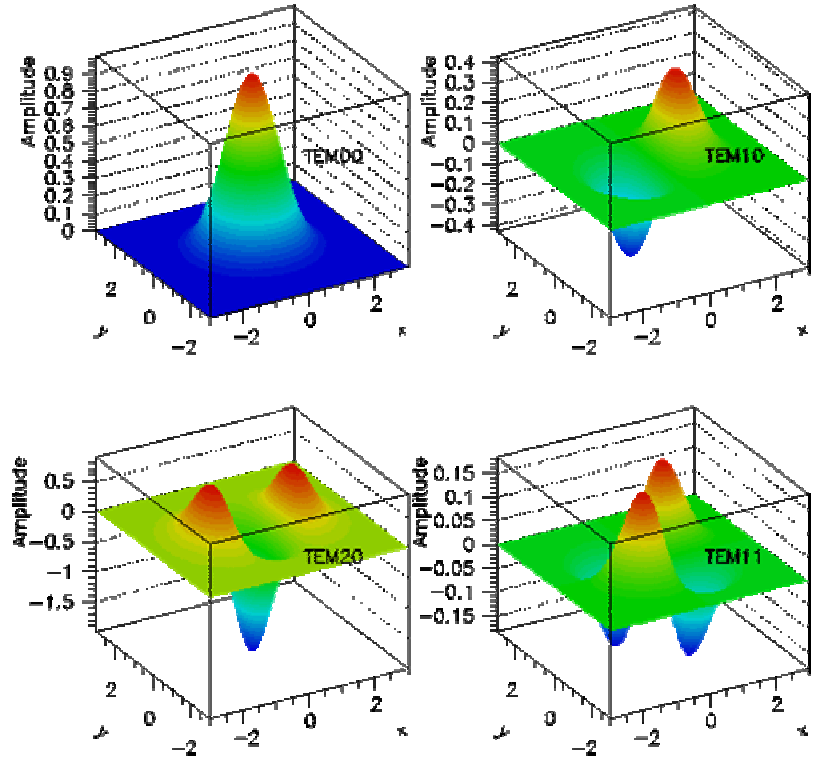
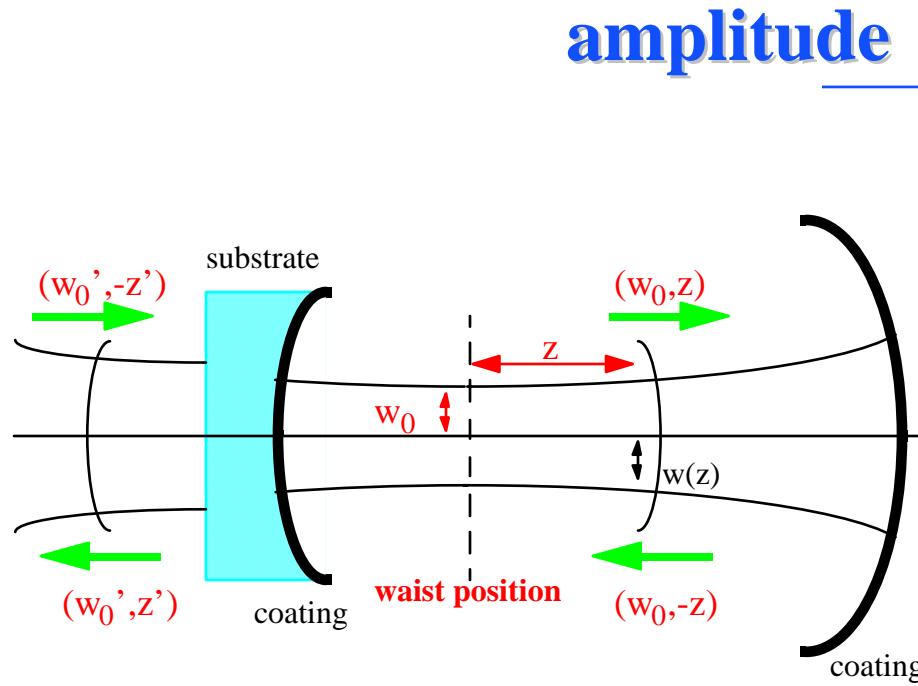

power

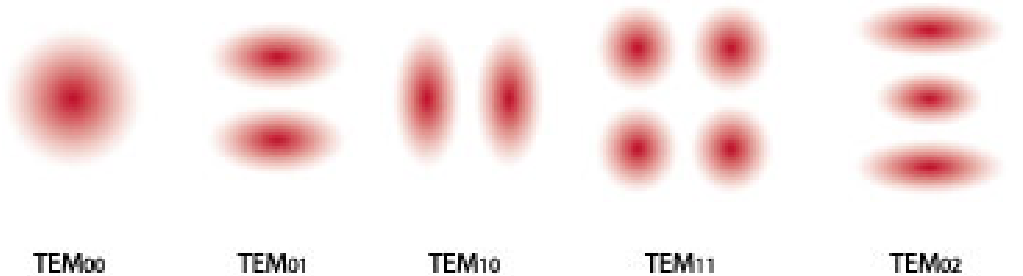

Perturbations on Beam

- Initial Beam: AU_0 with k (mode no.), w (waist)

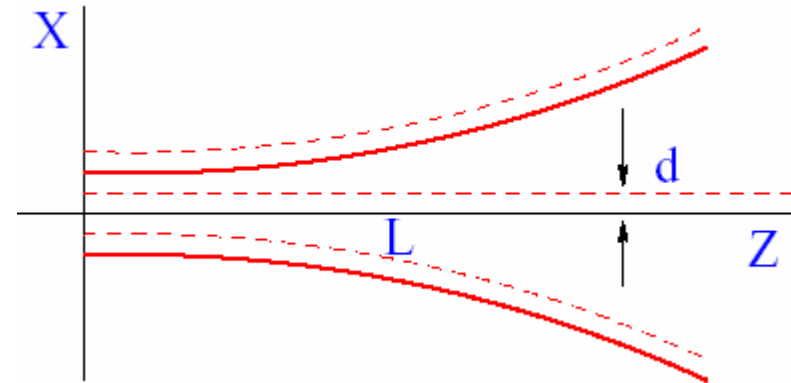
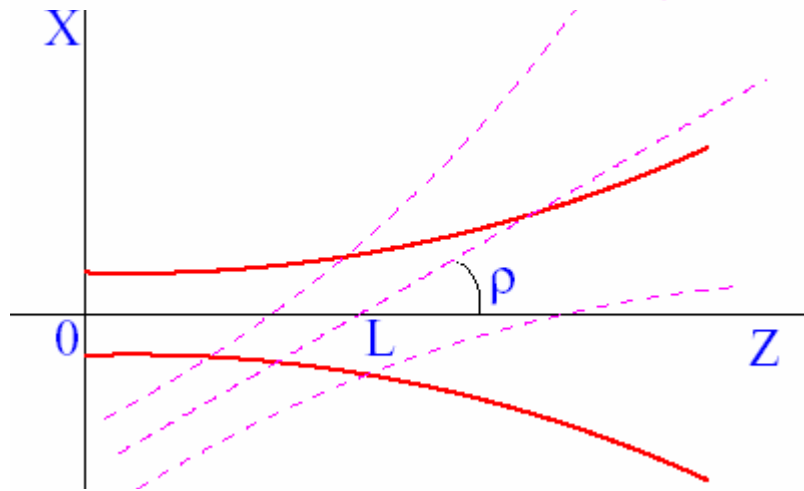

- Rotation (ρ): $A \left[U_0 + i\rho \frac{kw}{\sqrt{2\pi}} U_1 \right]$

- Lateral displacement (d): $A \left[U_0 + \left(\sqrt{\frac{2}{\pi}} \right) \frac{d}{w} U_1 \right]$

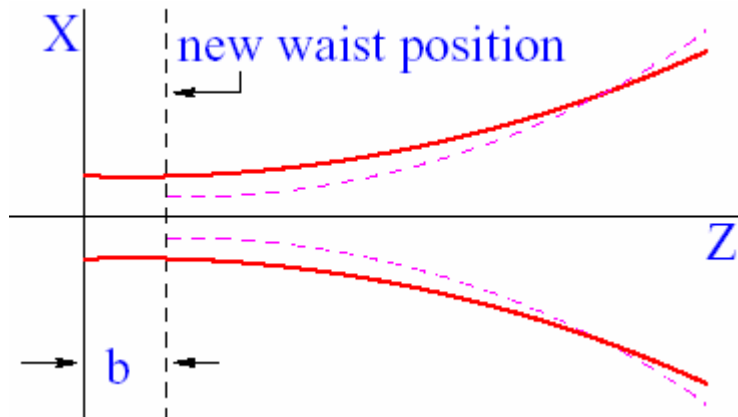

- Waist-position mismatch (b):

$$A \left[U_0 + i \frac{b}{2kw^2} \{ U_0 + U_2 \} \right]$$

- Waist-size mismatch (s): $A \left[U_0 + \frac{s}{2w} U_2 \right]$



Alignment Sensing and Control

- Alignment sensing and control
 - » Digital Control of 12 mirror angles and the input beam direction
 - » Requirement: angular fluctuations $<10^{-8}$ rad rms
 - » Wavefront sensors (split photodetectors)

Misalignment signal

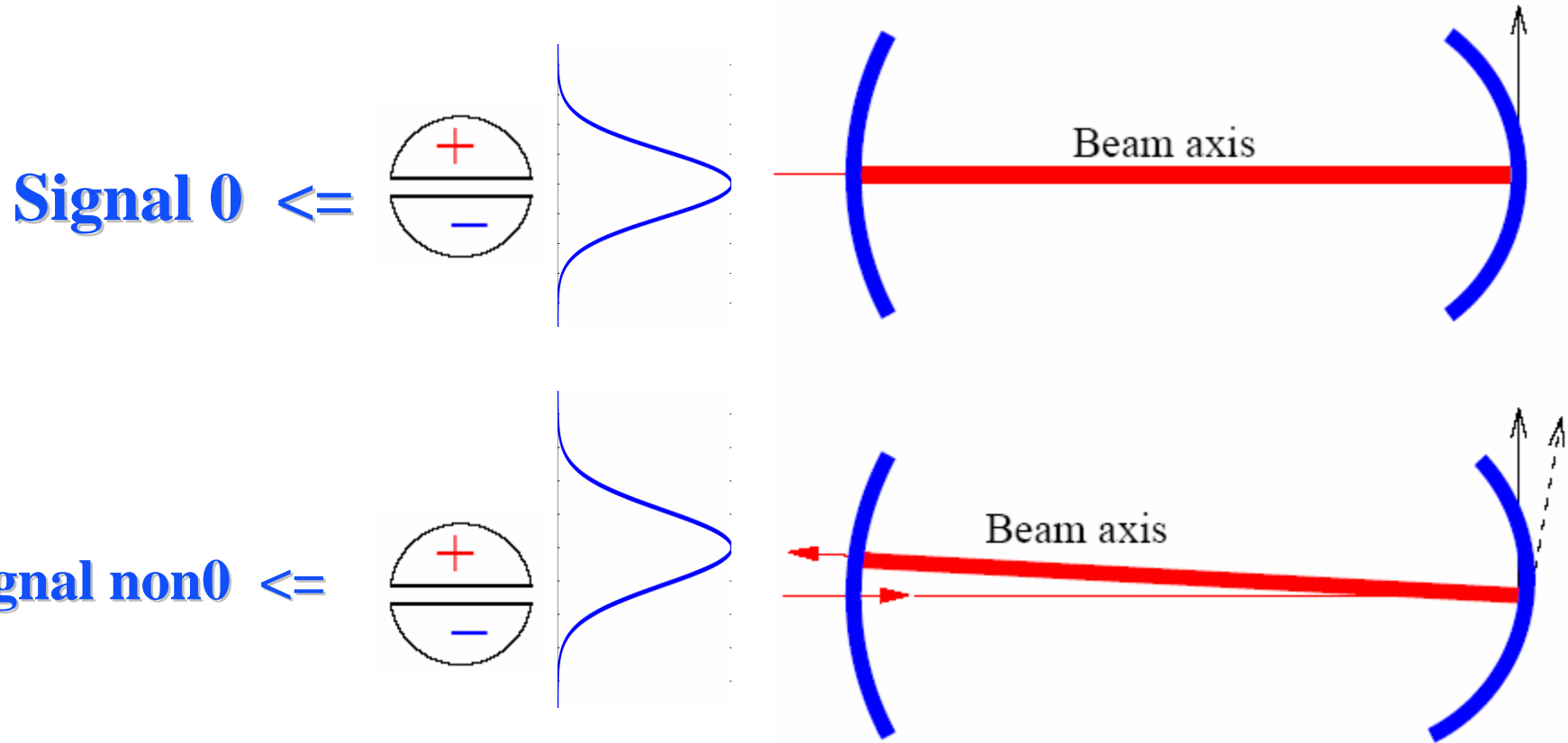



Higher Order Modes due to misalignment

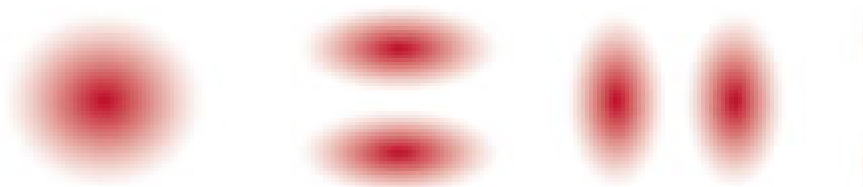

power

TEM₀₀

TEM₀₁

TEM₁₀

Signal in Radio frequency

- Signal- 1st Even term: $\propto CR_{00} \times SB_{00}^*$
- Signal- 1st Odd term: $\propto CR_{00} \times SB_{01}^* + CR_{01} \times SB_{00}^*$
 Or, $\propto CR_{00} \times SB_{10}^* + CR_{10} \times SB_{00}^*$

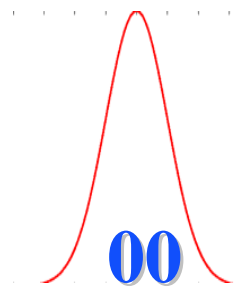

X

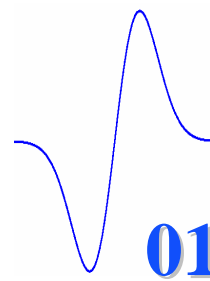

=

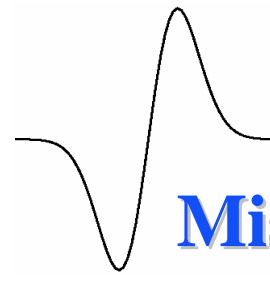

Misalign signal

LIGO-G040017-00-E

ICGC-2004, Kochi, India



Wave Front Sensor & Misalignment

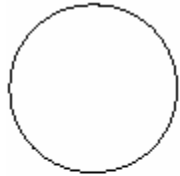

length-sensing
PD

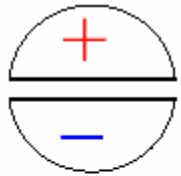

WFS-PD
for detecting
rotation around
horizontal axis
(mirror pitch)

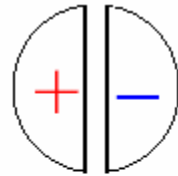

WFS-PD
for detecting
rotation around
vertical axis
(mirror yaw)

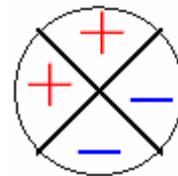

LIGO
WFS-PD

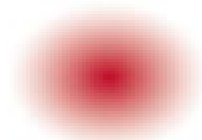

$CR_{00} \times SB_{00}$

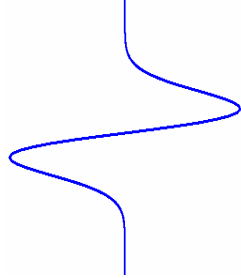

$CR_{00} \times SB_{01} + CR_{01} \times SB_{00}$

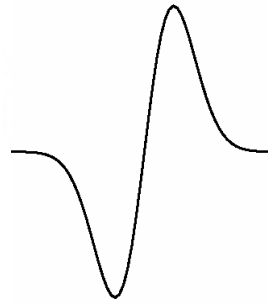

$CR_{00} \times SB_{10} + CR_{10} \times SB_{00}$

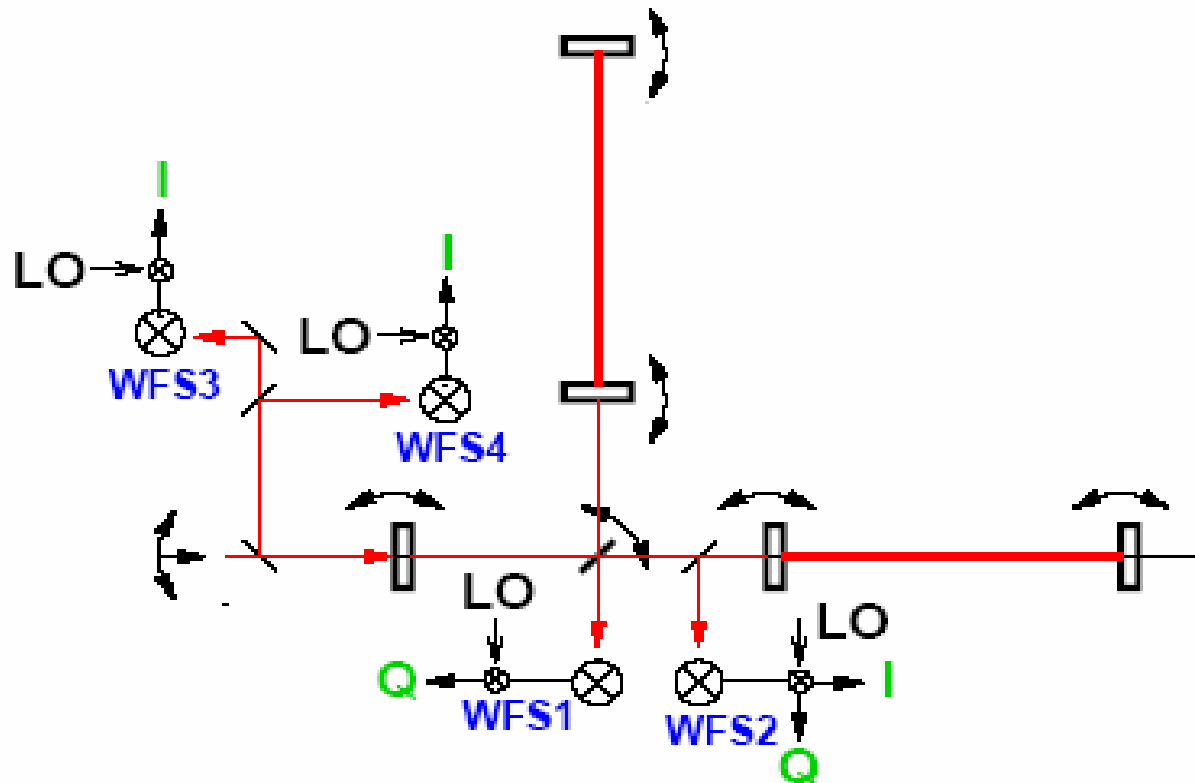
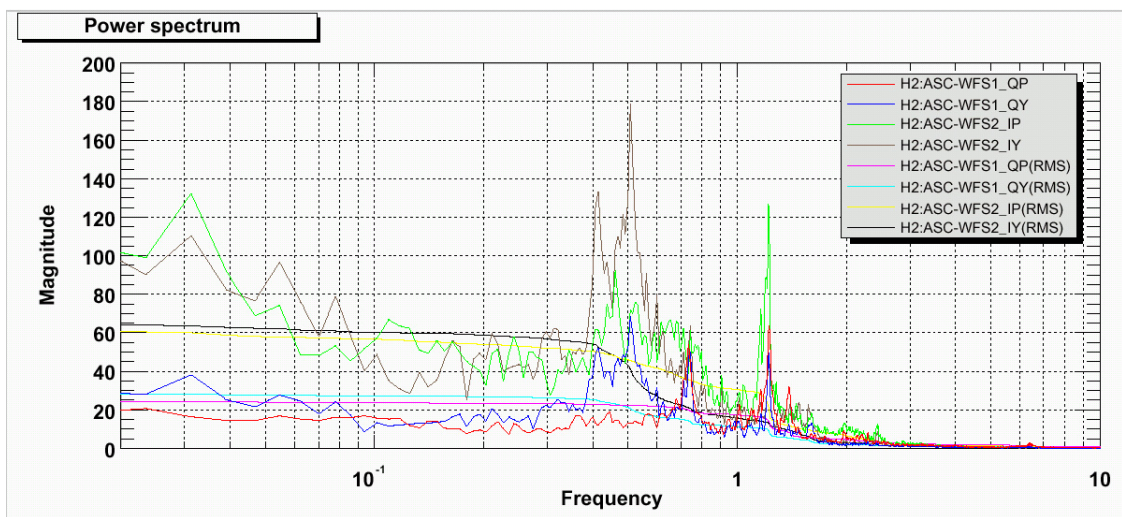

Figure 1: The location of the different WFSs in H_1 during S3.



Activation of Wavefront sensors

Alignment fluctuations before engaging wavefront sensors



After engaging wavefront sensors

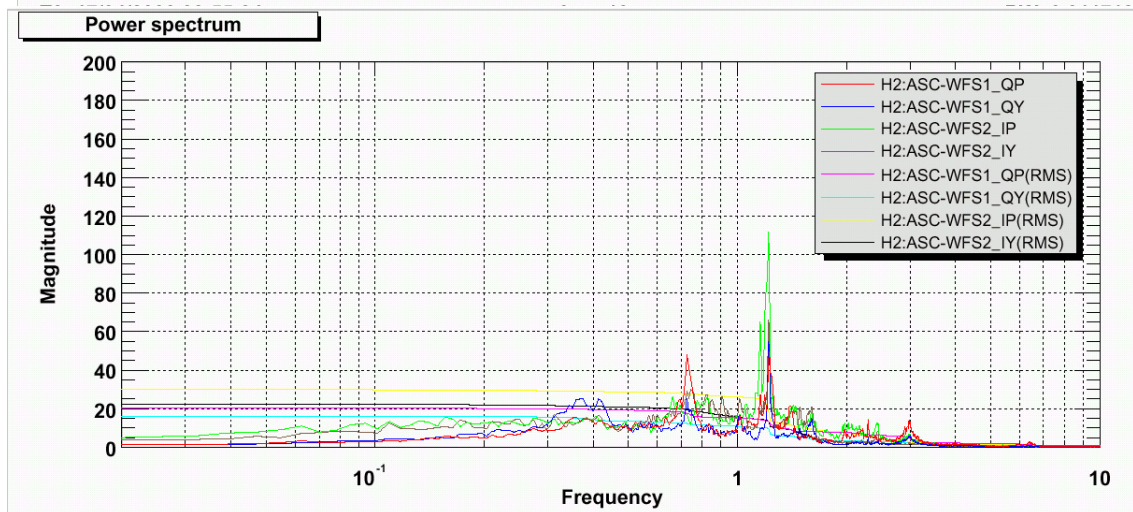



WFS Alignment System

WFS OFF

Arm Cavity Power

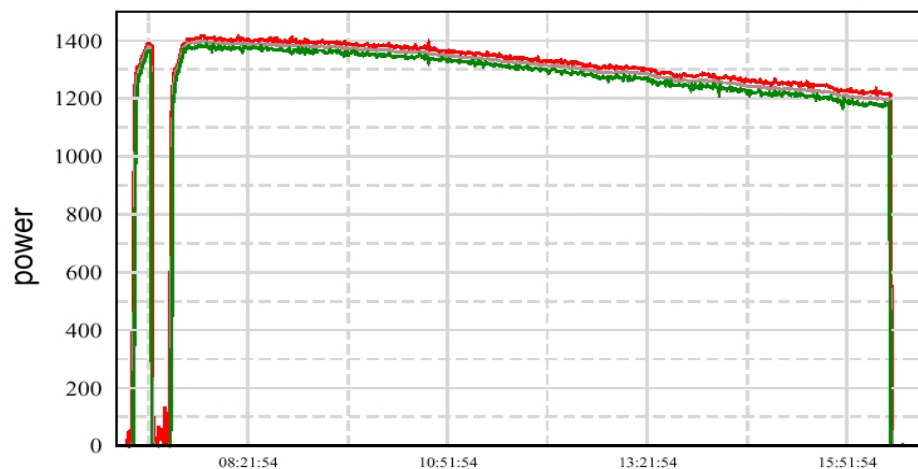

WFS ON

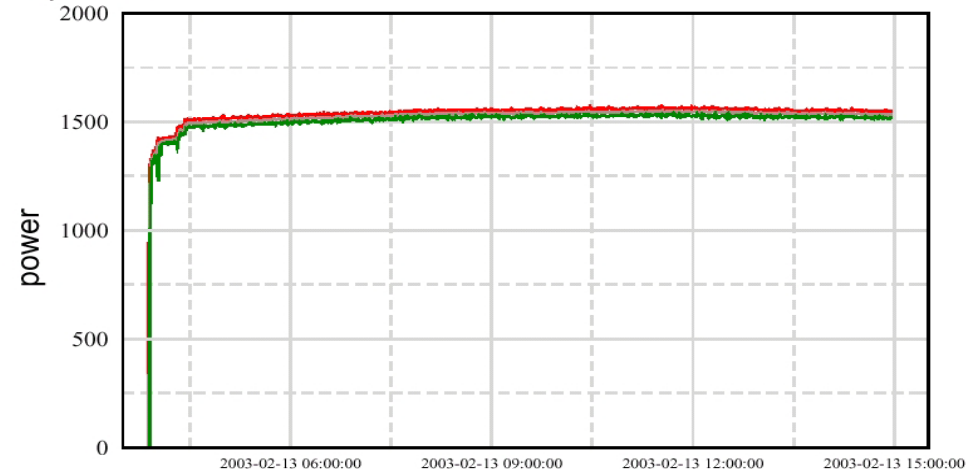

Anti-symmetric Port Power

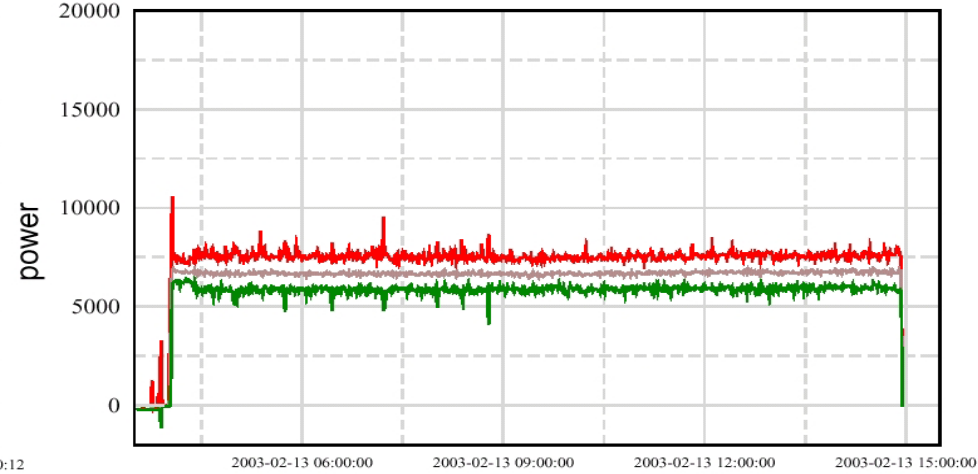
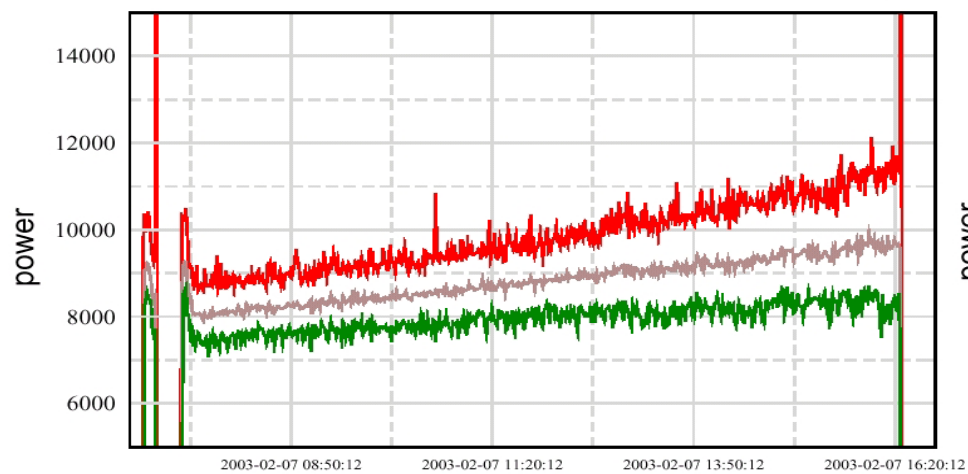

Thermal lensing

- Lens Definition: varying optical path length along trans direction
- Any concave LIGO mirror is a lens
- ... BUT Temperature gradient inside substrate
 - > gradient of refractive index across transverse direction
 - > Change in Optical path length across trans. direction
 - > Change in transmitted beam wavefront
- ...that's the effect of Thermal lensing



- Substrate heat absorption in Input mirror:
 - > $\text{InputPower} \times \text{RecyclingGain} \times \text{SubstrateAbsorpCoeff}$
- Surface heat absorption in Input mirror:
 - > $\text{InputPower} \times \text{RecyclingGain} \times \text{ArmGain} \times \text{SurfaceAbsorpCoeff}$

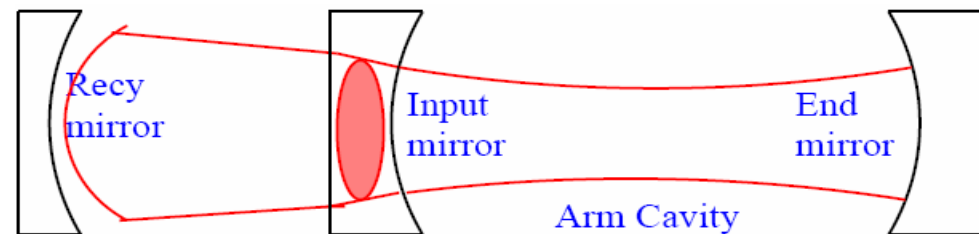

Mode-mismatch

Thermal Lensing in Input mirror

- » Carrier modes mainly determined by arms (negligible effect of thermal lensing on carrier in LIGO I)
- » Sidebands coupled into recycling cavity
- » Recycling cavity is **nearly degenerate** [small cavity (~9 m) with large mirror curvature (~15 km)
- » Original "point design" depends on specific, balanced **thermal lensing**:

Beam wavefront matches with Recycling mirror ROC when maximum hot (Problem: what happens if "maximum hot" state is different from prediction?)

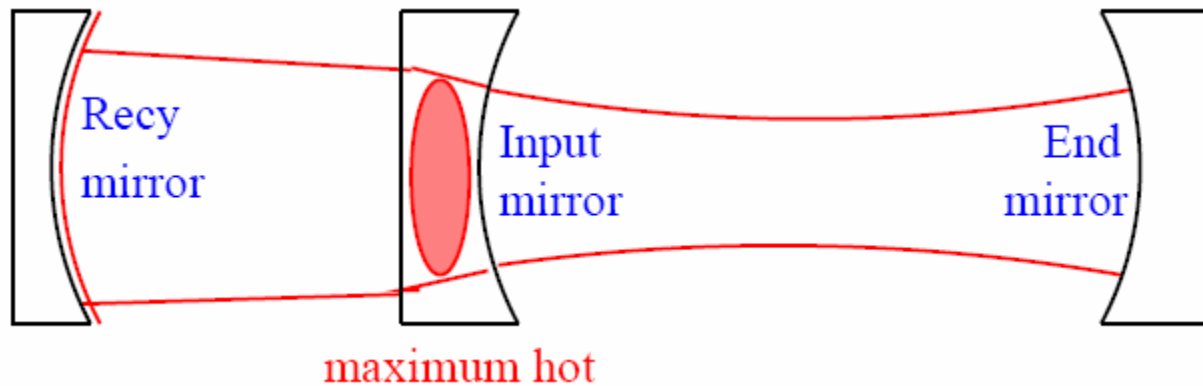

Bad mode-overlap for SBs

- RF sideband efficiency found to be very low
 - H1 efficiency: ~6% (anti-symmetric port relative to input)
 - incorrect/insufficient ITM thermal lens makes the recycling cavity an unstable resonator

⇒ Bad mode overlap!

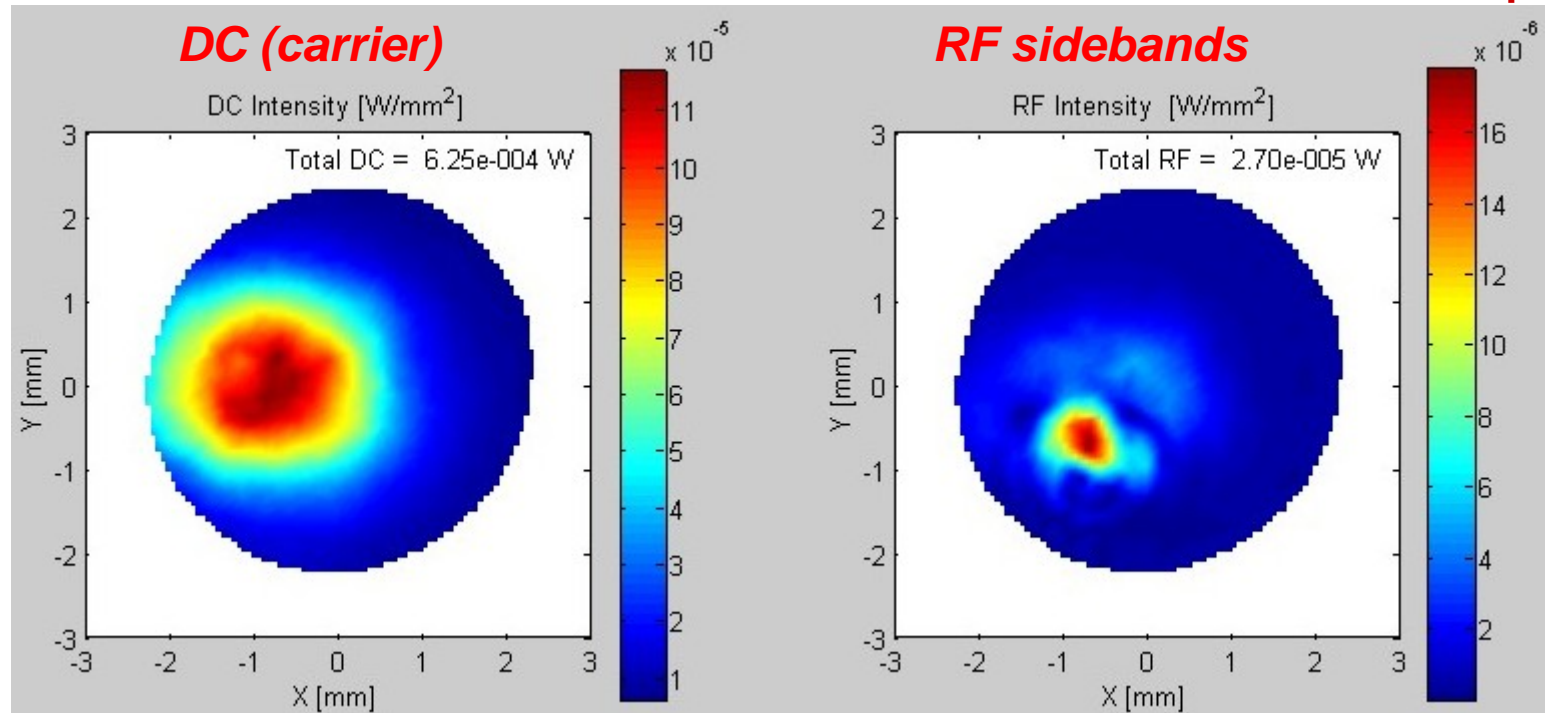

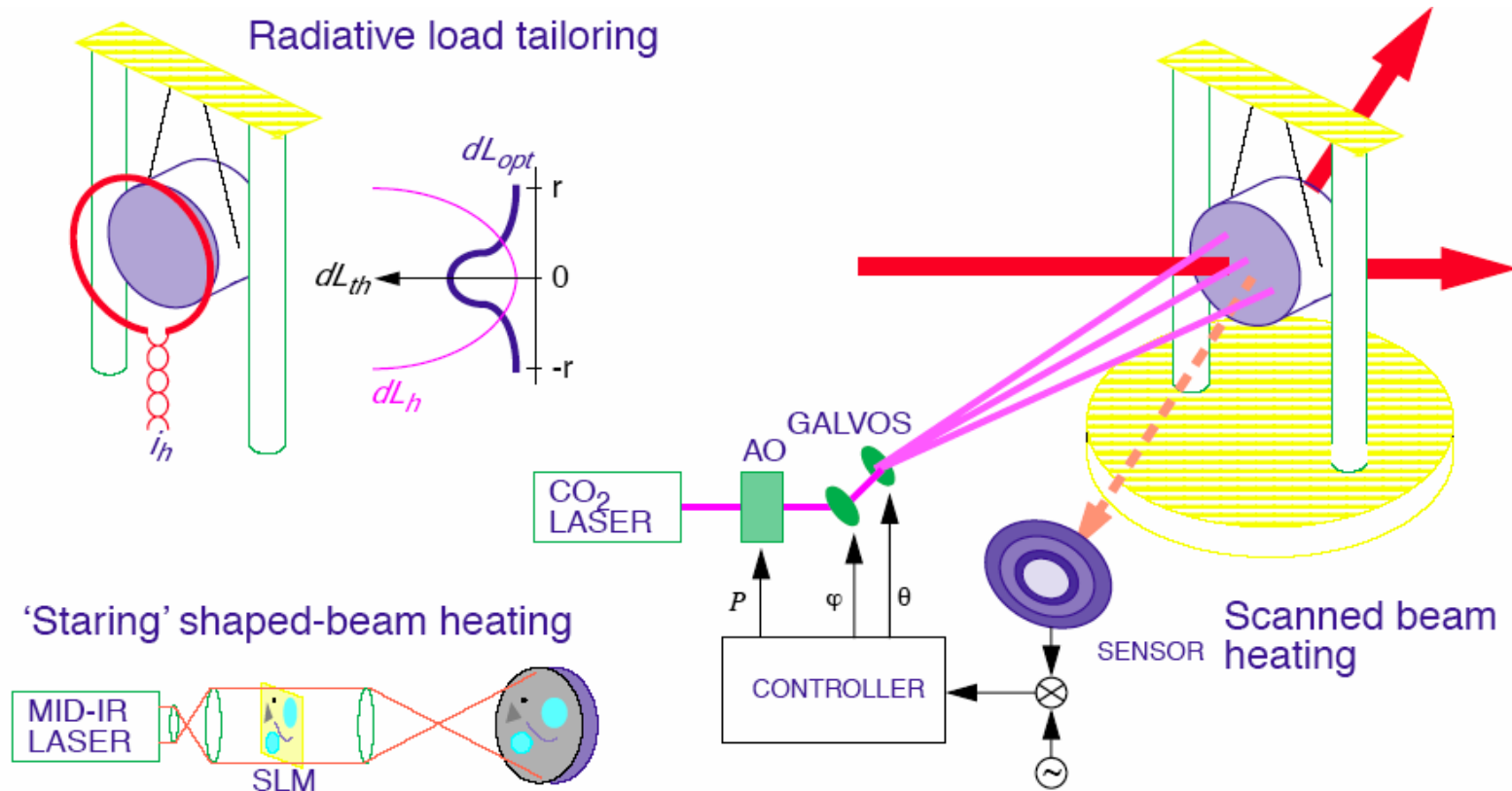

- 10W CW TEM00 CO2 Laser (10.6mm)



Time Line

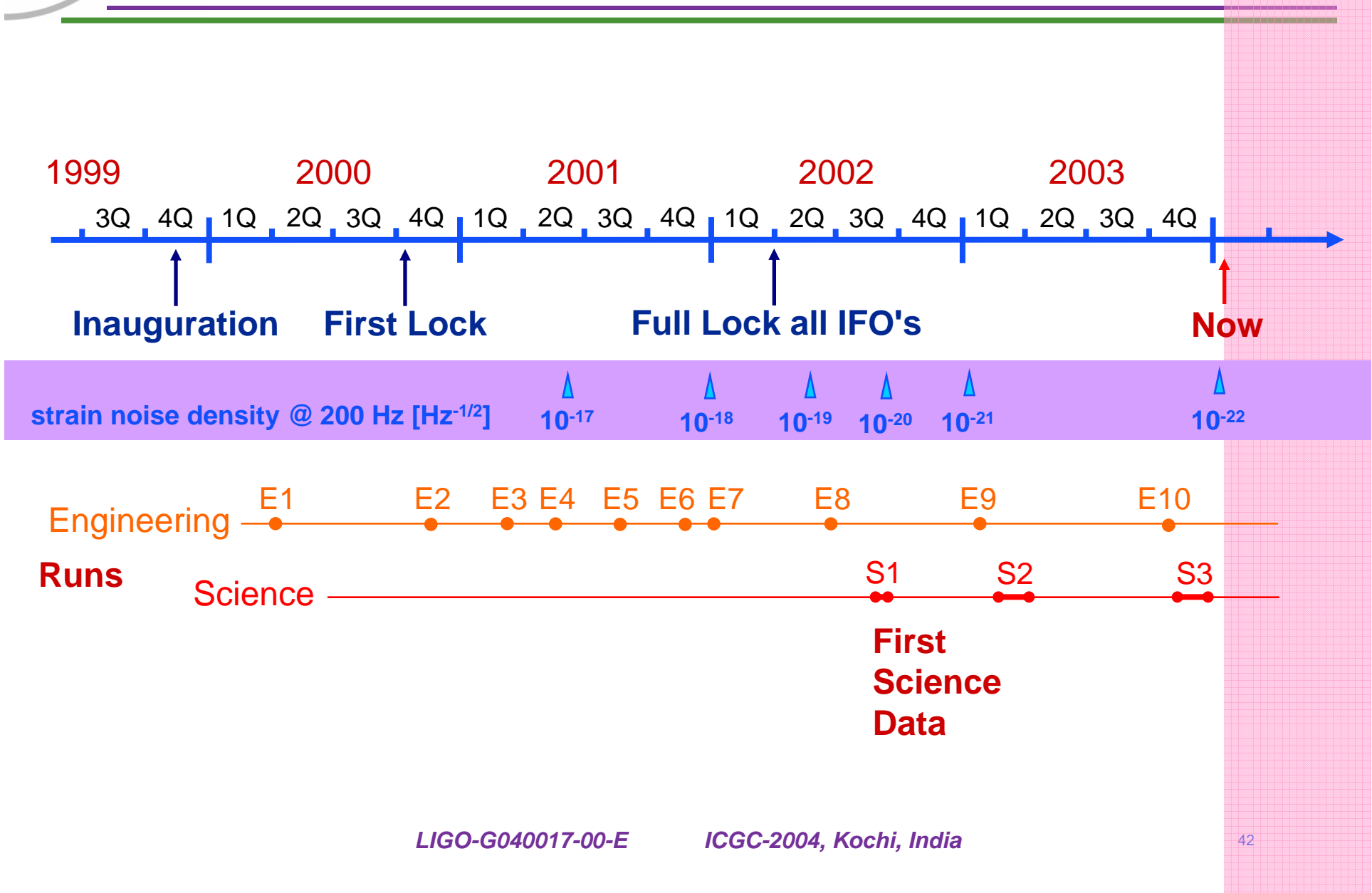



Advanced LIGO: Dual Recycling

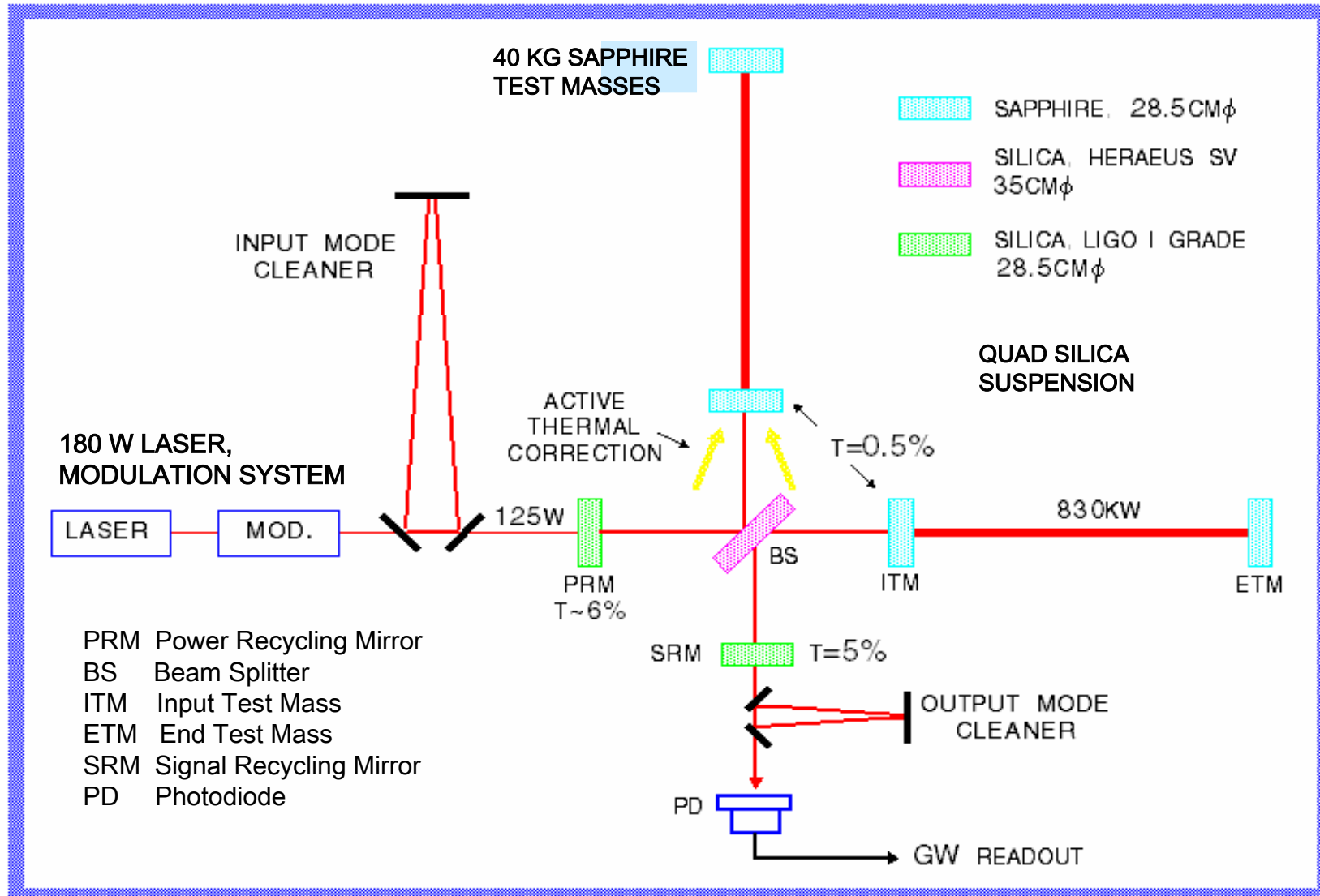

Active Seismic



Higher Power Laser

Dual recycling

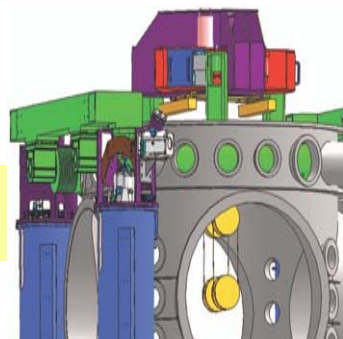

Multiple Suspensions

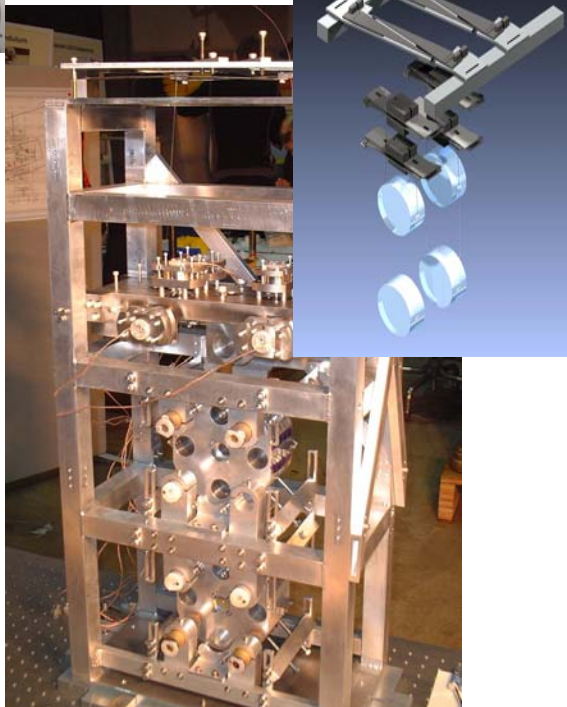

Silica Suspension

Sapphire Optics

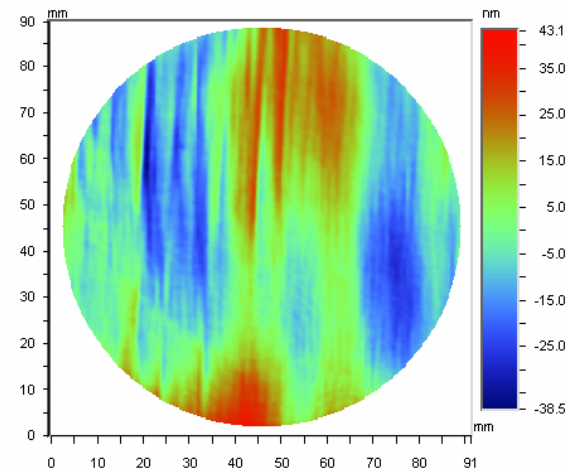

Date: 10/25/2001
 Time: 13:59:18
 Wavelength: 1.064 μm
 Pupil: 100.0 %
PV: 81.6271 nm
RMS: 13.2016 nm

X Center: 172.00
 Y Center: 145.00
 Radius: 163.00 pix
 Terms: None
 Filters: None
 Masks:



Anatomy of the projected Advanced LIGO detector performance

- Newtonian background, estimate for LIGO sites
- Seismic 'cutoff' at 10 Hz
- Suspension thermal noise
- Test mass thermal noise
- Unified quantum noise dominates at most frequencies for full power, broadband tuning

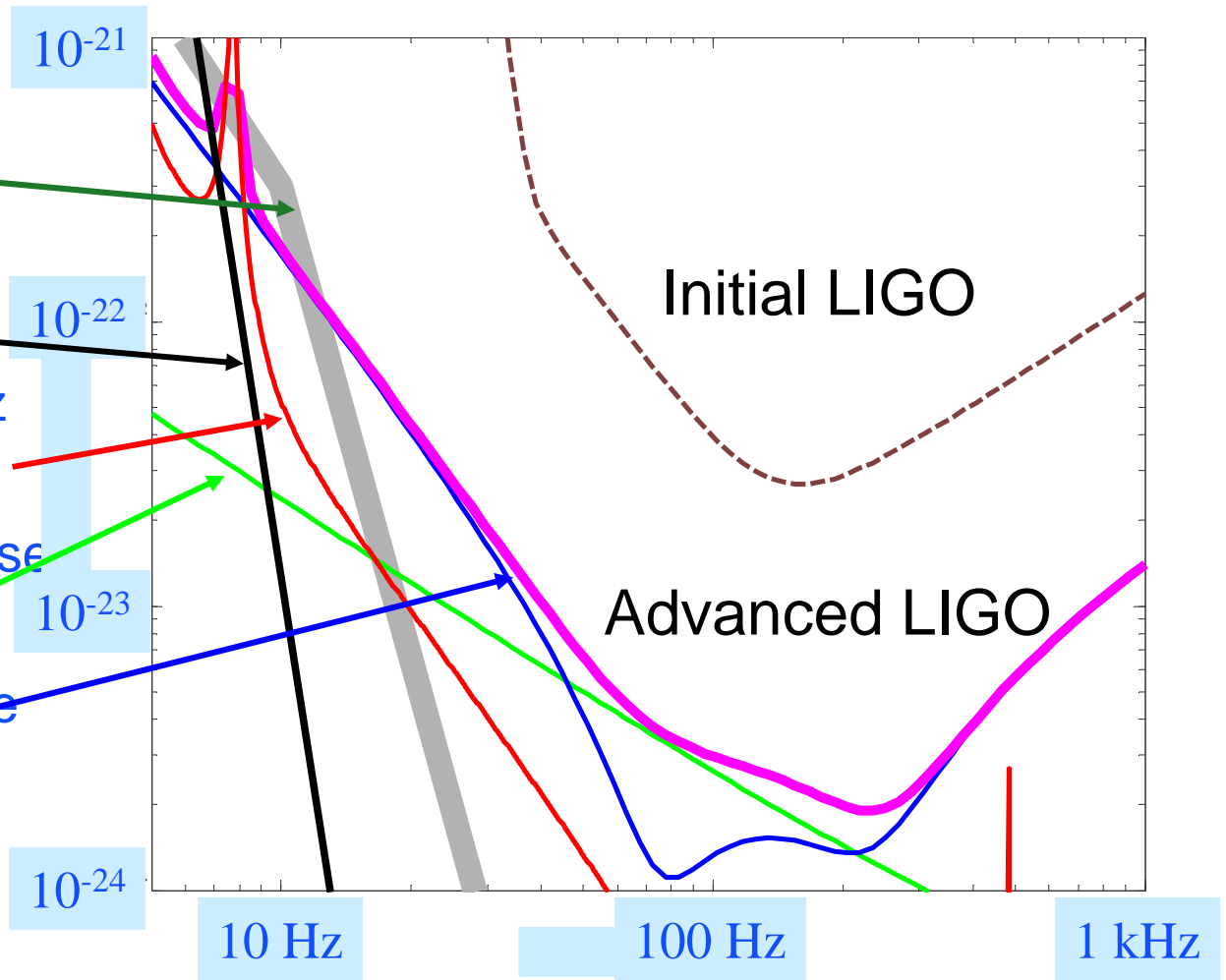



How much of sky can we see?

Improve amplitude sensitivity by a factor of 10x, and...

⇒ Number of sources goes up 1000x!

