

# LIGO ADVANCED SYSTEMS TEST INTERFEROMETER (LASTI)

---

Program Update:

LSC Meeting, Hanford  
Dave Ottaway for the LASTI team  
August 2004

LIGO-G040388-00-Z

# Talk Overview

---

1. Short review of LASTI goals
2. Concerns raised at previous review
3. Progress since Nov 03
4. Medium term detailed plans and general long term goals
5. Conclusions

# LASTI Mission

---

- Test LIGO components & systems at **full mechanical scale**
- Practice installation & commissioning
- Minimize delays & downtime for advanced LIGO upgrades
- Qualify design modifications & retrofits for initial *LIGO*

## **Specific Advanced LIGO Program Tasks ('01 - '06+):**

- Qualify advanced isolation & suspension systems and associated controls at full scale
- Develop detailed SEI/SUS installation & commissioning handbook
- Look for unforeseen interactions & excess displacement noise
- Test PSL and Input Mode Cleaner together at full power

# LASTI People

## Resident MIT Staff

- **Students** - Laurent Ruet (PhD student at INSA)
- **Engineering** - Myron MacInnis, Ken Mason, Jonathan Allen
- **Scientists** - Gregg Harry, Rich Mittleman, Dave Ottaway, David Shoemaker, Pradeep Sarin, Mike Zucker (Advice)
- **Computers** – Keith Bayer

## Laboratory and LSC Visitors (to date)

- **Initial SEI & SUS**- Corey Gray, Hugh Radkins, Gary Traylor, Harry Overmier, Betsy Bland, Jonathan Kern, Marcel Hammond, Dennis Coyne...
- **Advanced SEI** - Joe Giaime, Brian Lantz, Wensheng Hua, Corwin Hardham, Samir Nayfeh and Lei Zuo
- **Advanced SUS** - Norna Robertson, Calum Torrie, Janeen Romie, Phil Willems, Justin Greenhalgh, Ken Strain, Caroline Cantley, Mark Barton...
- **CDS/DAQ** - Jay Heefner, Rus Wooley, Paul Russel...

# LASTI Advanced LIGO R&D Program

---

- Commission infrastructure (vacuum, cleanrooms, cranes...)
- Commission PSL & controls
- Commission initial seismic stack, suspensions & 1m test cavity in HAM chamber
- Develop & test EPI for LLO seismic remediation
- Qualification test of early pre-prototype triple pendulum
- Integrate/test active BSC SEI pathfinder
- Integrate/test active HAM SEI pathfinder (Significant Delay)
- Integrate/test Quad and Triple suspensions
- Integrate/test sapphire & fused silica core optics
- Qualify for low displacement noise with sensitive interferometer system
- Integrate and test full scale adaptive thermal compensation
- Integrate/test AdLIGO 180 Watt PSL & Mode Cleaner

# Since the Last Review

---

At the last review TAC requested:

- Optical Layout prepared by this review
- Detailed Schedule completed by this review
  - » Completed thru till start of 2006
  - » Beyond that this is effected by tight budgetary conditions

LASTI major progress since review

- Adaptive feedforward system developed for HEPI HAM
- Mode cleaner controls prototype installed in Xend HAM
- LASTI local staff contributed significantly to Livingston HEPI and TCS (Tested at LASTI)
- Laurent Ruet has decided to do a PhD focusing on LASTI related work

# LASTI Detailed Optical Layout

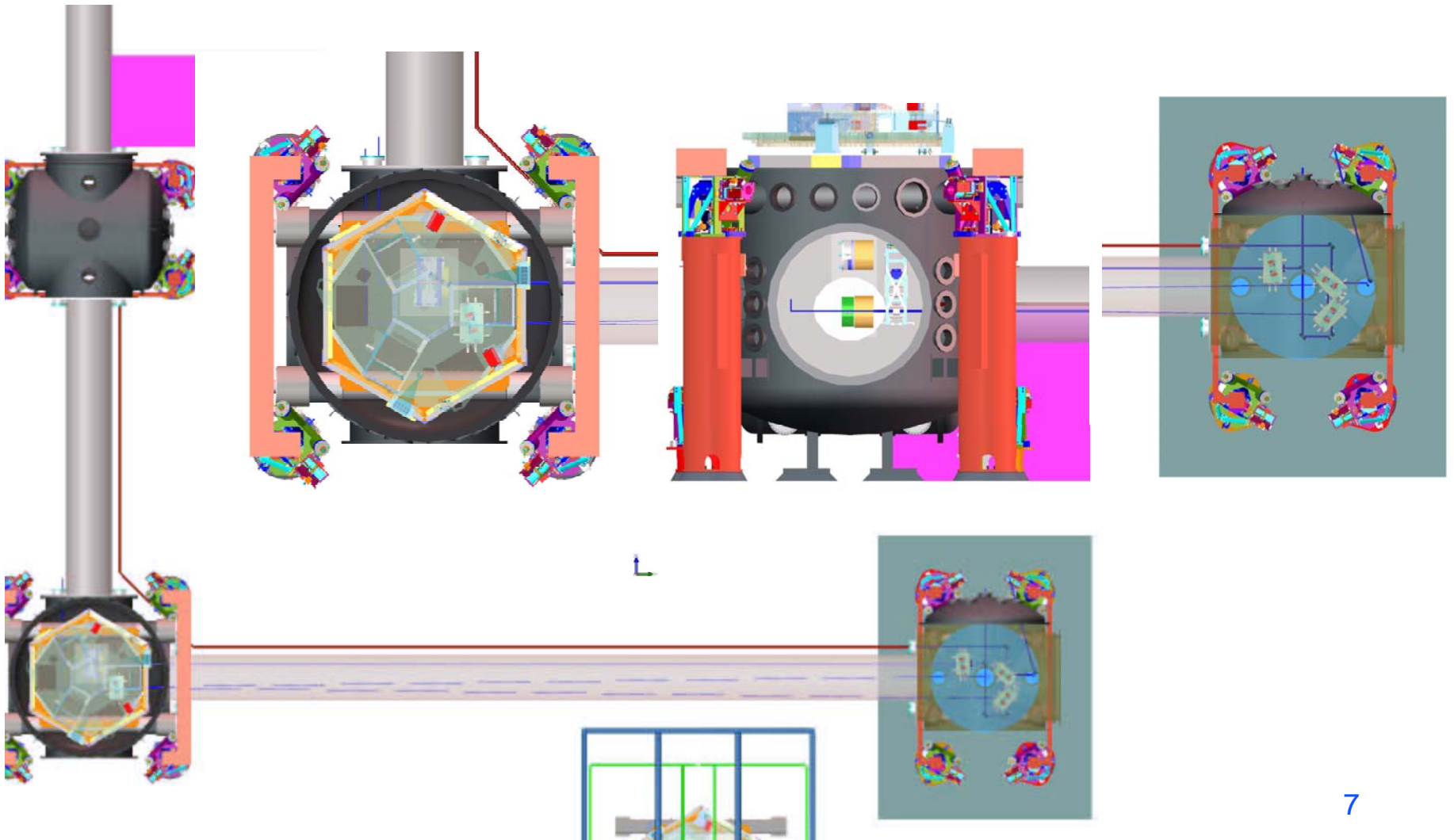

# MC Triple Prototype Installation Test



- MC Controls Prototype successfully installed in Xend HAM
- Documentation being prepared
- Preparing for 6 DOF shake test



# HEPI HAM Adaptive Feedforward

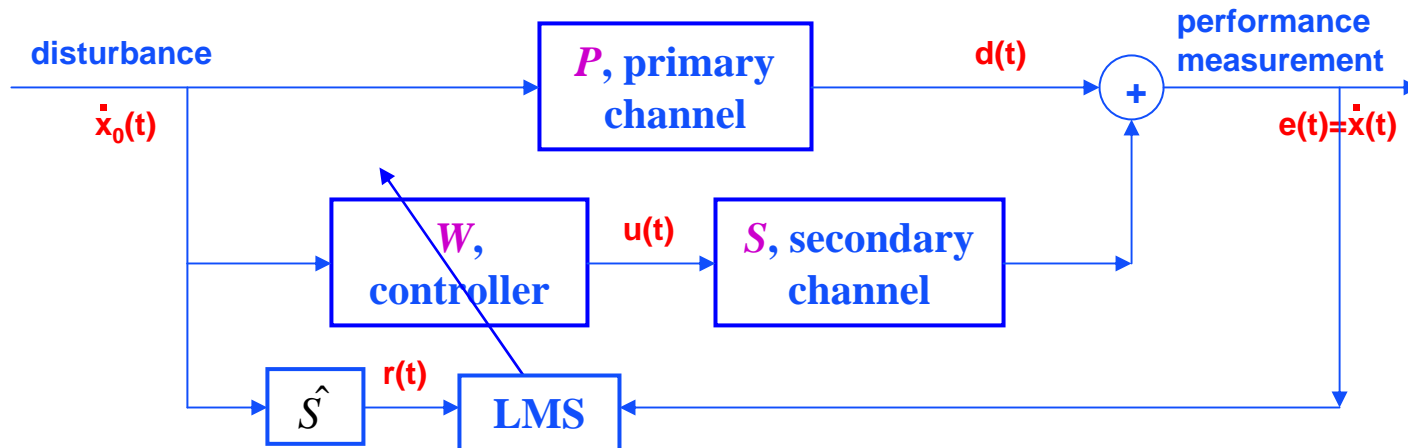

- Suggested to us by Samir Nayfeh and Lei Zuo
- Uses a witness to continually update a FIR filter controller
- Utilizes that transfer function for secondary channel is easy to measure c.f with primary channel

- Tried successfully using witness geophones mounted on the optical table
- More recently used support table geophones ie in build HEPI sensors

# HEPI Adaptive Feedforward Results

X Direction Optical Table Transfer Functions

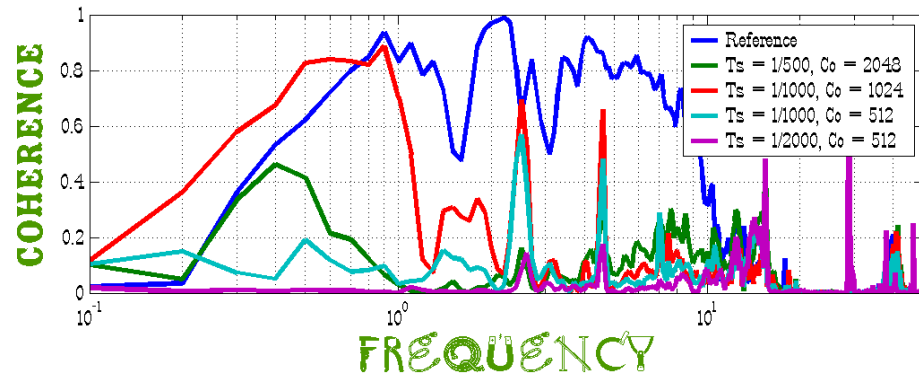
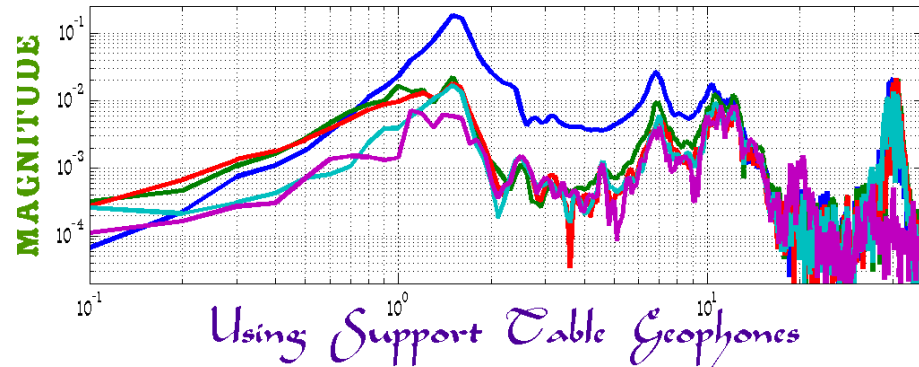

X Direction Support Table Transfer Functions

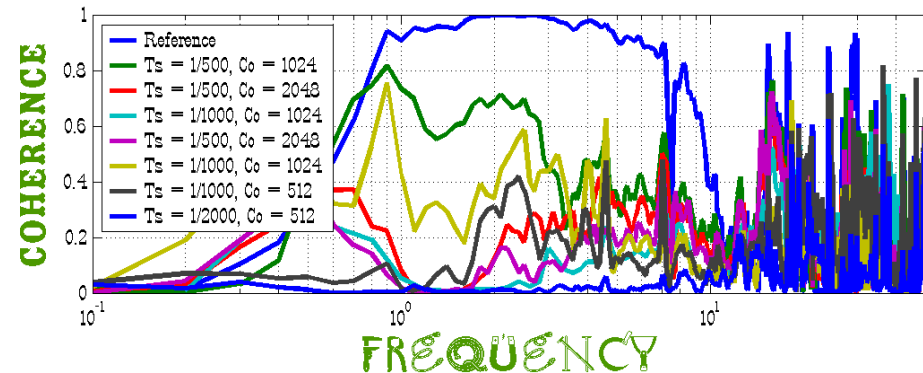
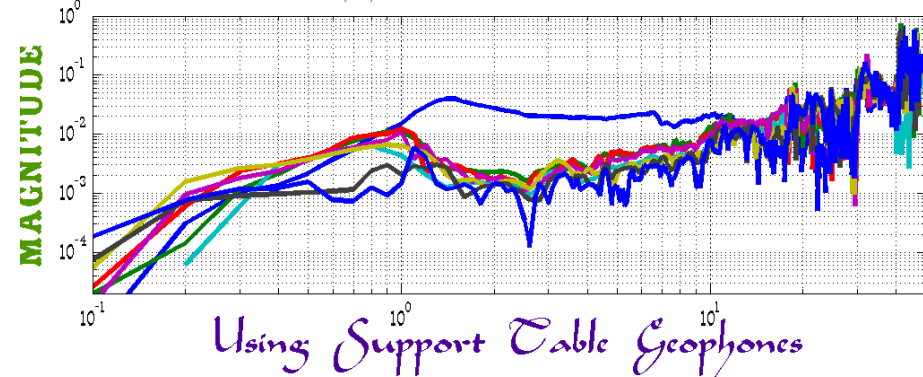

- Achieved using monitoring from support table geophones
- 3 Translational DOF of freedom isolation

## LASTI Height Issues Resolved

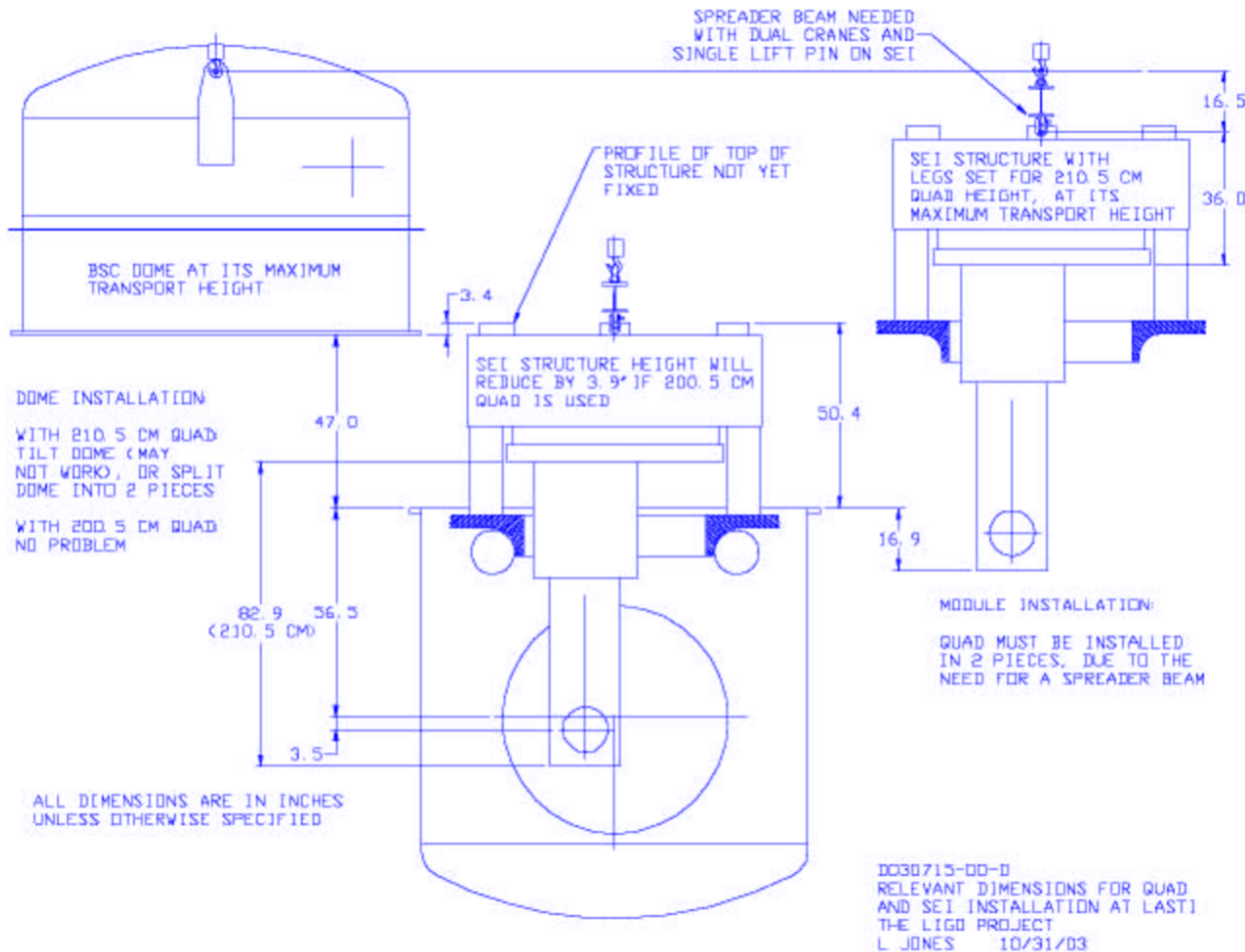

- LASTI roof lower than observatory
- LASTI constraints should not drive AdvLIGO requirements and design
- Seismic design has eliminated this problem
- Suspension will still need to be split

# Short term plans (ie 6months)

---

- Continue with MC Triple Testing
- Remove and store the LIGO 1 BSC Seismic Isolation
- Prepare tooling for installation of Advanced LIGO Seismic and Controls Prototype
- Install Advanced LIGO Seismic and controls prototype

# LASTI Schedule (Detailed-Short Term)

---

June '04	MC Triple installed at LASTI
June '04	Design of LASTI Noise Optics to COC [CODS and Budget]
June '04	Commence optical and electronic design for controls cavity tests ie readout design, wavefront sensors
July '04	HEPI Installed under Xend HAM
Aug '04	Start transfer function tests of the MC Triple using HEPI excitation
Aug '04	Budgetary estimate for LASTI for 2005 [Management]
Sept '04	Controls optical design and electronic design completed [LASTI]
Oct '04	Commence acquisition of additional components for LASTI Controls prototype optics and electronics [LASTI and CDS]
Nov '04	Report on MC Triple installation and LASTI tests [LASTI and SUS]
Jan '05	Receive Quad Controls Prototype [SUS]
Feb '05	Assemble Quad Controls Prototype [SUS]
Mar '05	BSC Advanced LIGO Seismic arrive at LASTI [SEI]
Apr '05	Assemble BSC Adv. LIGO SEI and fit-check [LASTI AND SEI]
May '05	Cartridge install Quad / BSC Seismic Isolation [LASTI]

# LASTI Schedule (Longer Term)

- 4Q02: MC triple suspension prototype installed for “controls” pre-test begins
- 2Q05: BSC SEI pathfinder installed for standalone testing
- 2Q05: Quad controls prototype
- 4Q05: HAM SEI pathfinder installed for standalone testing
- 1Q06: LASTI noise test begins; SUS prototypes installed
- 3Q06: Interferometric displacement tests
- 4Q06: Thermal compensation integration and test
- 1Q07: LASTI SUS/SEI test review
- 3Q07: Adv LIGO PSL/MC tests start (180 Watts)

**Depends heavily on available funds**

# Conclusions

---

- Optical layouts and detailed medium term schedules completed
- MC triple controls prototype installation completed and functionality test have commenced
- Overview of long term plans presented, more details will be added when funding picture becomes clearer