

Development of a CO₂ laser machine for pulling and welding of silica fibres and ribbons

G. Cagnoli¹, C. A. Cantley¹, D. R. M. Crooks¹,
R. A. Jones¹, J. Bogenstahl², P. Holt¹

¹ IGR, University of Glasgow

² University of Hannover

GR17 Dublin 2004

LIGO-G040433-00-K



Isolation of test masses: mission

- Provide isolation of the test masses from **seismic noise** whilst minimising **thermal noise**
 - **seismic noise:**
ground motion inversely proportional to frequency squared: seismic noise important below ~ 50 Hz
 - **thermal noise:**
most significant noise source in current detectors at low frequency end of operating range (~ 50 Hz to a few hundred Hz)

GEO 600

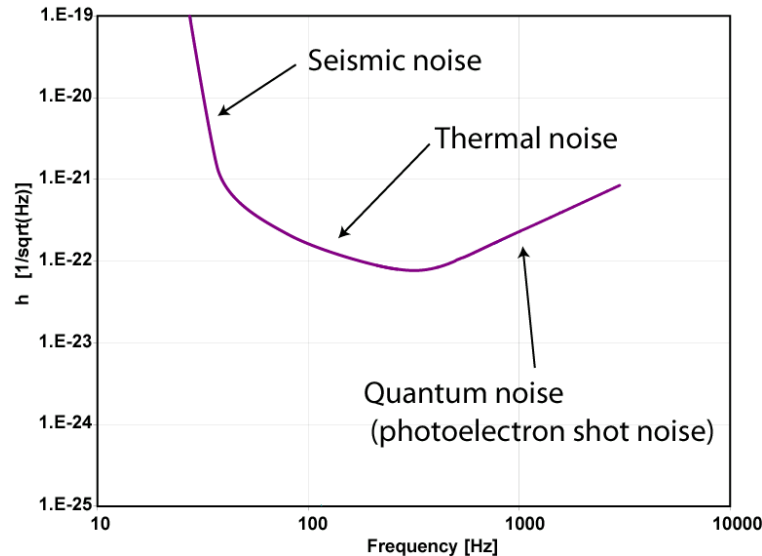

Multiple pendulum suspensions with low loss final stage

- **Isolation from seismic noise:**
 - Multiple pendulum suspensions, cantilever steel blades
e.g. GEO 600 triple pendulum suspensions (isolation $1/f^2$ per stage)
- **Minimise thermal noise:**
 - Make final stage of low loss material e.g. GEO 600

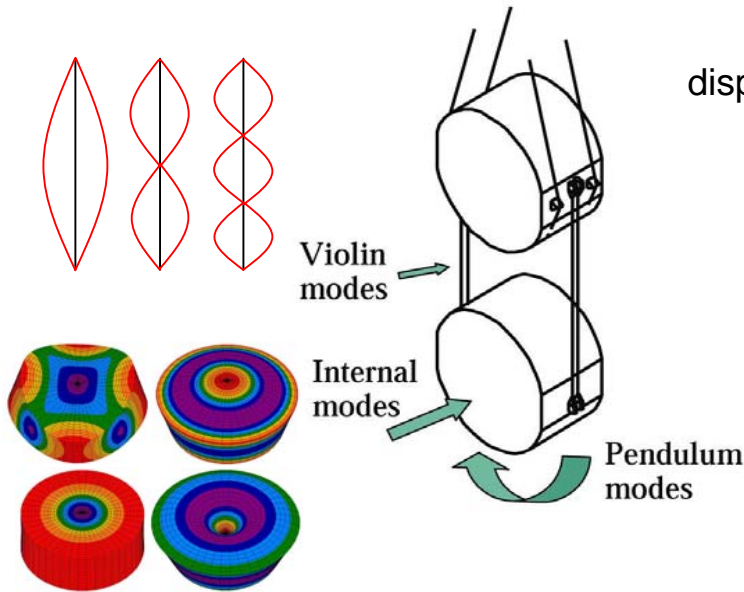

Each stage has pendulum, violin and test mass modes of vibration

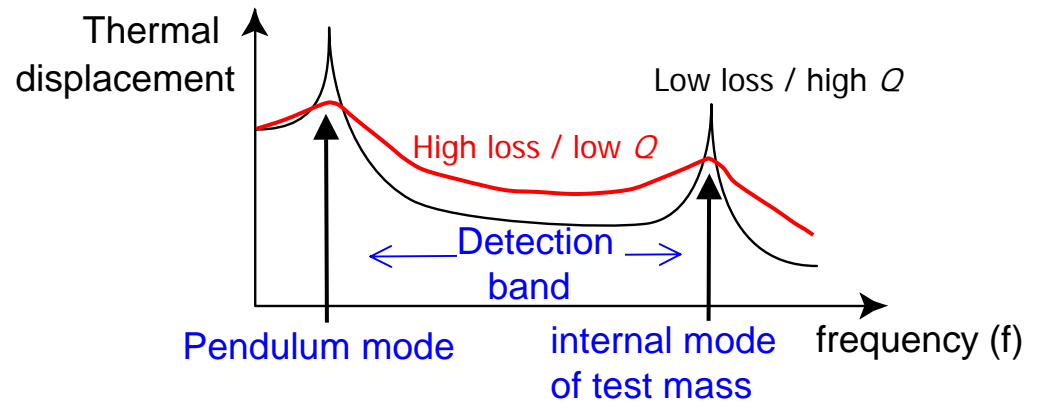

- *Quality Factor*, $Q = 1/\phi(\omega_0)$
- $\phi(\omega_0)$ is mechanical dissipation or loss
- want low $\phi(\omega_0)$, high Q

Unique GEO technology

- monolithic silica suspension for reduced thermal noise

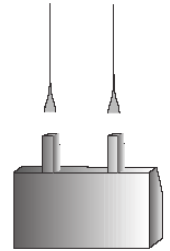
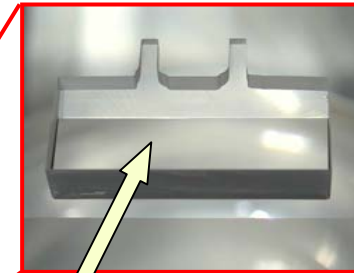
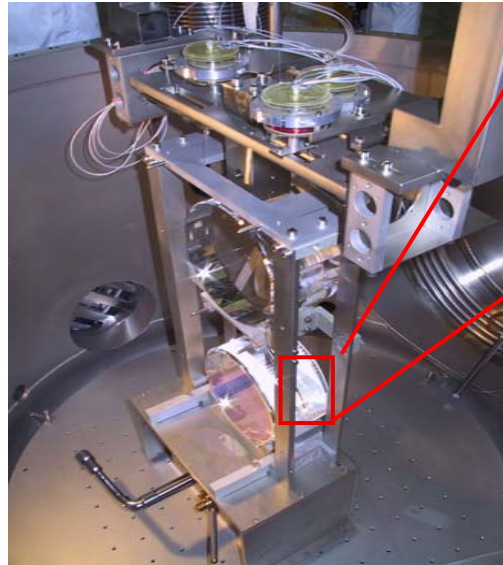
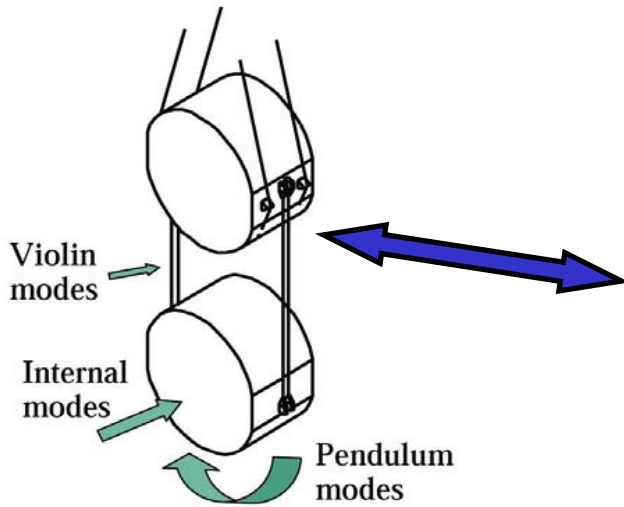

- 'Ears' are **silicate bonded** to silica mass.
- Silica fibres (circular cross-section) welded to silica ears
→ **low losses (high Q factors)**
→ **reduced thermal noise**

Dissipation due to bending of suspension fibres is 'diluted' by loss-less storage of energy. Hence pendulum and violin mode Q 's can be much higher than that of the material itself.

Monolithic silica suspension

- thermal noise reduction & practical considerations

■ Material

- $\phi_{\text{steel}} \sim 10^{-4}$; $\phi_{\text{silica}} \sim 3 \times 10^{-7}$ (losses reduced by $\sim \times 300$)
- $E_{\text{steel}} \sim 200 \text{ GPa}$; $E_{\text{silica}} \sim 70 \text{ GPa}$ (E reduced by $\sim \times 3$)

■ Geometry

- Use ribbons instead of circular fibres ($\sim \times 2.4$ increase in dilution factor for ribbon aspect ratio 10)

■ Monolithicity

- Will lead to reduced losses but difficult to quantify

■ Reduction in thermal noise:

- Circular fibres $> \times 23$; Ribbons $> \times 35$

■ Silica fibres - practical considerations

- Amorphous - can pull & weld
- High σ_b (up to 4 GPa) comparable to steel (3 GPa)
- But difficult to handle & install - surface defects
- Greater spread in σ_b
- Challenge to produce 'well-shaped' fibres and welds

GEO 600 silica suspension fibres - fabrication & welding technique

- Circular fibres pulled using oxy-hydrogen flame pulling machine. Manual flame welding.
- Successfully installed in GEO 600 late 2002.
- Limitations
 - Conductive/convective heating
 - Vaporisation of material on outer surface
 - Surface defects/contamination by combustion products can limit strength
 - Shape control - limited
 - Unsophisticated - melt and pull before silica cools down
 - Increased noise couplings, limited performance
 - Reproducibility - limited
 - Uniformity of cross sectional area at ~ 10% level in GEO 600

VIDEO CLIP OF FLAME PULLING OF RIBBON
by A. Heptonstall

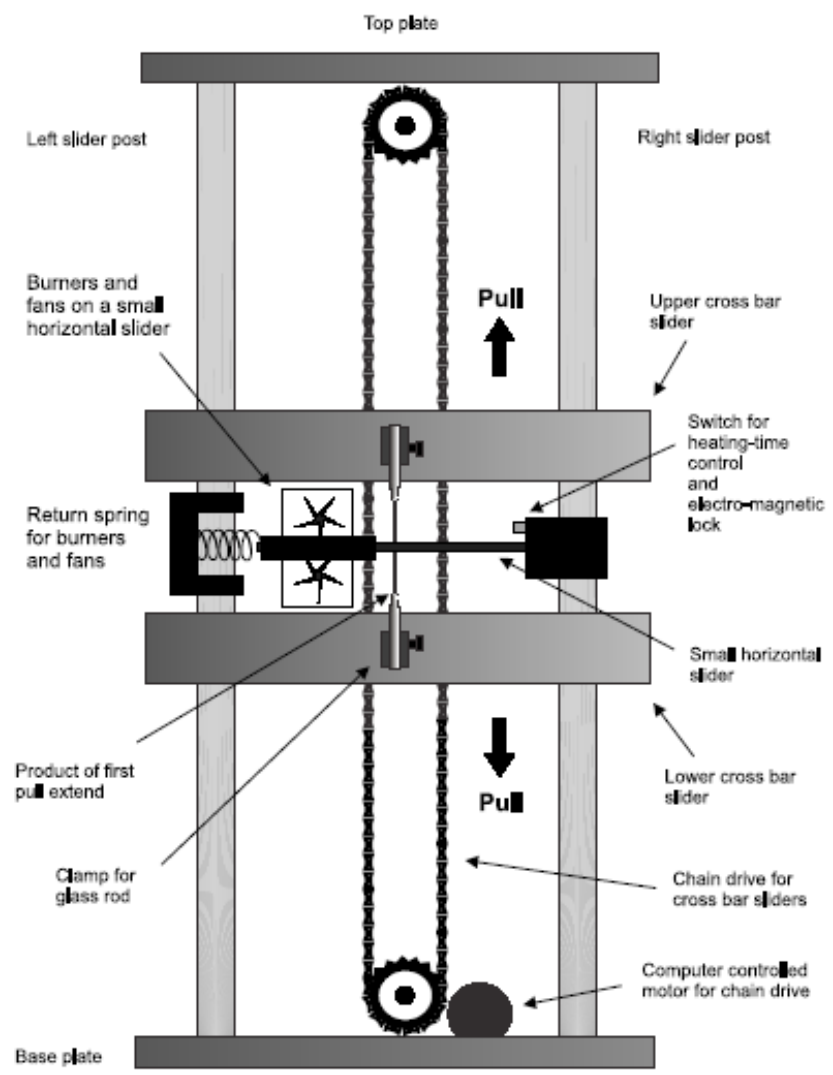

Improved silica fibre technology for advanced detectors

- Advanced detectors require **higher specification fibres** than GEO 600 - must push silica technology to the limit at **room temperatures**

e.g. Advanced LIGO baseline is to use **ribbons** (thinner, more compliant, higher dilution factors) or **dumbbell** fibres (cancellation of thermoelastic damping by strain). Dumbbell ribbons?

- Improvements to be made in:
 - Shape
 - Reproducibility
 - Surface quality
 - Level of contamination
 - Weld profile
- Use CO₂ laser machine for pulling & welding of fibres/ribbons
R & D already part funded by EGO organisation

CO₂ laser pulling & welding of silica fibres/ribbons

- Use CO₂ laser radiation (10.6 μm) to melt silica
- Potential advantages of laser fabrication & weld:
 - Controlled heating by absorption - reduced or no vaporisation on outer surface of material
 - Reduced contamination
 - Improved shape control by feed & pull (can also be done by flame)
 - Diameter self-regulation effect
 - Rapid energy control - fibre diameter feedback control possible
 - Precise spatial delivery
 - Re-correction of shape, stress relief/annealing afterwards
 - Precision welding - improved weld shape

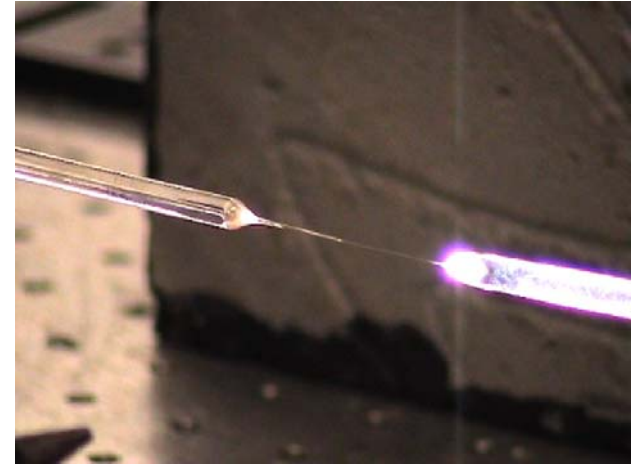

Diameter self-regulation

- Heat gained by absorption ($\propto \text{vol}$) balanced by heat lost by radiation ($\propto \text{area}$)
- As fibre is pulled the surface to volume ratio increases
- Material automatically cools as diameter decreases and pulling will cease
- For a given power of laser and constant axial tension should be able to reproduce fibres of identical diameter
- Question:
Can this effect be exploited for pulling our advanced fibres?

Absorption depth in fused silica at $\lambda = 10.6 \mu\text{m}$

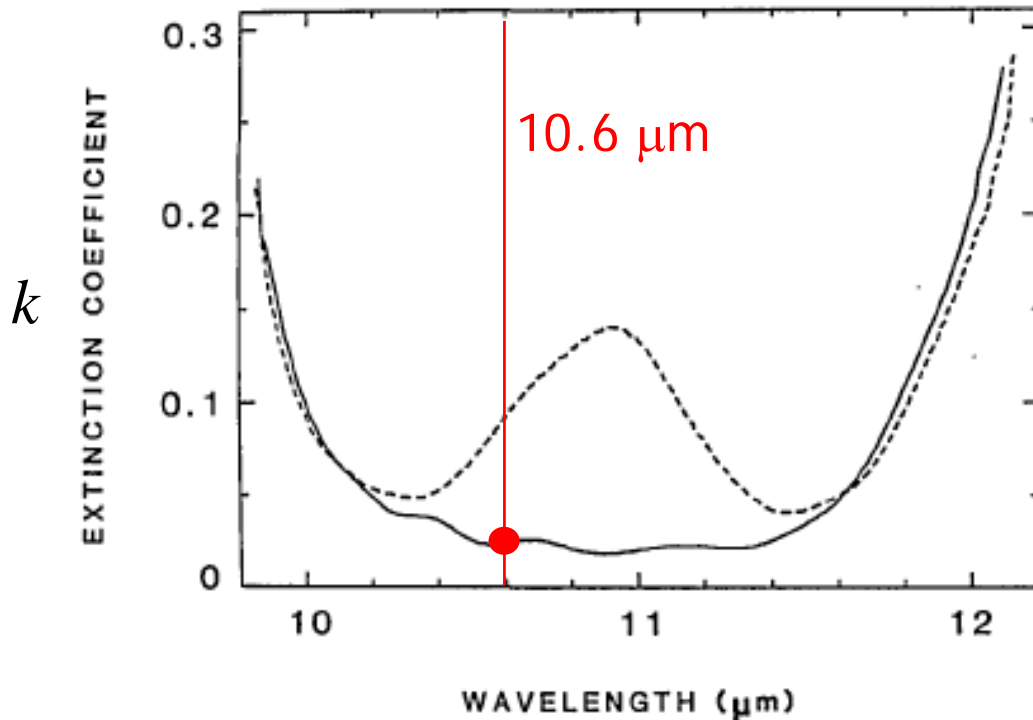

Fig. 3. Values of the extinction coefficient calculated from the data of Fig. 1: —, pure fused silica; ---, Vycor. The values were calculated from spectrophotometer transmittance measurements at 25°C.

(McLachlan & Meyer, Applied Optics, Vol 26 No. 9, 1987)

k = extinction (or attenuation) coefficient

n^* = complex index of refraction

$$n^* = n + ik$$

absorption depth β
(intensity reduced to 1/e)

$$\beta = \frac{\lambda}{4\pi k}$$

$$\beta = 34 \mu\text{m at } 25^\circ\text{C}$$

Diameter self-regulation: potential for exploitation?

- **Q:** Can this effect be exploited for our application?

e.g. Advanced LIGO ribbon dimensions
[600 mm x 1.12 mm x 112 μm]
- β only ~ 34 μm at 25°C for 10.6 μm (McLachlan & Meyer 1987)
- **A:** NO, dominated by surface heating without any substantial absorption of the radiation in the bulk of the material
- Applicable to manufacture of thinner fibres e.g. optical fibres, torsion balance fibres

VIDEO CLIP OF SELF-REGULATION by D. Crooks



Feed and Pull

- A key change proposed for advanced pulling process is to use 'feed and pull' technique (established technique).
- Silica stock is fed gradually into the laser beam while fibre is drawn out of the resulting melt. Final fibre diameter given by:
$$(v_1/v_2) = (d_1/d_2)^2$$
 with v , velocity and d , diameter
- Prototype manual machine has been constructed to test feasibility. Ratio $v_1/v_2 \sim 1/17$ so diameter of pulled fibre $\sim 1/4$ that of stock



VIDEO CLIP OF
MANUAL PULL

..... Crooks 2004
LIGO-G040433-00-K

Pulling machine conceptual design

Current conceptual design of cylindrical fibre machine

- fibre stock clamped to base of machine
- focus of laser (ring) moved downwards to progressively melt stock
- upper stock clamp moves upwards to draw fibre
- For ribbons jitter laser beam using 2-mirror galvanometer

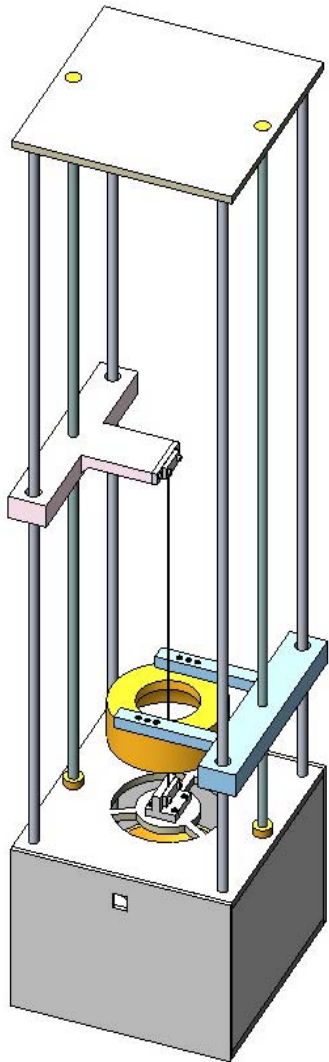

3D CAD representation

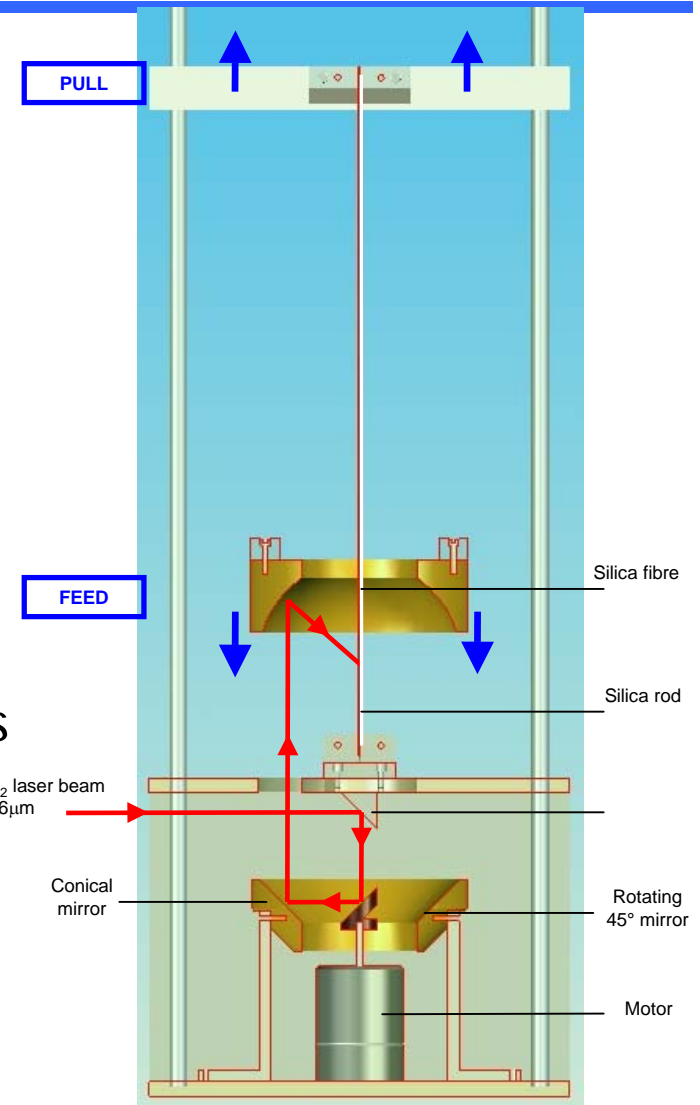

Concept Schematic

Welding with CO₂ laser radiation

- Proof of concept demonstrated using 1 mm rods.

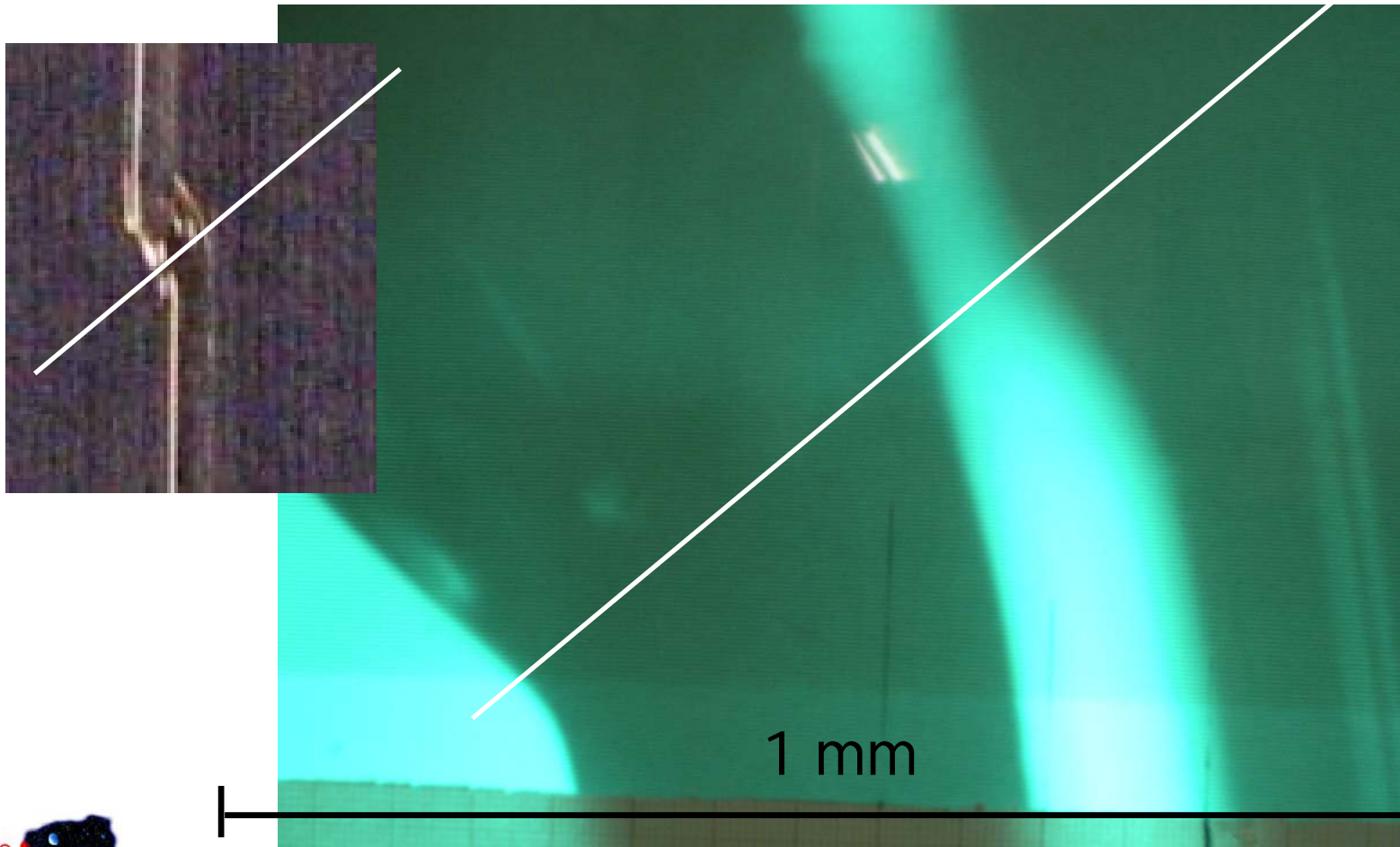

Weld
boundary

1 mm

Characterisation

- Require to characterise the pulled suspension elements:
 - Mechanical dissipation
 - Strength
 - Key resonant modes
- Need to develop technique to characterise shape of silica fibre/ribbon
 - Offline characterisation
 - Potential online control - use to control machine during pull process
- 3 possible methods
 - Edge detection (shadow sensors/microscope)
 - Refraction
 - Absorption profile

Profiling

- Edge detection

- Use either shadow sensor or camera picture to determine edges of element from which width and thickness can be determined. Gives overall dimensions but does not detect inner features.

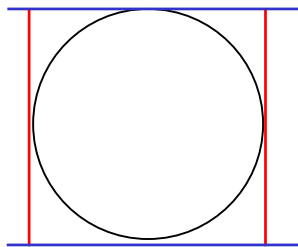

Fibre

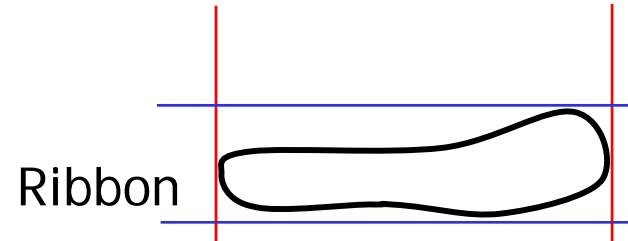

Ribbon

- Refraction

- Take reference image and use machine vision to determine thickness profile from refracted image

Profiling

- Absorption profile
 - Use low power CO₂ beam to scan across element and use absorption to determine thickness.

- We are currently investigating all methods but will focus on machine vision methods.

Preliminary CO₂ pulled fibre profile

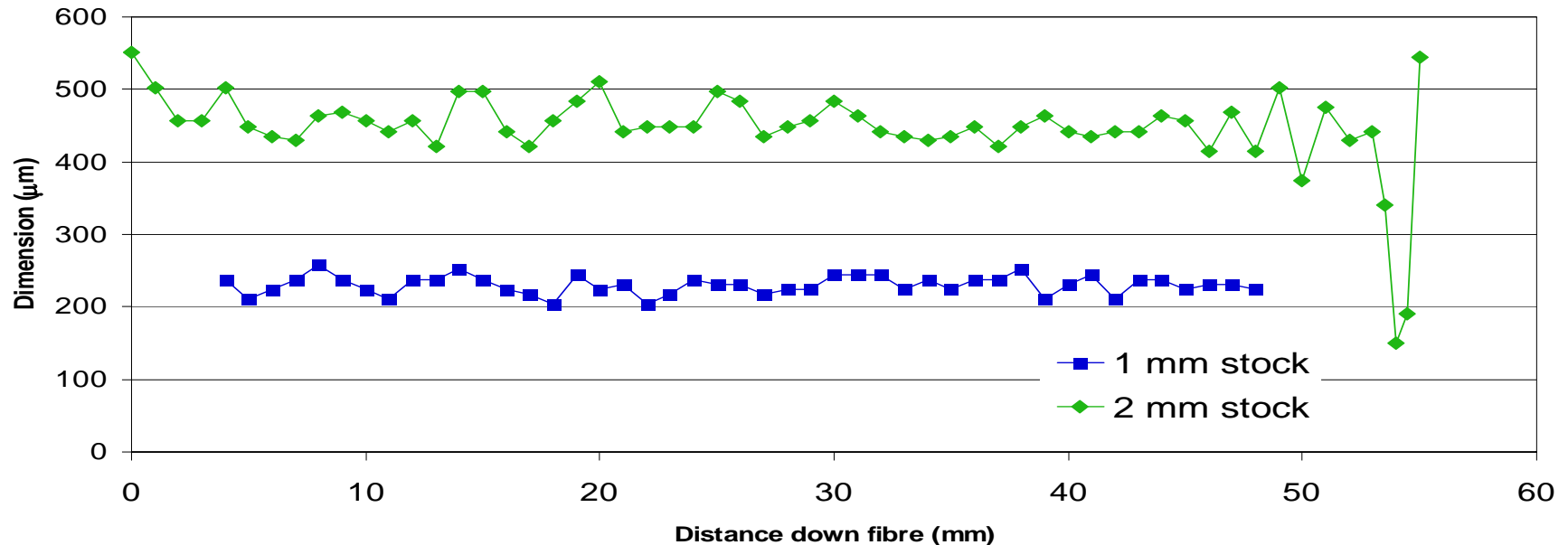

- Uniformity already of similar level between laser ($\pm 10\%$ around mean width along fibre) and flame drawn elements ($\pm 7\%$)
- Immediate improvements possible using
 - Motor drive
 - Power stabilisation

Planned work

- Power stabilisation of laser
- Further studies on the absorption of CO₂ laser radiation in silica
- Viscosity experiments
- Automate feed & pull machine/ adapt for ribbon use
- Develop fully automated welding technique
- Extend profiling methods
- Conceptual design complete by end of year