

Aspen Winter Conference 2005

Benefits of going underground

Sessions: Mon 2005-01-17, 16:30 – 19:30
Thu 2005-01-20, 18:10 – 19:30
Fri 2005-01-21, 09:40 – 10:50



Session: Benefits of Going Underground I

Mon, January 17

- | | | |
|-------|-------------------------|--------------------------------------|
| 16:30 | Eugenio Coccia | Activities at Gran Sasso Underground |
| 16:55 | Discussion | Laboratory |
| 17:05 | Albrecht Rüdiger | Underground detector configurations: |
| 17:30 | Discussion | simple, sufficient, redundant, cheap |
| 17:40 | break | |
| 18:10 | Riccardo DeSalvo | Mining considerations |
| 18:35 | Discussion | |
| 18:45 | Rosario DeRosa | Seismic noise coherence measurements |
| 19:20 | Discussion | in deep salt mines |
| 19:30 | Adjourn | |



Session: Benefits of Going Underground II

Thu, January 20 (second afternoon session)

after LISA session (16:30 – 17:40)

18:10 **Nobuaki Sato** Underground interferometers in Japan

18:45 Discussion

18:55 **Riccardo DeSalvo** Seismic attenuation from LIGO to CEGO,
19:20 Discussion and back

19:30 Adjourn



Session: Benefits of Going Underground III

Fri, January 21 (second morning session)

after session on Science runs (8:00 – 9:10)

09:40 Riccardo DeSalvo

and A. Cacciani:

Strange things you can do with
underground GW detectors

10:05 Discussion

10:15 TBD

TBA

10:40 Discussion

10:50 Adjourn



Underground Detector Configurations: simple, sufficient, redundant, cheap

Albrecht Rüdiger, Albert-Einstein-Institut
albrecht.ruediger@aei.mpg.de



- Presumptuous title and subtitle:
will have to explain that later,
literally **word** by **word**
- Underground detector configurations:
will become the topic of discussions
with **Riccardo DeSalvo** and **all of you**



Underground Detector Configurations: simple, sufficient, redundant, cheap

- **Underground:**

very quiet, constant, benign environment,
heard about that in **Eugenio's** talk, and it
will be topic of some of the following talks

Particularly well suited: **salt mines**

in 1990 had contacted **Kali und Salz**

will hear more about that from **Riccardo**



Underground Detector Configurations: simple, sufficient, redundant, cheap

simple:

Simplest is a **single** interferometer, but
optimized for only one polarization

Typical shape:
orthogonal

Typical size:
3 to 5 km

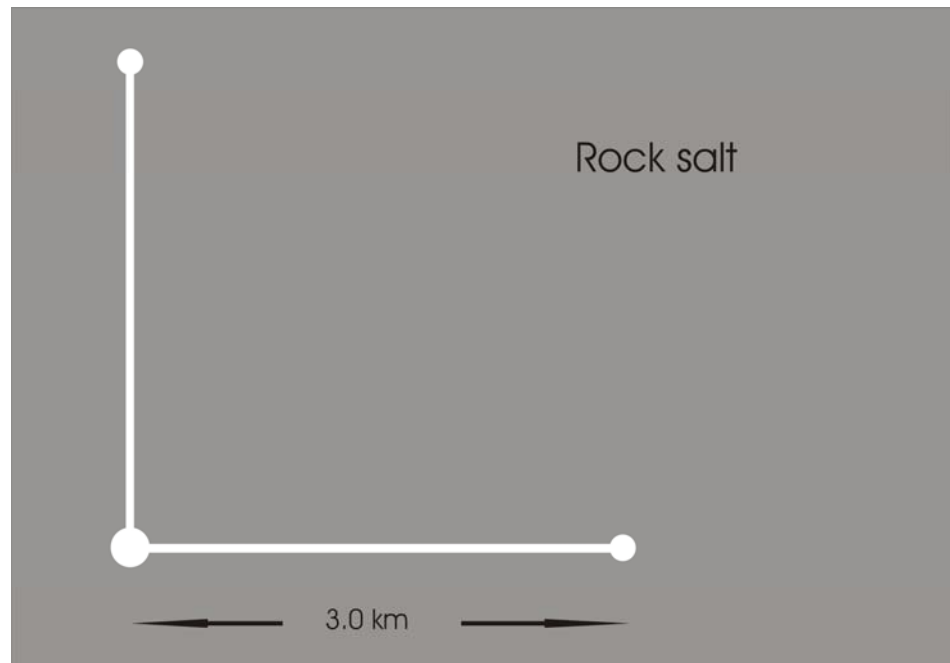

Underground Detector Configurations: simple, sufficient, redundant, cheap

sufficient:

have (at least) **two** interferometers
to see **both** polarizations

Possible
configuration:

angle 45°

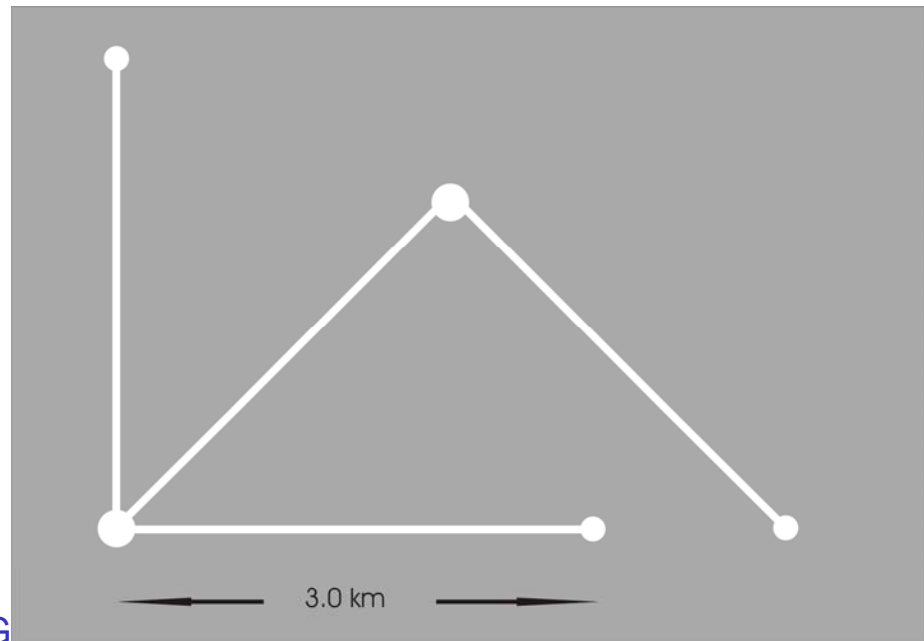

Underground Detector Configurations: simple, sufficient, **redundant**, cheap

redundant :

Have three interferometers:

catch **both polarizations**, + **redundancy**

Possible shape:
at 30° each

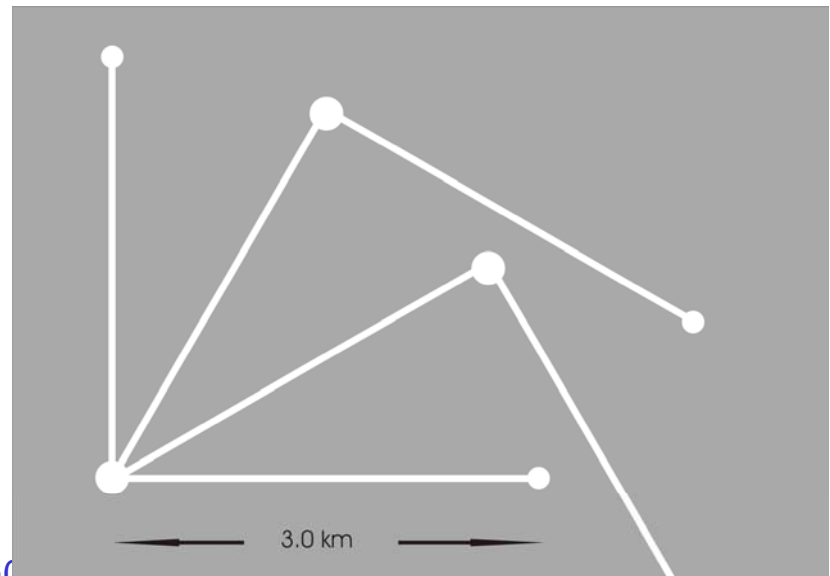

LIGO-GO



Underground Detector Configurations: simple, sufficient, redundant, cheap

not cheap : (in space required):

These configurations wasteful with space:

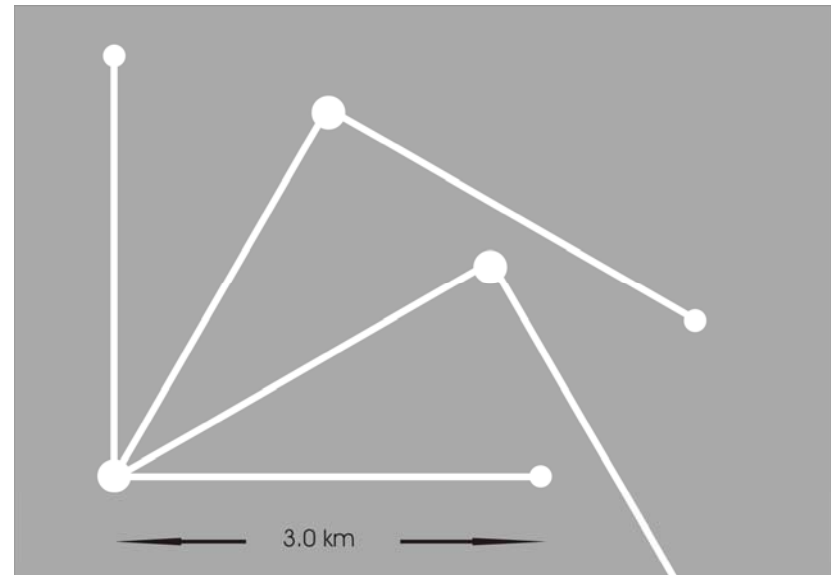
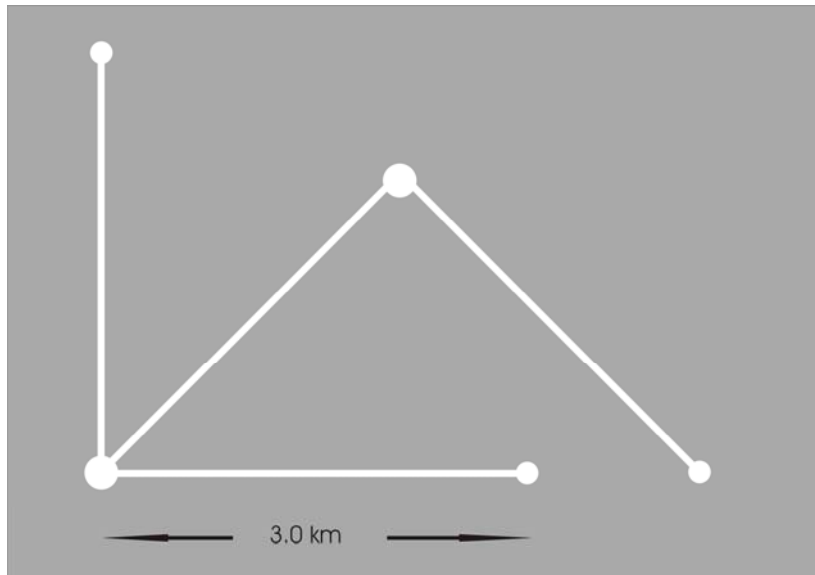

Underground Detector Configurations: simple, sufficient, redundant, cheap

not cheap : (in space required):

Even more wasteful with space:



Underground Detector Configurations: simple, sufficient, redundant, cheap

not cheap : (in excavating tunnels):

These configurations wasteful with
tunnels:

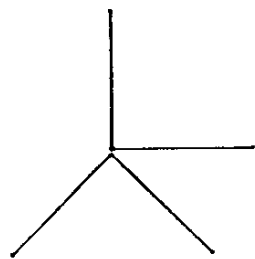

(a)

sufficient

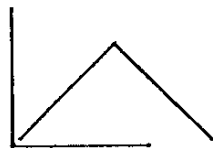

(b)

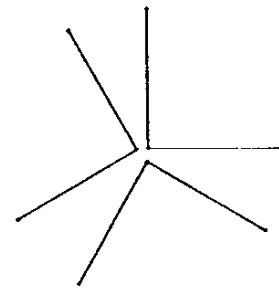

(c)

redundant

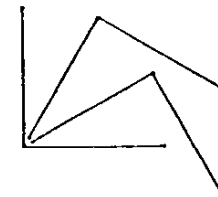

(d)



Underground Detector Configurations: simple, sufficient, redundant, cheap

cheap : (saving space and tunnels):

Triangular configuration (proposed 1987):

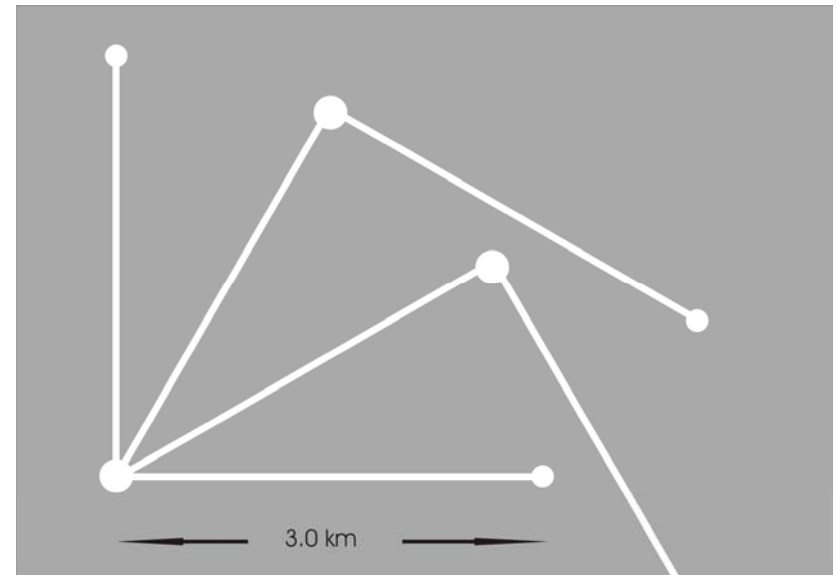
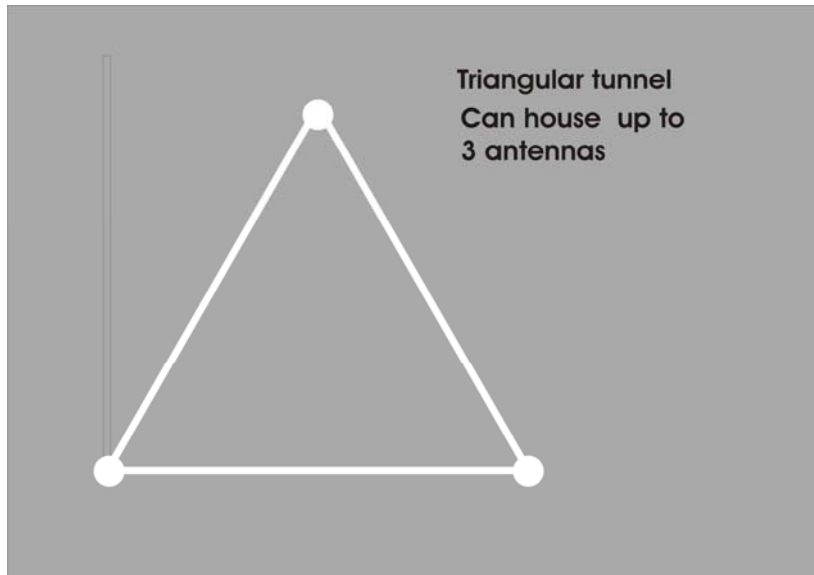

The price: **loss in response** by 13.4 %



Underground Detector Configurations: simple, sufficient, redundant, cheap



Comparison of configurations

		Rechtwinklige Interferometer				Dreieck	
		vollständig		redundant		vollst.	redund.
Zahl der Tunnel	T	4	4	6	6	3	
Zahl der Häuser	H	5	5	7	7	3	
Durchmesser Umkreis	D/l	2,0	1,7	2,0	1,9	1,1	
Fläche Polygon	F/l ²	1,71	0,75	2,25	1,25	0,43	
G.W.-Signal	s/s _{max}	1,00	1,00	1,00	1,00	0,866	

Tabelle 3.II: Vergleich von "vollständigen" und "redundanten" Konfigurationen aus rechtwinkligen Interferometern mit einer Dreiecks-Konfiguration aus 60°-Interferometern.

Underground Detector Configurations: simple, sufficient, redundant, cheap

Detector Configurations:

Using triangular configuration,

Separate vacuum housings

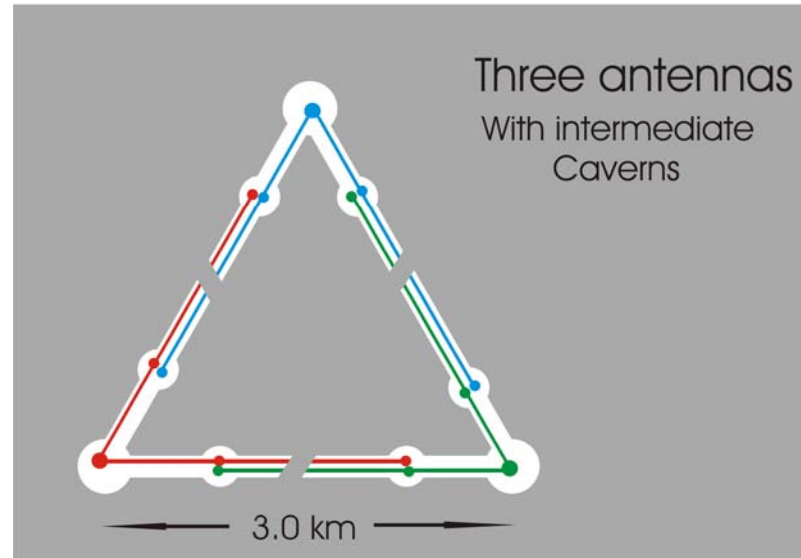
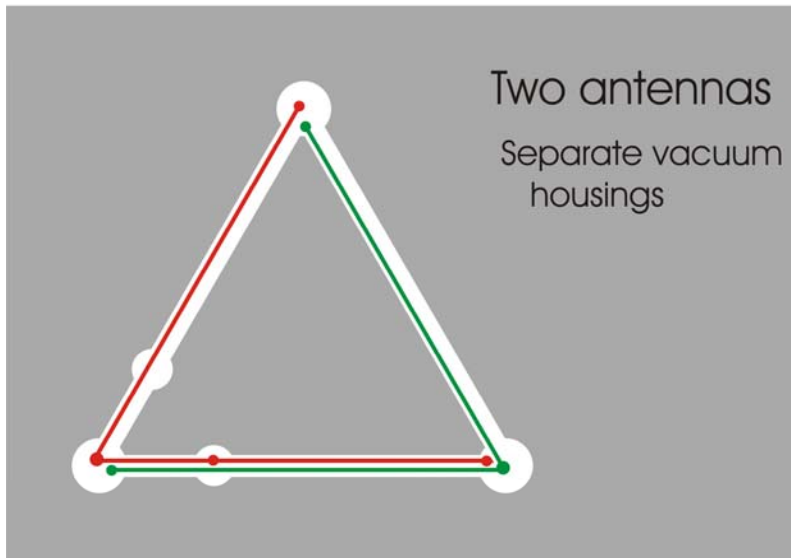

Underground Detector Configurations: simple, sufficient, redundant, cheap

cheap : (saving space and tunnels):

The price: **loss in response** by 13.4 %

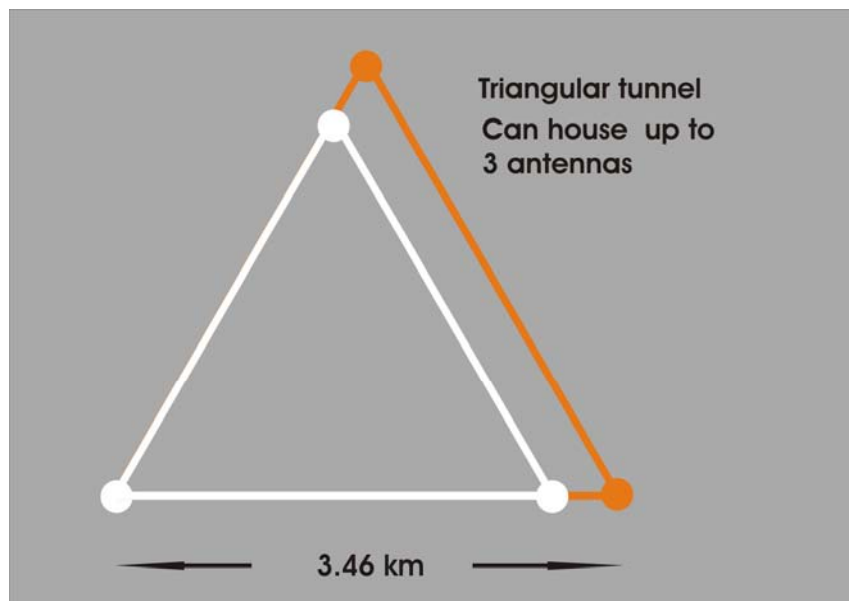

make arms **longer** ??
e.g. by these 13.4 %
($3 \times 3.46 < 4 \times 3 \text{ km}$)
(for lower frequencies)

Underground Detector Configurations: simple, sufficient, redundant, cheap

Detector Configurations:

Using triangular configuration,

Separate vacuum housings

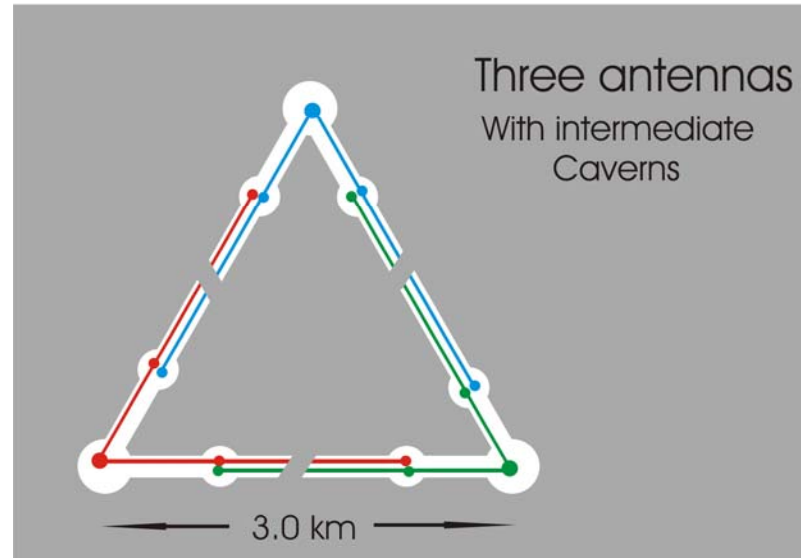
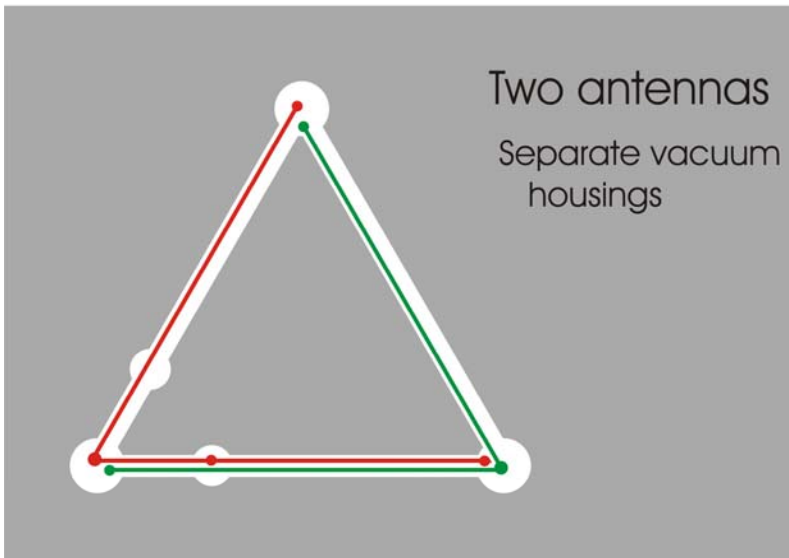

Underground Detector Configurations: simple, sufficient, redundant, cheap

Cheap ?

Using triangular configuration,
with separate vacuum housings:

No savings in tubes:
also need 3 x 2 tubes

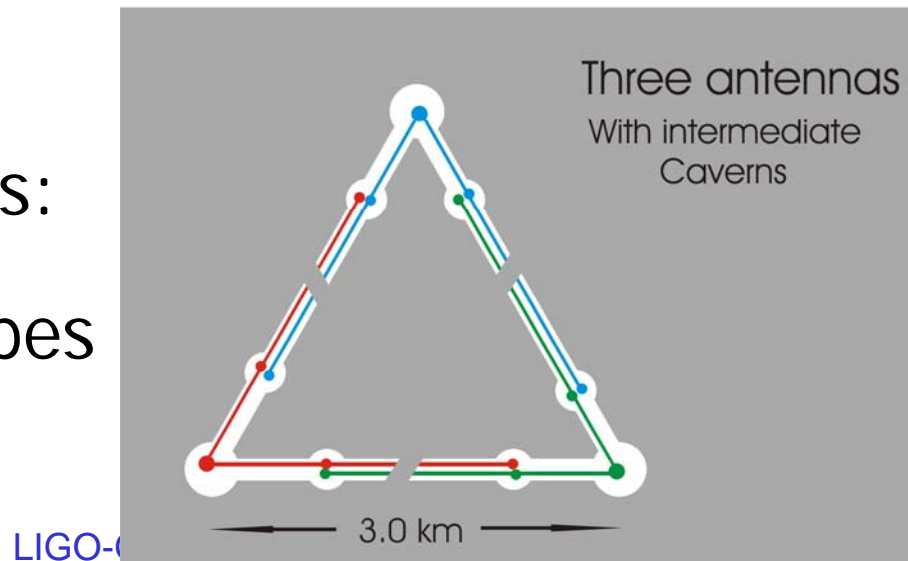

Underground Detector Configurations: simple, sufficient, redundant, cheap

Detector Configurations:

Multiple arms accommodated in tunnel:
separate vacuum housings

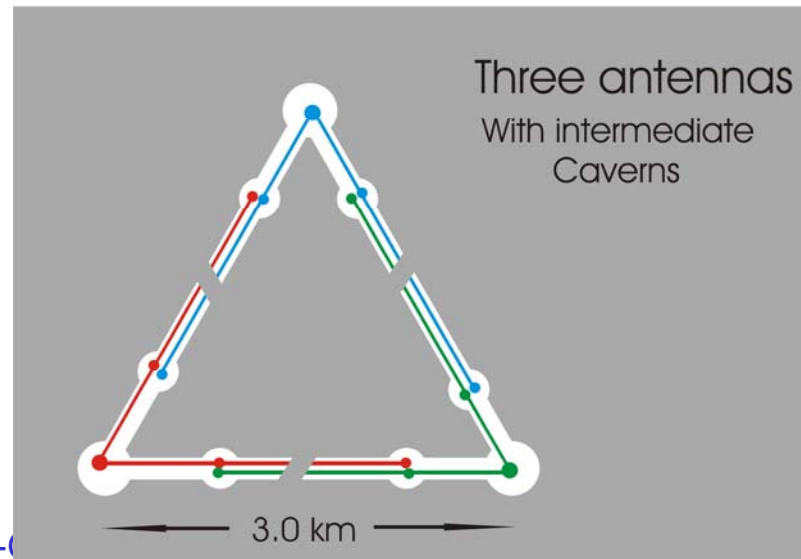
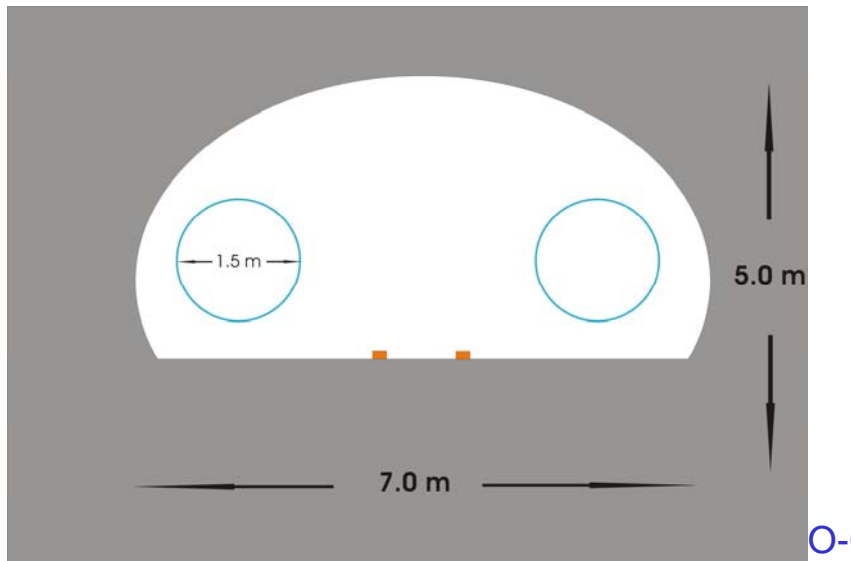

Underground Detector Configurations: simple, sufficient, redundant, cheap

Detector Configurations:

Plenty of room in tunnels (Riccardo):
transport pipes on rails, on beam (GEO)

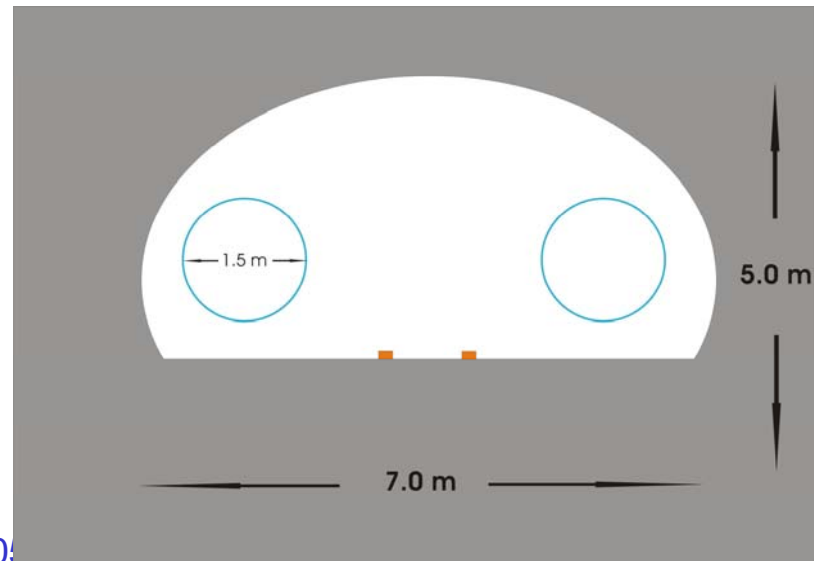
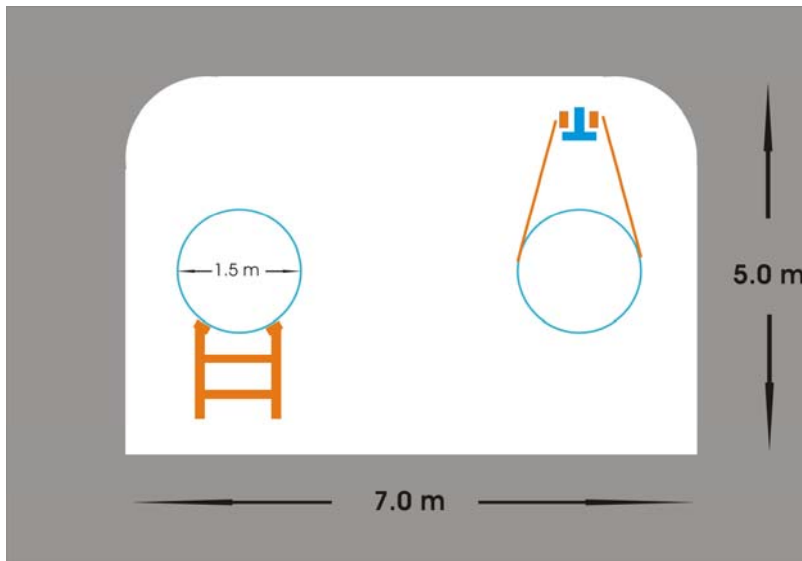

GO.



Underground Detector Configurations: simple, sufficient, redundant, cheap

cheap:

Cut cost of pipe

In 1990s, GEO proposed **corrugated pipes**

Investigations at RAL, UK (**R. Bennett**)

Cost of stainless steel dominant

1.2 m tubes tested, successful

Such tubes later used for GEO 600



Underground Detector Configurations: simple, sufficient, redundant, cheap

cheap:

Cut cost of pipes:

GEO used **corrugated pipes**



LIGO-G050026-00-Z

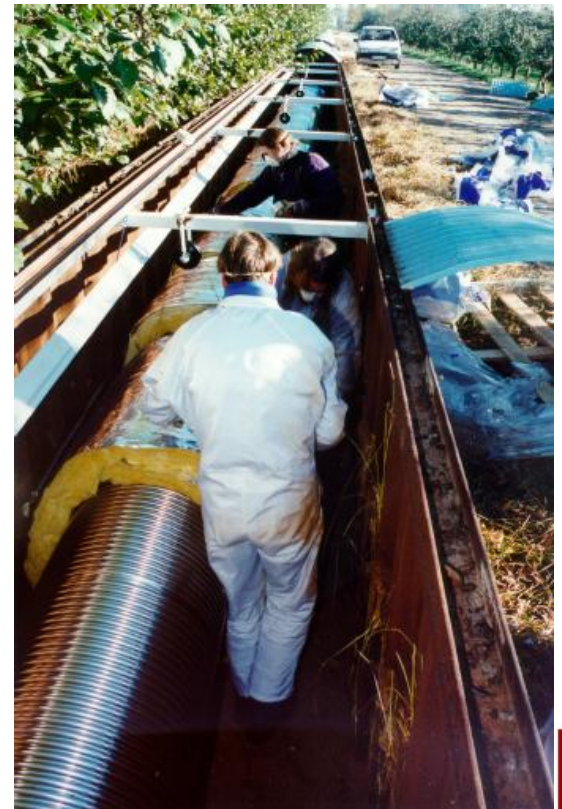

Underground Detector Configurations: simple, sufficient, redundant, cheap

Underground, in rock salt sites

multi-detector configurations

accommodated in triangular tunnel

corrugated tubes

