***Science
and
Integration Meeting***

***Barry Barish
May 22, 1997***



LIGO-G970080-00-M

LIGO

general

- PAC (B. Frazer, chair)
 - » 1st meeting (Caltech/Jan '97)
 - formation - LIGO Lab and Scientific Collaboration
 - proposals for advanced r & d for LIGO
 - » 2nd meeting (MIT/June '97)
 - formation - LIGO Lab and Scientific Collaboration
 - data analysis and computing
 - LIGO program and plans at MIT

- MIT/Caltech Oversight Committee
 - » met April '97 - formation of LIGO Laboratory
 - » met May '97 - NSF review report

- Formation of the LIGO Scientific Collaboration (LSC)
 - » development groups
 - LIGO I : initial two year physics run (begin 2002)
 - advanced r & d development groups
 - analysis group ??
 - » MOU/attachments - kickoff mtg at LSU (~Aug)



Technical Status

facilities

- Hanford Construction (on schedule)
 - » foundation and slab - complete
 - » x arm beam tube, enclosure - complete
 - » y arm beam tube - beginning
 - » buildings under construction
- Louisiana Construction (on schedule)
 - » berm complete, being stabilized
 - » differential settling is OK
 - » poured first concrete
- Technical Status
 - » beam tube dimensions, welding, survey meet specifications.
 - » no leaks found on 65 ft sections or girth welds
 - » full 2 km x arm module pumpdown successful
 - » bakeout technical plan and schedule
 - » baffles solution being implemented

Technical Status

detector

- Management and Status
 - » all task leaders in place and subsystems are nearly fully staffed
 - » most subsystems in design phase (50% in preliminary design and 50% in final design)
- Detector focus
 - » Laser development at Lightwave and prestablization at Caltech
 - » Core Optics (*note NSF review*)
 - » Input Optics (*note NSF review*)
 - » Seismic Isolation
 - » Length and Alignment Sensing

Technical Status

data and computing

- Data Analysis System (DAS) for LIGO I
 - » White Paper
 - » primary focus of PAC2 @ MIT in June
- Detector Diagnostics (Weiss)
- Data formats - frames (Blackburn)
- Data Processing (Allen)
 - » GRASP package; 40 m studies
- 40m prototype data run (Ware)
 - » demo of DAQ system
- End to End Modeling (Rahmin, Evans)
 - » 40m - validation, PSL

Status

Advanced R & D

- Transition Period
 - » LIGO I detector R&D - recycling, then ?
 - » Advanced R&D program begins In 1997
- Advanced R&D Program
 - » initiate during 1997 (\$0.9M)
 - » LIGO Lab multiyear proposal due October '97
- Items for discussion at this meeting
 - » proposal for research facility upgrade (MIT)
 - » future of the 40m (Caltech)
 - » table top: signal recycling (Florida)
 - » table top: resonant sideband extraction(Caltech)

This Meeting

prime objectives

- White paper and related data issues
 - » focus of PAC2 with added experts

- Advanced R&D program
 - » MIT plans will be presented to PAC2

- LIGO Scientific Collaboration Issues
 - » structure of LIGO Laboratory
 - » structure and governance of LSC
 - » relation of LSC to LIGO Laboratory
 - » organization of LIGO I
 - » spokesman ?
 - » organization of development groups and LIGO Labs role

From: Stan Whitcomb
Date: Tue May 20 15:03 PDT 1997
To: cit-all@ligo.caltech.edu, mit-all@ligo.caltech.edu, reitze@phys.ufl.edu
Subject: Nearly Final Agenda for Science and Integration meeting

The next Science and Integration meeting will be held May 22-23. The following is the nearly final agenda. I have tried to incorporate all suggestions and changes. Please let me know if there are any problems.

stan

Copies ordered 6/9

Nearly Final Agenda for Science and Integration meeting

Thursday May 22

9:00 am

Announcements and questions

~~Barish (30 min)~~

VGS

✓

Beamtube Pumpdown report

~~Weiss (20 min)~~

VGS ✓

Automatic system identification and adaptive control approaches for interferometers

~~Goyne (30 min)~~

✓

An integrated approach to detector diagnostics

~~Weiss (20 min)~~

VGS ✓

40m End-to-End Model

- 1) Construction of a Simplified PSL
- 2) Digital Filters with examples

~~Evans (20 min)~~

~~Rahman (20 min)~~

need VGS

On-line document search and retrieval demonstration

~~Althouse (30 min)~~

no documents

lunch

Data Analysis/Computing needs for LIGO

White paper summary

~~Lazzarini (30 min)~~

What have we learned about frames?

~~Blackburn (30 min)~~

GRASP

~~Allen (30 min)~~

40 m data acquisition run

~~Ware (20 min)~~

Demonstration of 40 m DAQ system

~~Ware, Bork, Raab (rest of the day)~~

Friday May 23

9:00 am

Advanced R&D plans and discussion

Introduction to issues for this meeting ~~Sanders (5 min)~~

Signal recycling / table top
RSE / table top
Discussion

Reitze (15 min)

~~Mason (15 min)~~

(15 min)

need

Seismic/Suspension/Thermal Noise Working
Group Plans and MIT group plans
Discussion

~~Shoemaker (20 min)~~

(15 min)

MIT Group Transition and Research
Facility Upgrade
Discussion

Zucker (20 min)

(15 min)

need

Caltech - 40 Meter Intermediate Term
Options

~~Colès (20 min)~~

need

Caltech - 40 Meter Longer Term Options
Discussion

~~Kawamura et al. (20 min)~~

(20 min)

need

lunch

Thermal lensing in the core optics

Results from the FFT model

Contamination test status

Discussion

Kells (30 min)

need

~~Shoemaker/Camp (30 min)~~

~~All (60 min)~~

Possible elimination of some HAM seismic
isolation stacks

Background and questions

~~Whitcomb (20 min)~~

Discussion

~~All (60 min)~~

DISTRIBUTION:

B. Allen
W. Althouse
B. Barish
D. Barker
K. Blackburn
J. Camp
M. Coles
D. Coyne
D. Durance
M. Fine
R. Gustafson
S. Kawamura
W. Kells
A. Lazzarini
W. Lee
K. Libbrecht
P. Lindquist
J. Logan
W. Majid
N. Mavalvala
S. Meshkov
T. Prince
F. Raab
G. Sanders
R. Savage
S. Seel
L. Sievers
M. Smith
R. Spero
K. Thorne
R. Vogt
B. Ware
S. Whitcomb
H. Yamamoto
MIT-Science
Chronological File *
Document Control Center

Science and Integration Meeting at Caltech May 22-23, 1997

LIGO-G970162-00-D



***Science
and
Integration Meeting***

***Barry Barish
May 22, 1997***



LIGO

general

- PAC (B. Frazer, chair)
 - » 1st meeting (Caltech/Jan 97)
 - formation - LIGO Lab and Scientific Collaboration
 - proposals for advanced r & d for LIGO
 - » 2nd meeting (MIT/June 97)
 - formation - LIGO Lab and Scientific Collaboration
 - data analysis and computing
 - LIGO program and plans at MIT

- MIT/Caltech Oversight Committee
 - » met April 97 - formation of LIGO Laboratory
 - » met May 97 - NSF review report

- Formation of the LIGO Scientific Collaboration (LSC)
 - » development groups
 - LIGO I : initial two year physics run (begin 2002)
 - advanced r & d development groups
 - analysis group ??
 - » MOU/attachments - kickoff mtg at LSU (~Aug)



Technical Status

facilities

- Hanford Construction (on schedule)
 - » foundation and slab - complete
 - » x arm beam tube, enclosure - complete
 - » y arm beam tube - beginning
 - » buildings under construction
- Louisiana Construction (on schedule)
 - » berm complete, being stabilized
 - » differential settling is OK
 - » poured first concrete
- Technical Status
 - » beam tube dimensions, welding, survey meet specifications.
 - » no leaks found on 65 ft sections or girth welds
 - » full 2 km x arm module pumpdown successful
 - » bakeout technical plan and schedule
 - » baffles solution being implemented

Technical Status

detector

- Management and Status
 - » all task leaders in place and subsystems are nearly fully staffed
 - » most subsystems in design phase (50% in preliminary design and 50% in final design)

- Detector focus
 - » Laser development at Lightwave and prestablization at Caltech
 - » Core Optics (*note NSF review*)
 - » Input Optics (*note NSF review*)
 - » Seismic Isolation
 - » Length and Alignment Sensing

Technical Status

data and computing

- Data Analysis System (DAS) for LIGO I
 - » White Paper
 - » primary focus of PAC2 @ MIT in June
- Detector Diagnostics (Weiss)
- Data formats - frames (Blackburn)
- Data Processing (Allen)
 - » GRASP package; 40 m studies
- 40m prototype data run (Ware)
 - » demo of DAQ system
- End to End Modeling (Rahmin, Evans)
 - » 40m - validation, PSL

Status

Advanced R & D

- Transition Period
 - » LIGO I detector R&D - recycling, then ?
 - » Advanced R&D program begins In 1997
- Advanced R&D Program
 - » initiate during 1997 (\$0.9M)
 - » LIGO Lab multiyear proposal due October '97
- Items for discussion at this meeting
 - » proposal for research facility upgrade (MIT)
 - » future of the 40m (Caltech)
 - » table top: signal recycling (Florida)
 - » table top: resonant sideband extraction(Caltech)

This Meeting

prime objectives

- White paper and related data issues
 - » focus of PAC2 with added experts
- Advanced R&D program
 - » MIT plans will be presented to PAC2
- LIGO Scientific Collaboration Issues
 - » structure of LIGO Laboratory
 - » structure and governance of LSC
 - » relation of LSC to LIGO Laboratory
 - » organization of LIGO I
 - » spokesman ?
 - » organization of development groups and LIGO Labs role

Beamtube Pumpdown

R. Weiss



SCHEMATIC OF MODULE

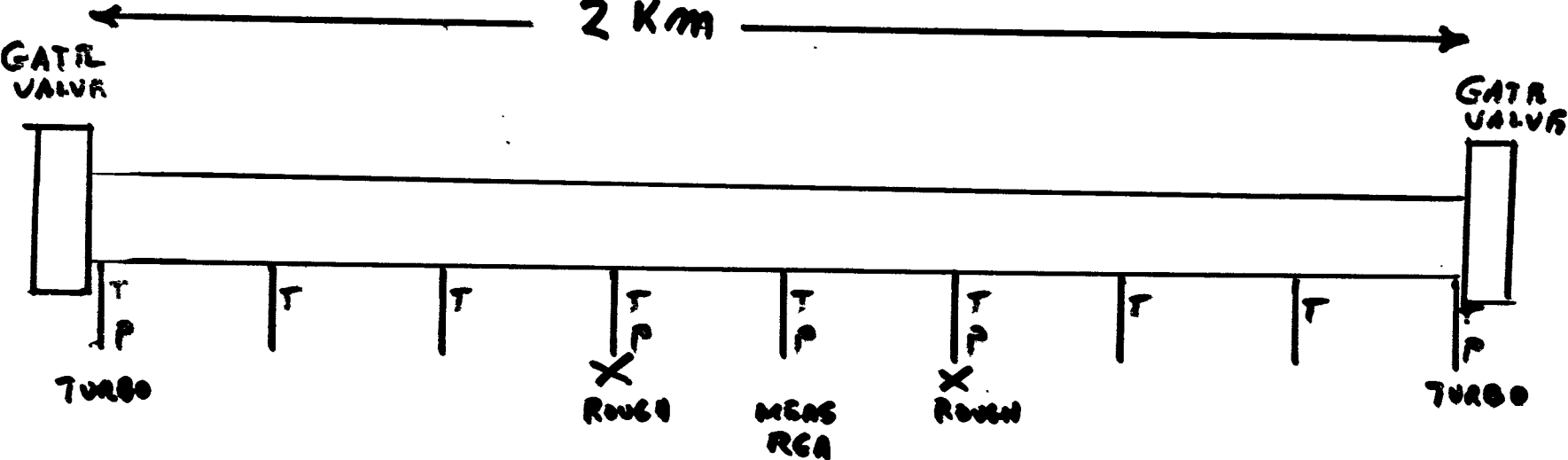

CBI

IDENTIFICATION
ACCEPT

TITLE MODULE AIR SIGNATURE
ACCEPTANCE TEST
PROCEDURE

PRODUCT LIGO BEAM TUBE MODULES
CALIFORNIA INSTITUTE OF TECHNOLOGY

REFERENCE NO. 953571		SHT 419 OF 14	
OFFICE LIGO		REVISION 2ED	
MADE BY WAC	CHKD BY MLT	MADE BY WAC	CHKD BY MLT
DATE 9/23/96	DATE 9/23/96	DATE 54/1247 /97	DATE 4/17/97

TYPE "B" PUMP PORT HARDWARE

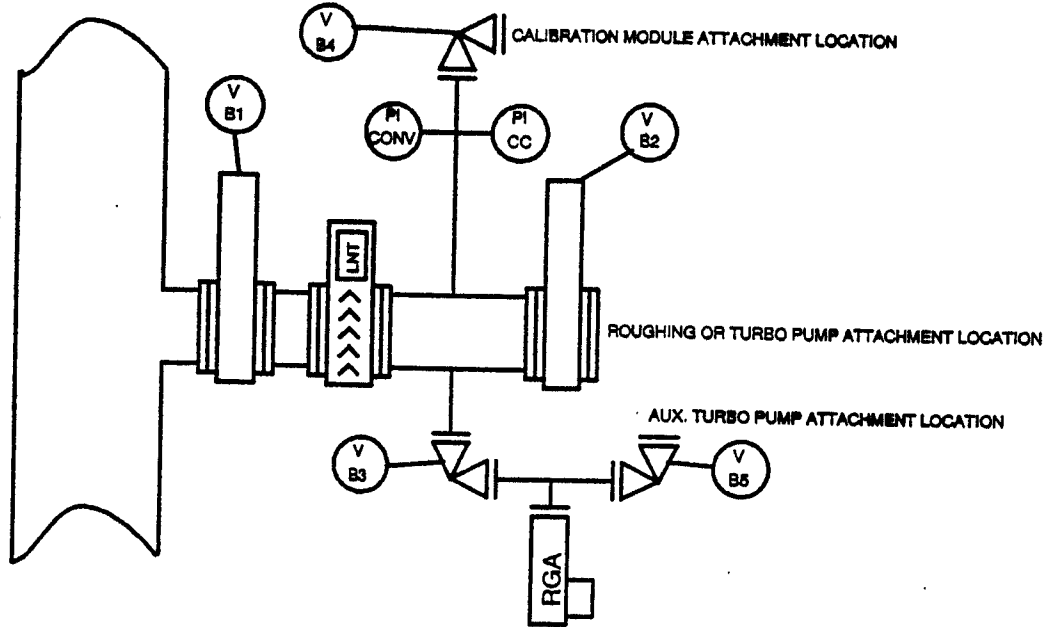

PUMP PORT HARDWARE CALIBRATION MODULE

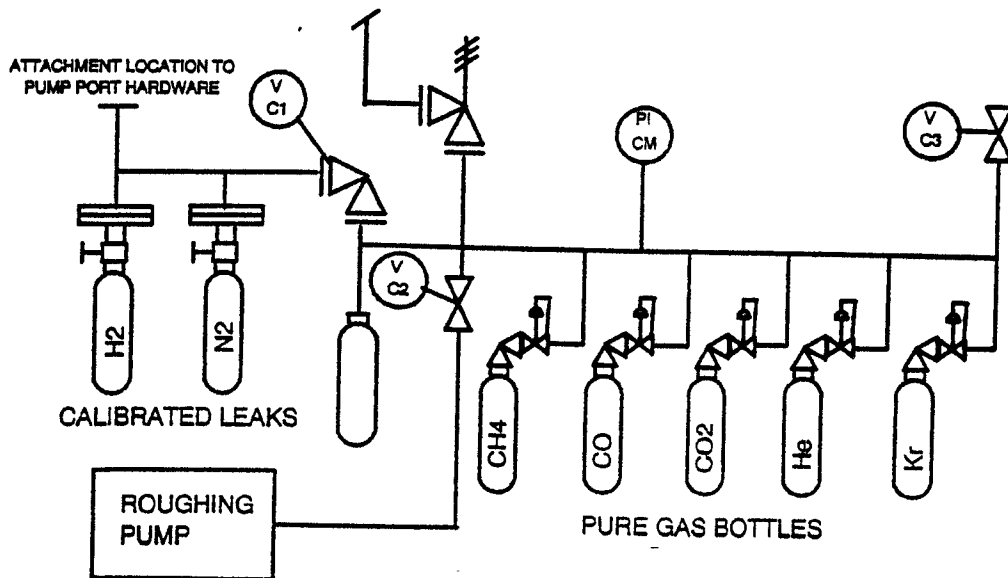

Table 1: Beam Tube Parameters

Volume of a 2km module	2.42×10^6 liters
Area of a 2km module	7.8×10^7 cm ²
Number of pump ports	9
Nominal spacing of the pump ports	250 meters
Pump port aperture (ID)	25.4 cm
Pump port length	6.4 cm

Table 2: Pumping system geometric parameters

Total length of 10 inch tubing from tube to turbo pump	161 cm
Total length of 10 inch tubing from tube to LN ₂ trap	45 cm
Total length of 10 inch tubing from tube to roughing pump	117 cm
Total length of 6 inch tubing in roughing line	97 cm

Table 3: Turbo pump characteristics: Edwards STPH 2000C

<i>gas</i>	<i>cat. pumping speed</i>	<i>compression</i>	$\alpha 1/(\sqrt{\text{amu}})$	<i>meas.pumpingspeed</i>
N ₂	2000 liters/sec	$> 10^8$	> 3.48	1100 to 1300 liters/sec
H ₂	1600	10^3	4.89	
He	1800	10^4	4.60	

Pressure History, Module HAX2

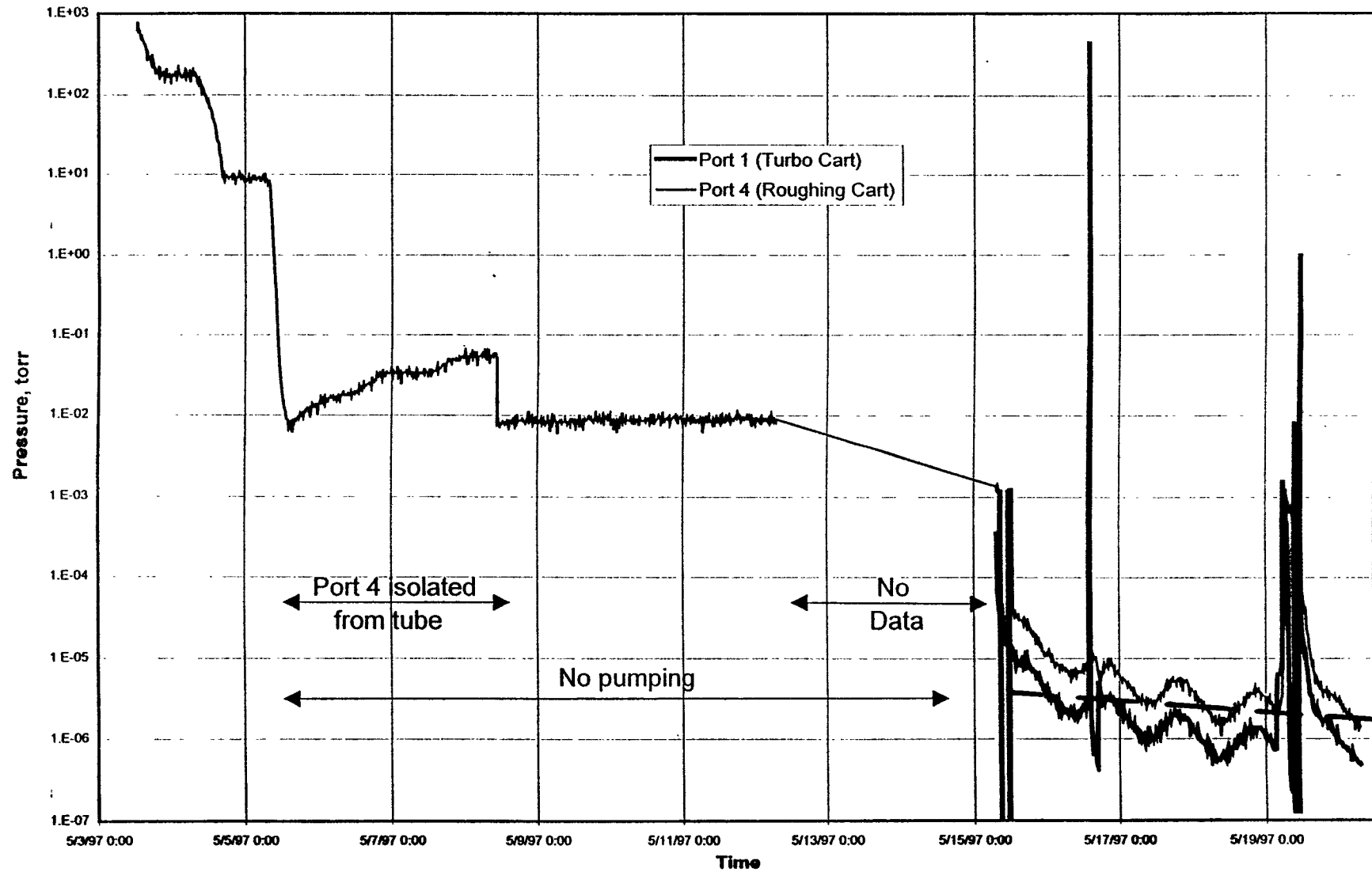

9T
H₂O

Tube Temperature, HAX2 Module Ends

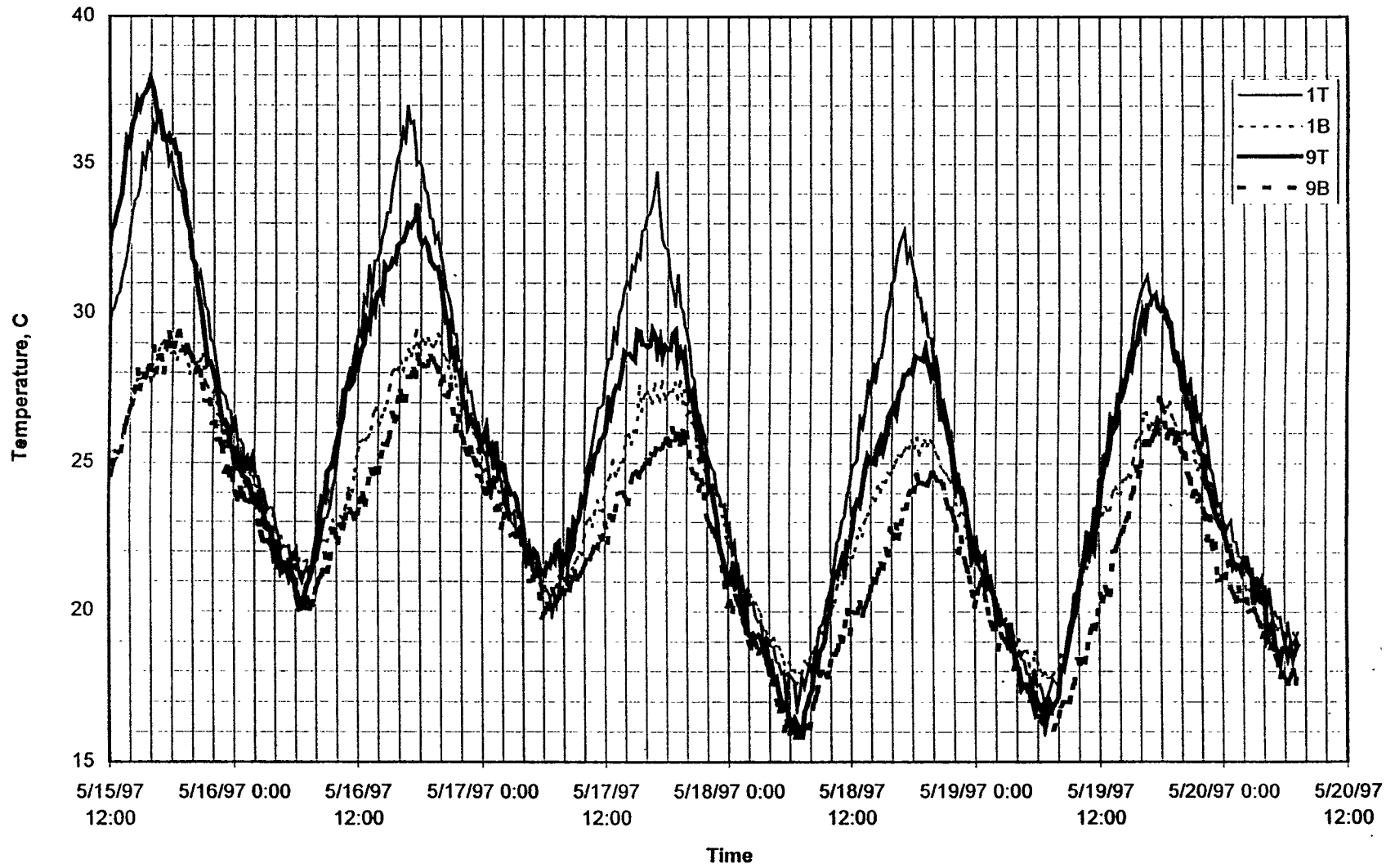

Tube Temperature, HAX2 Open Ports

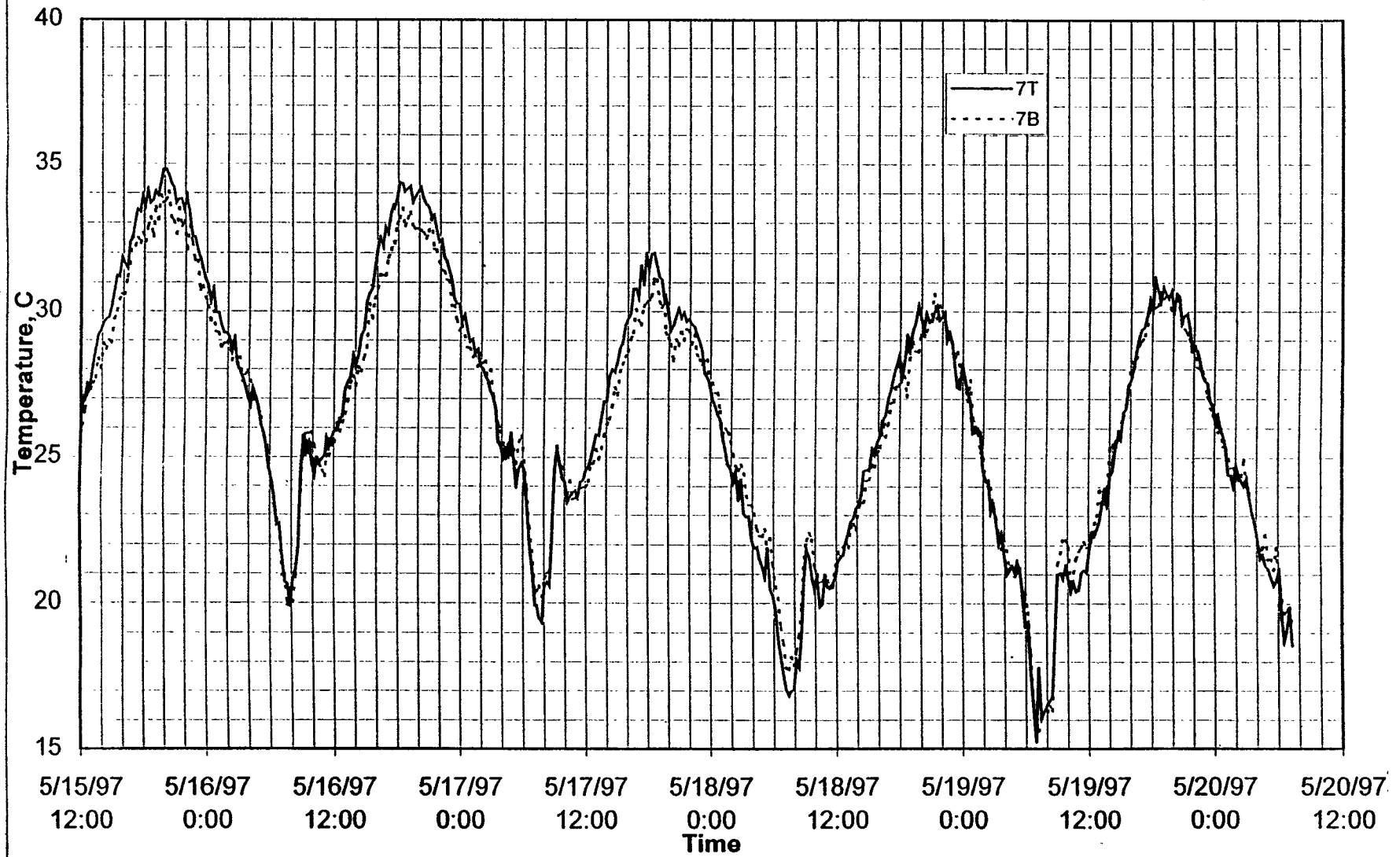

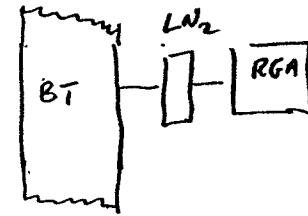
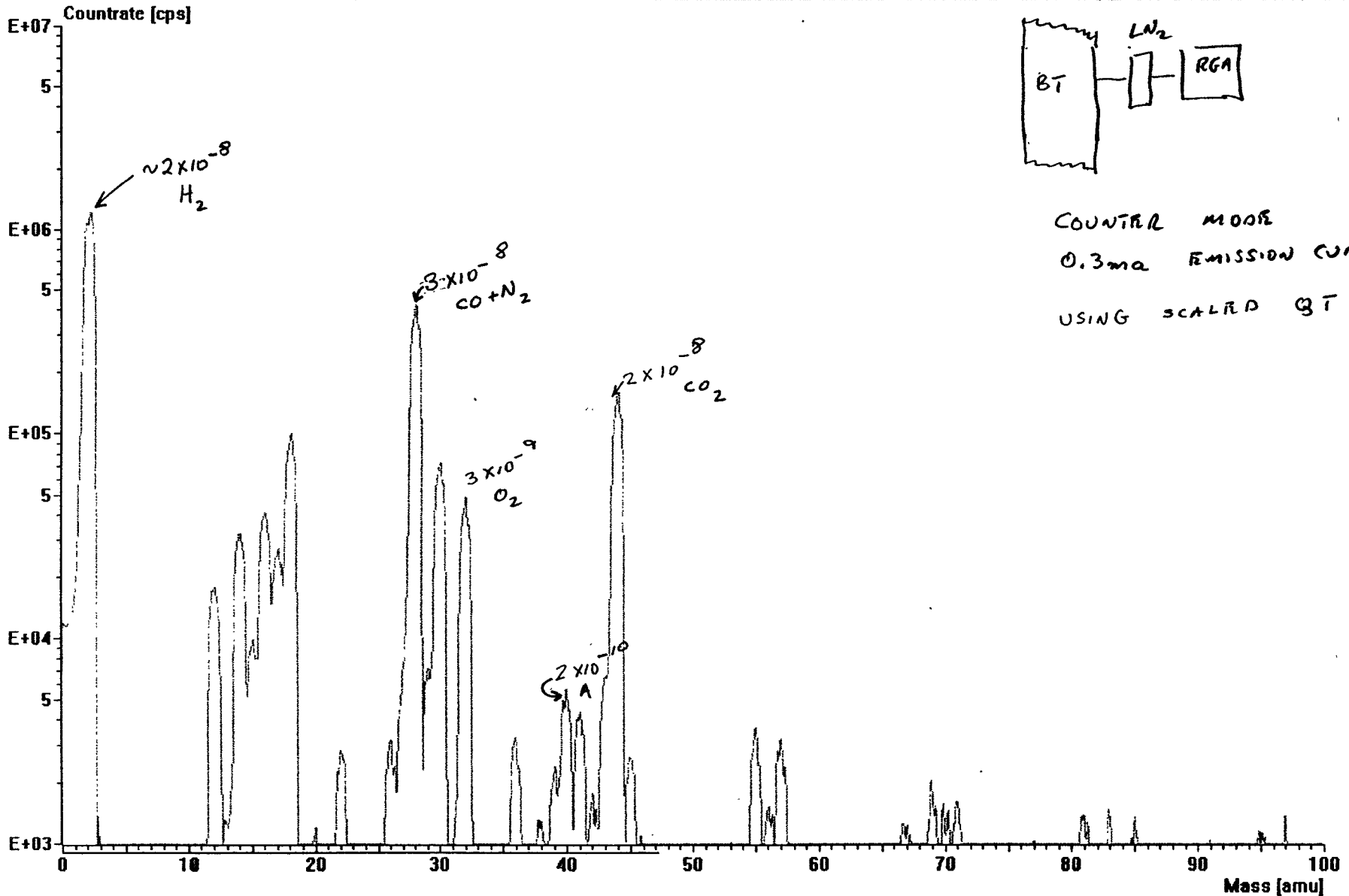

COUNTER MODE
0.3ma EMISSION CURRENT
USING SCALED BT CAL

AMU SPECTRUM BT + RGA VOLUME

5/21/97

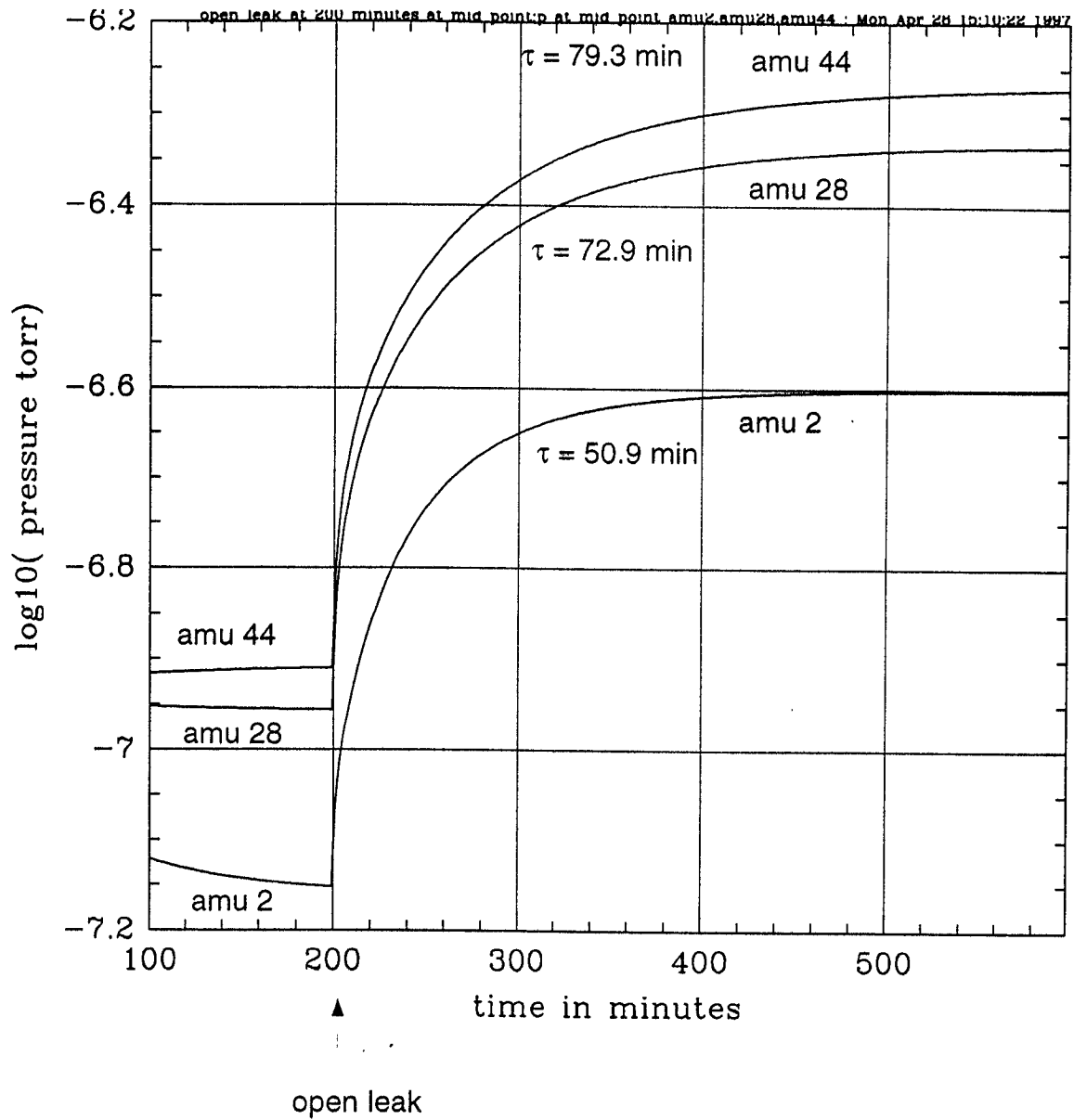

end pump 580 liters/sec
 leak at mid point 1×10^{-4} torr liters/sec all gases
 pressure measured at mid point

Figure 6 Diffusion transient in the beam tube. A leak with amu 2, 28 and 44 is opened at the mid point of the beam tube module at time 200 minutes. The pressure as a function of time measured at the midpoint is shown. The leak is 1×10^{-4} torr liters/sec for all the gases and the pumping

speed at the ends is held at 580 liters/sec. The formal lumped parameter time constant of the system, $\tau = \frac{V}{F}$, is 35 minutes.

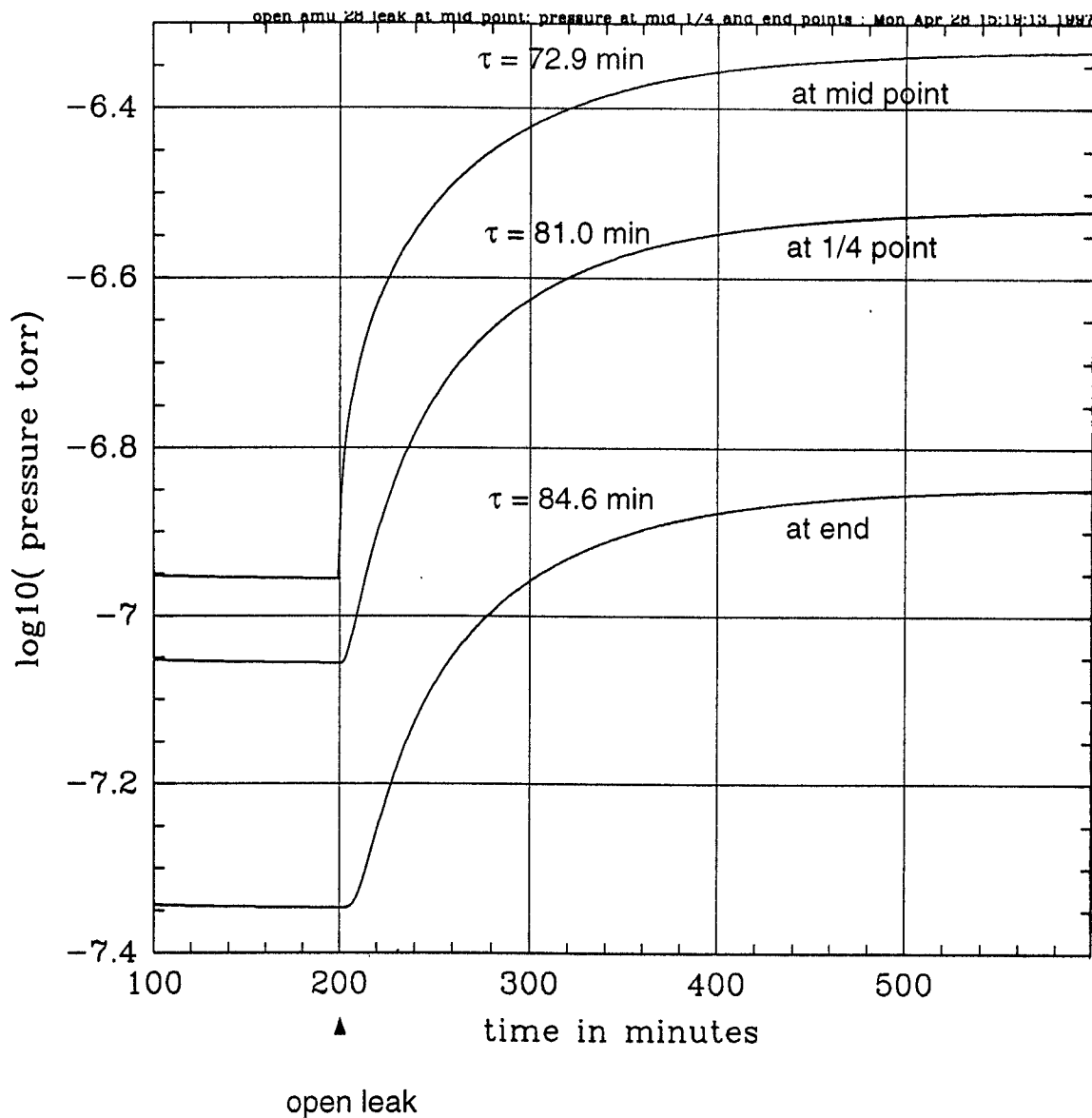

End pump 580 liters/sec
 Leak at mid point of tube 1.0×10^{-4} torr liters/sec
 amu = 28

Figure 7 Diffusion transient in the beam tube. A 1×10^{-4} torr leak of amu 28 gas is opened at the mid point at 200 minutes. The pumping speed at the ends is 580 liters/sec. The figure shows the pressure as a function time at the mid, 1/4 and end point of the tube.

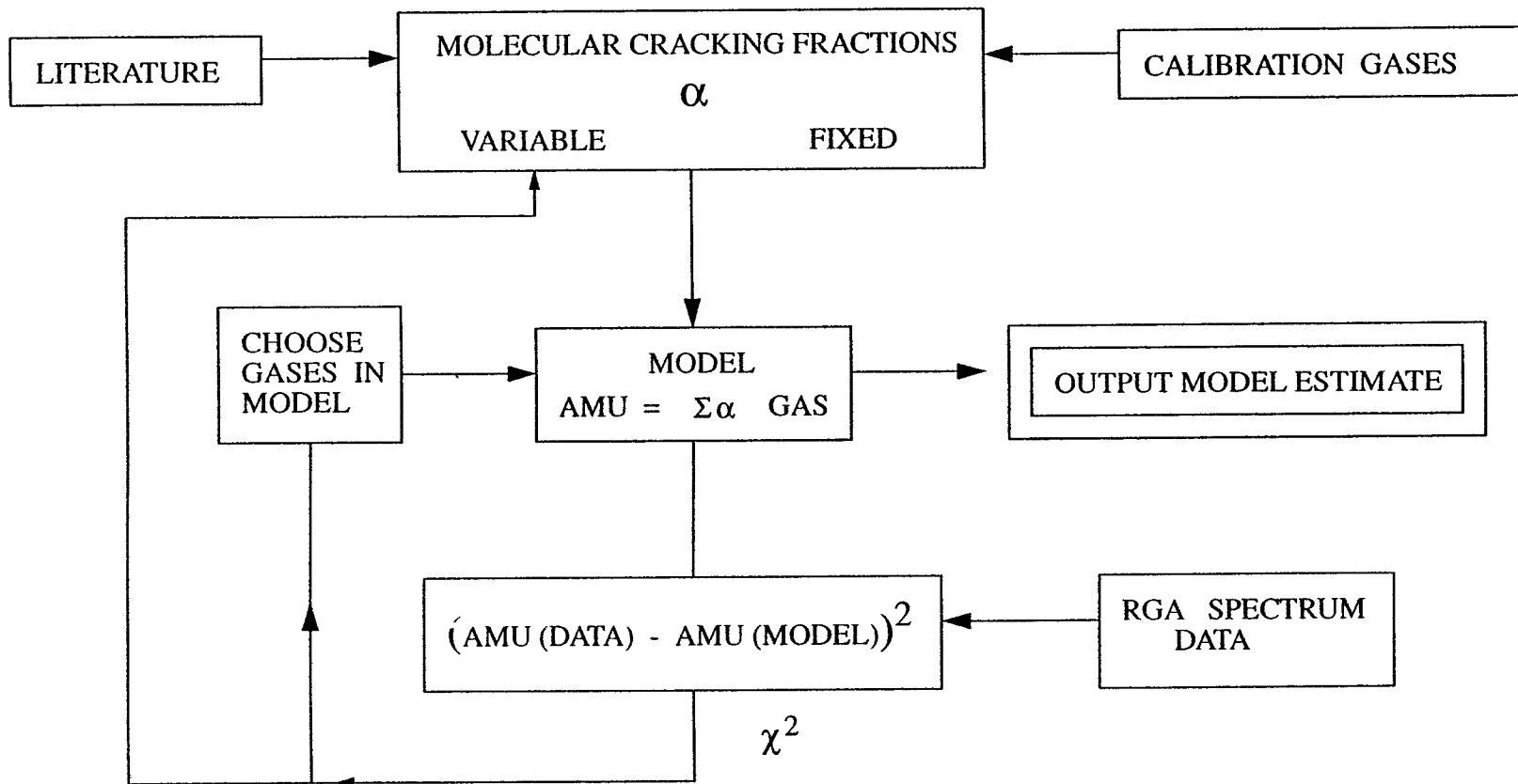

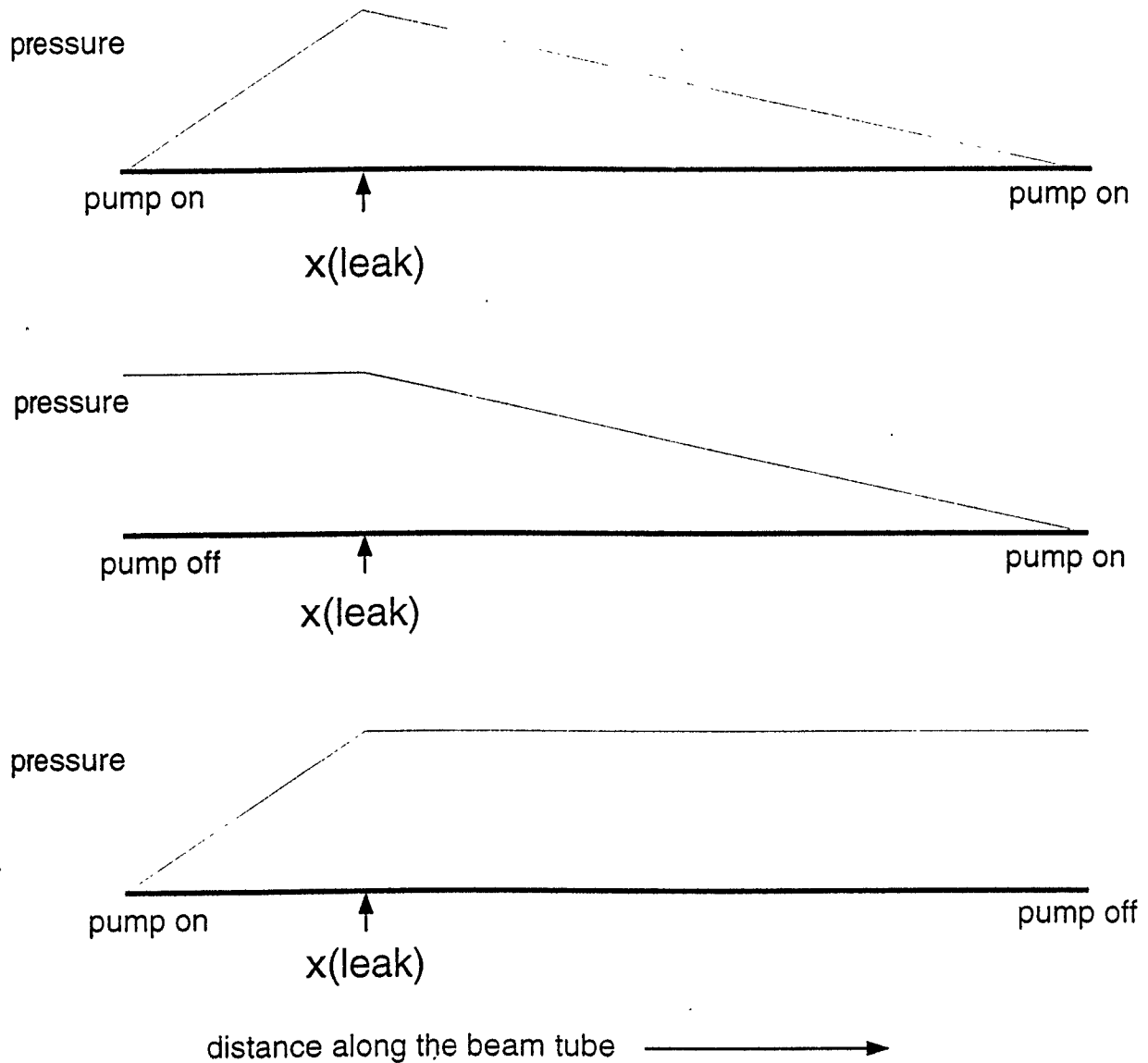

Figure 1 The pressure distribution in the beam tube for a leak at position $x(\text{leak})$. The top figure is the pressure distribution when both ends of the beam tube are pumped. The middle and the bottom are the cases when the valves are closed at one end or the other. The pattern of a second leak would be the same except that the amplitude and leak location would be different. The leak finding software is currently configured to use the pressure at the ends and at 7 locations along the beam tube. The program will try to find the best solution for the location and amplitude of 1,2,3 ..N leaks by calculating the superposed pressure distribution for the leaks and comparing it with the actual pressure data. Once one chooses the number of leaks in the model, the software tries to establish the best values of the position and amplitude of the leaks.

Automatic System Identification

D. Coyne



System Identification & Adaptive Control for LIGO Interferometers

- Motivation
- System Identification (SID)
 - ›› Model Parameter Determination
 - ›› Model Independent SID
- Adaptive Control
 - ›› Model Reference Systems
 - ›› Parameter Adaptation schemes
 - ›› Model Independent schemes

*“Far better an approximate answer to the right question, which is often vague,
than an exact answer to the wrong question, which can always be made precise.” J. Tukey, 1962*

Motivation

- Lab Experience indicates that the Interferometer “drifts”, i.e. the “plant” is nonstationary
 - ›› Periods for continuous locking are relatively short (~ minutes to hours)
 - ›› Gain and alignment settings require adjustment to new settings to hold lock
 - ›› Adjustment to date requires experienced personnel
 - ›› Murphy decrees that the same will be true (to an extent) for the “engineered” LIGO system
- LIGO Requires a Robust Fringe Locked Control (Length & Alignment) for maximum instrument availability
 - ›› Requires closed loop SID (nonlinear system -- $system_{OL} \neq system_{CL}$)
 - ›› Recursive (on-line, adaptive) SID is desirable

Motivation (Continued)

- Robustness is the property of a control system to maintain adequate performance (RP) and stability (RS) in the presence of uncertainties (input, output, and plant parameters)
 - ›› MIMO systems can display a sensitivity to uncertainty not found in SISO systems
- Potential Imperfections/Model Errors, unknowns or parameters subject to drift which could effect Control System Robustness:
 - ›› BS reflectivity \neq 50%
 - ›› Mixer Phase Error
 - ›› Deviations from resonance
 - ›› Visibility variation
 - ›› ITM/ETM absorption (radius of curvature)
 - ›› Sensor & Actuator cross-talk (optical, mechanical & electrical)
 - ›› Alignment/Length Coupling
 - ›› Modulation depth & phase variation
 - ›› etc.

IFO Control Topology

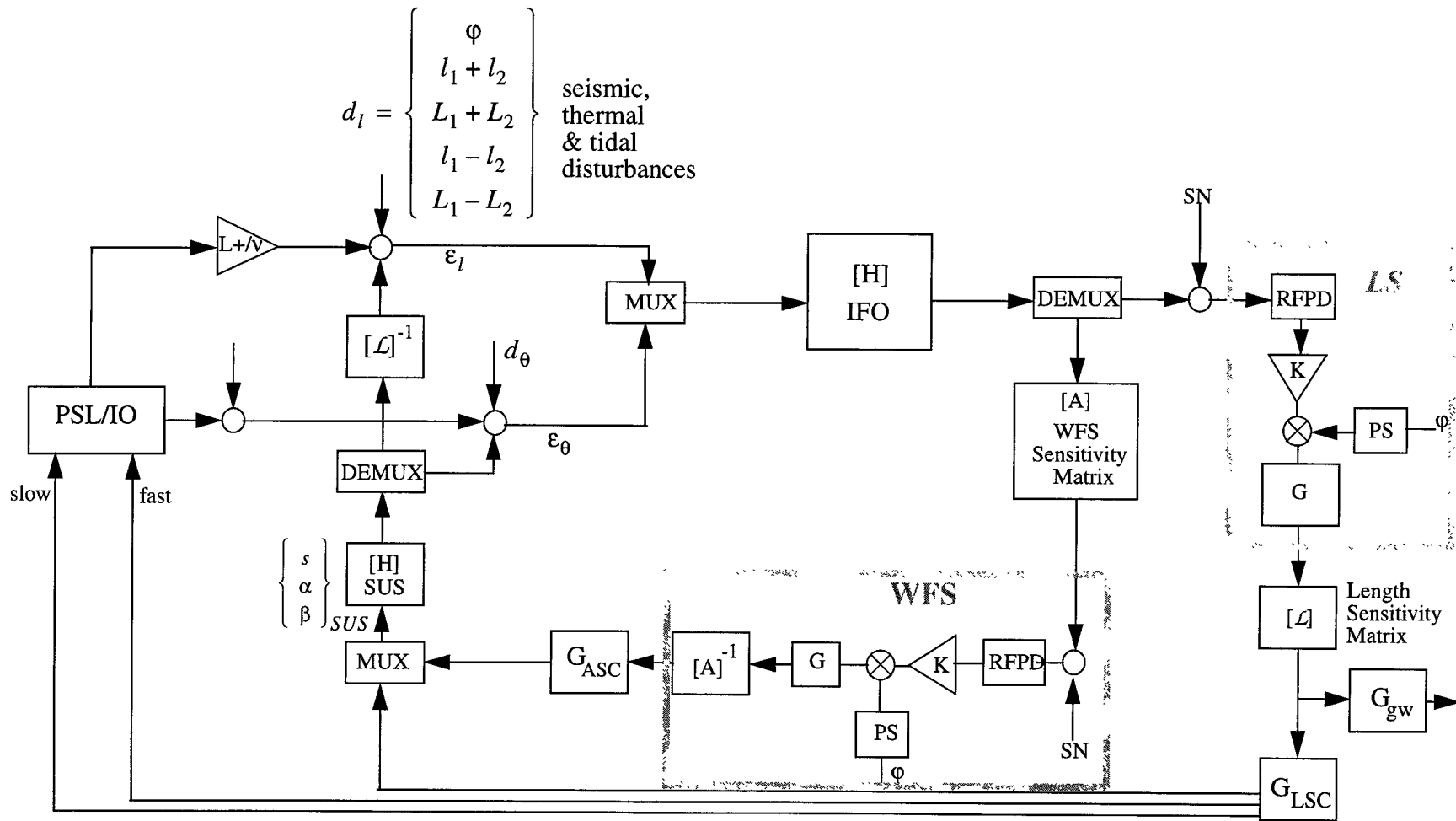

System Identification is related to IFO Diagnostics

›› System Identification is the experimental approach to dynamic process modeling

›› Conventional Approach (“remote diagnostics”) is an analysis of the results of experiments designed to characterize the elements of the system (plant, sensors, actuators, disturbance processes, etc.)

›› Ideally the SID is a multivariate, recursive (on-line, adaptive) identification of the closed loop system

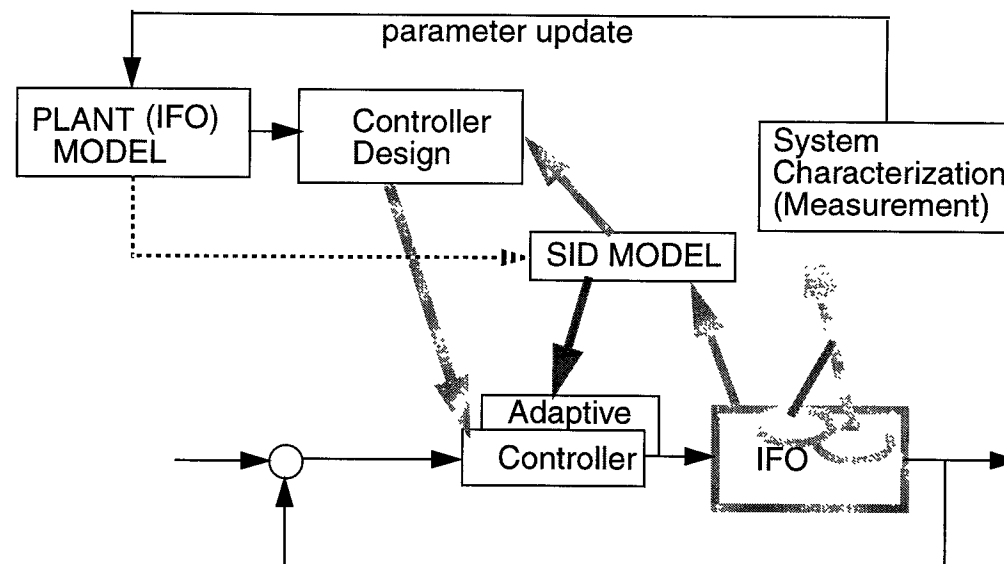

System Identification (continued)

- Multivariate methods

- ›› principal components, factor analysis, cluster analysis

- ›› Least Squares (LS), Best Linear Unbiased Estimators (BLUE), Maximum Likelihood Estimators (MLE)

- ›› SVD of “measurement matrix” for psuedo-inverse of overconstrained systems, e.g an overdetermined WFS Sensitivity matrix, $A^\dagger = (A^T A)^{-1} A$

- Characterization of dynamical systems

- ›› correlation analysis, spectral analysis (nonparameteric estimation)

- ›› LS and MLE techniques have been extended to dynamic model identification (e.g. State Space Form)

- ›› If the noise in a dynamic system is correlated, then a least squares estimator of the system parameters will not be “consistent”

- ›› SID techniques such as “generalized least squares” overcome this inconsistency problem

State Space SysID

- Stochastic State Space description:

$$\dot{x} = Ax + Bu + w$$

$$y = Cx + Du + e$$

or

$$y = Gu + He$$

where

$$G = C(qI - A)^{-1}B + D$$

$$H = C(qI - A)^{-1}K + I$$

K = steady state Kalman gain matrix

e = white noise

- Prediction Error from Input/Output Observations:

$$\varepsilon = H^{-1}[y - Gu]$$

- Prediction Error Method (= MLE for Gaussian disturbances)

$$[\hat{G}, \hat{H}] = \min \left(\int_{t_1}^{t_2} \varepsilon^2 dt \right)$$

Recursive SysID

- A Recursive ID Algorithm:

$$\hat{G}(t) = \hat{G}(t-1) + \kappa(t)[y(t) - \hat{y}(t)]$$

- Propagator:

$$\kappa(t) = Q(t)\Psi(t)$$

where

$$\Psi(t) = \frac{\partial \hat{y}(t|\hat{G})}{\partial \hat{G}}$$

$Q(t)$ = adaptation gain matrix; If the (presumed) underlying description of the observations is a linear regression, then $Q(t)$ is computed from the Kalman filter.

Adaptive Control

- Ideally design a controller which is robust enough to accommodate all parameter variations (generally a performance trade-off)
- If required performance and plant variations require adaptation:
 - ›› First use operational mode dependent control, and/or gain scheduling
 - ›› If this is inadequate, then adaptive control may be necessary (adds complexity)
- Some fundamental types of adaptive control
 - ›› Model Reference Systems
 - ›› Parameter Adaptation Scheme
 - ›› “Model Independent” Schemes

Model Reference System

- Specified dynamic response of the closed loop system is characterized by a reference model driven by the same input
- Parameters of the control system (considered to be most useful to control) are adjusted to minimize the integral of the error squared

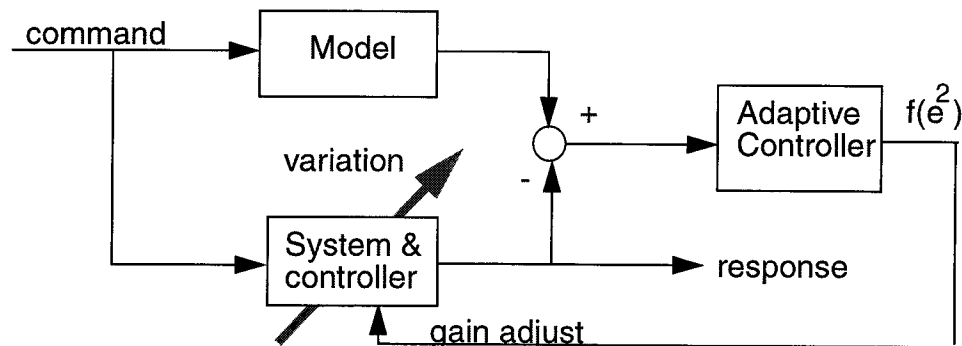

Parameter Adaptation Scheme Example

- Robustness

- ›› Linear Quadratic Regulator (LQR) is unstable if the mass of the secondary deviates +0.05% or -4% the system

- ›› Could improve robustness by e.g. SysID, or H_∞ design, μ -synthesis controller, or Gain “Tuning”

- ›› Example: Fuzzy Logic MIMO Gain Tuning

An Example Structure for Controls-Structure Interaction (CSI):
The Draper ACOSS-4 Tetrahedral Truss

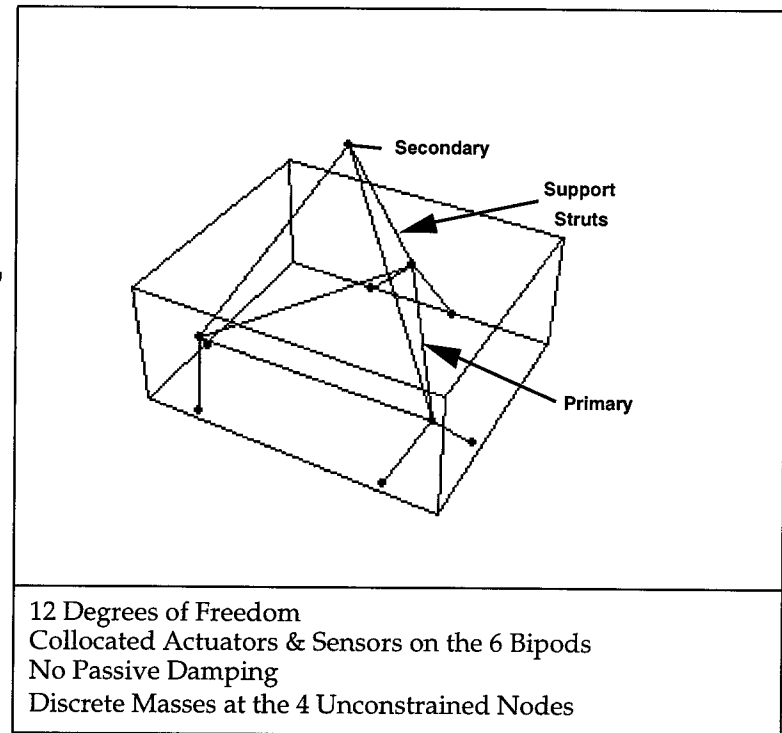

Adaptive Control: Fuzzy Logic MIMO Tuning (continued)

- Supervisory Control

- ›› One possibility is a fuzzy logic system, for adaptive tuning of a conventional MIMO controller

- ›› More direct (and hence faster) than any approach employing system identification as a first step

- ›› can maintain stability and reasonable performance, i.e. "good enough" but not "optimal"

- ›› $[K]_{24 \times 6}$ -- can't reasonably expect an operator to tune it up

Example Fuzzy Logic Controller Block Diagram for Adaptive Tuning of a Conventional MIMO Controller

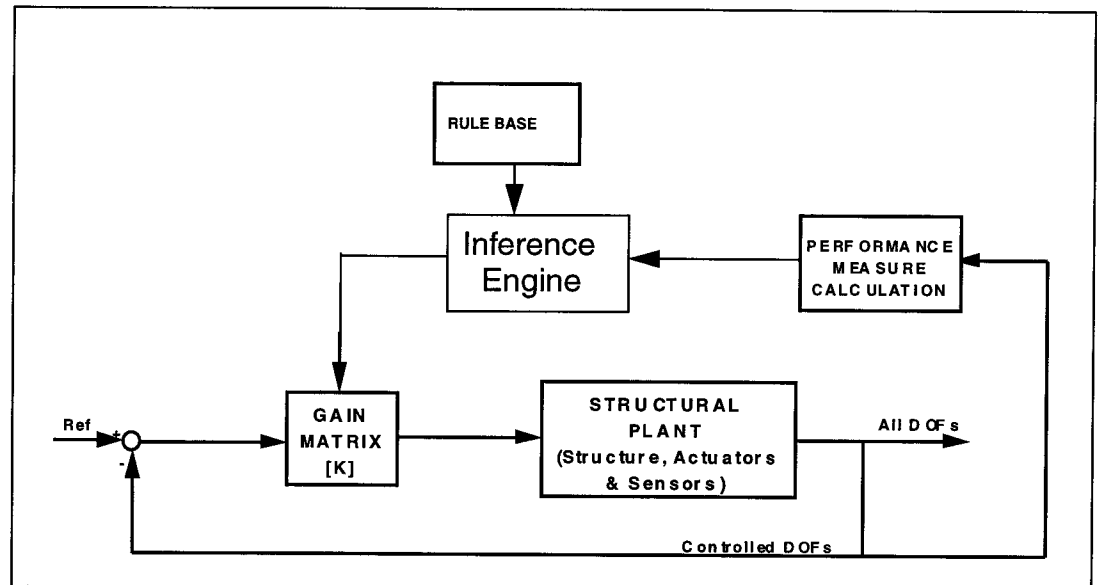

Adaptive Control: Fuzzy Logic MIMO Tuning (continued)

• Performance Measures & Fuzzy Sets

›› "box car" variances of the modal participation factors, x , and the variances of modal contributions to LOS jitter

›› The stability of control for each mode i was established by observing the time change in the variance of the modal participation, x_i

		Required Damping $\sigma^2_{LOS_i}$			
		Large	Medium	Small	Zero
Stability $t(\sigma_{x_i}^2)$	Clearly Unstable	Negative Big (NB)	Negative Medium (NM)	Negative Small (NS)	Negative Small (NS)
	Marginally Unstable	Negative Medium (NM)	Negative Small (NS)	Negative Small (NS)	-
	Marginally Stable	Positive Medium (PM)	Positive Small (PS)	Positive Small (PS)	-
	Clearly Stable	Positive Big (PB)	Positive Medium (PM)	Positive Small (PS)	-

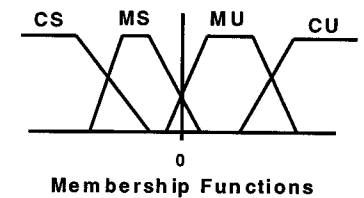
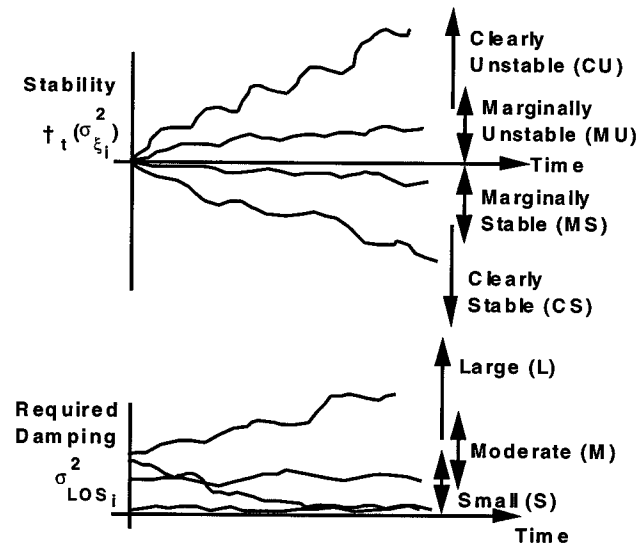

Adaptive Control: Fuzzy Logic MIMO Tuning (continued)

- Nominal LQR and Fuzzy Logic Based LQR Tuning Response to a Destabilizing Change in the ACOSS-4 Structure (+4% Mass added to the “secondary”)

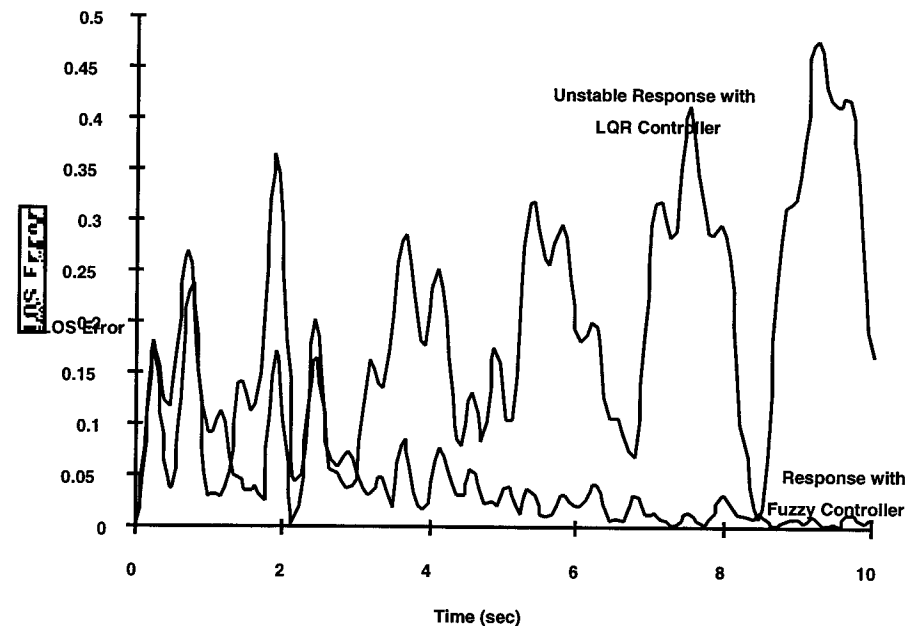

SID

Model Independent

- An Artificial Neural Network (ANN) is used to identify the system (SID) based upon an error signal and learning algorithm

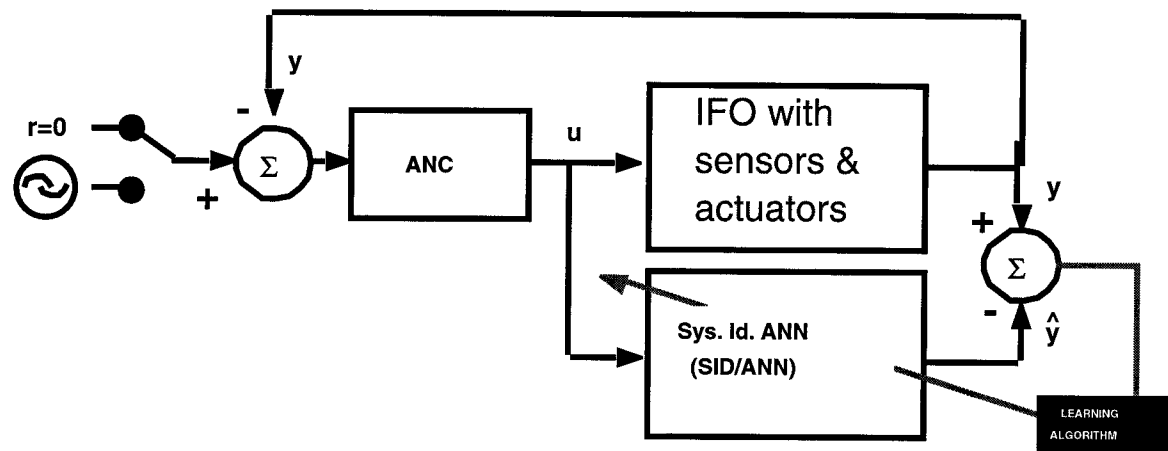

Adaptive Control: Model Independent

- An Artificial Neural Controller (ANC) is connected either to the Plant for control or to the SID/ANN for training and updating

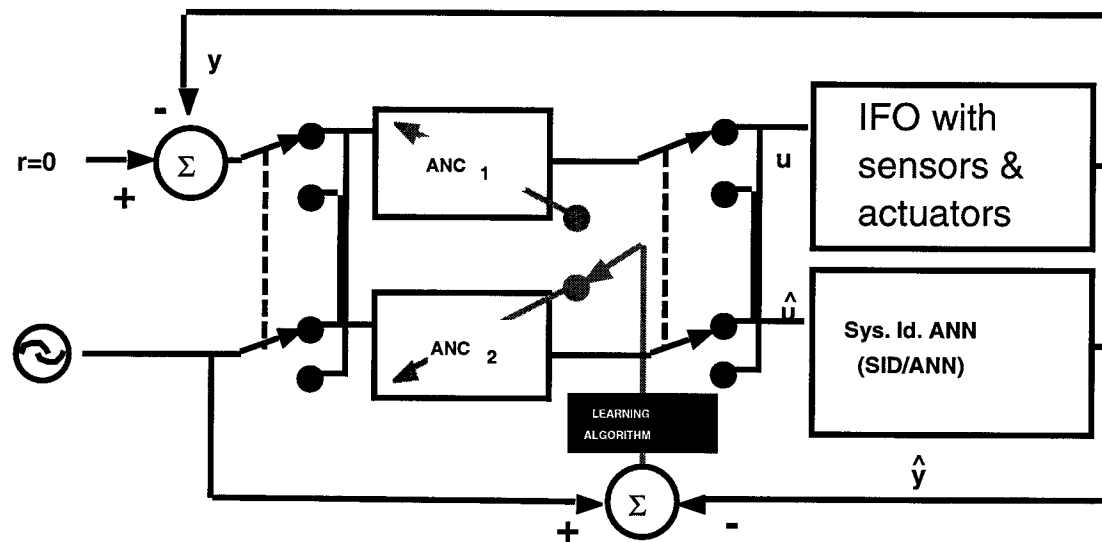

SID & Adaptive Control for LIGO

- The LIGO system is complex and nonstationary (if lab experience is indicative of the operational system)
- An (semi)automated means for SID is essential
- In addition Adaptive Control might be required (added complexity to be compared to potential benefits)
- Closely associated with the IFO Diagnostics effort and similar to the Advanced/Operational R&D Topic proposed by R. Spero & J. Camp
- Proposal:
 - ›› Trial investigation with 40m data by team of interested sci/eng
 - ›› When successful, consider PostDoc hire & implications for LIGO

Integrated Detector Diagnostics

R. Weiss



INTEGRATED APPROACH TO

DETECTOR DIAGNOSTICS

MULTIVARIATE ANALYSIS

REFERENCES

MULTIVARIATE STATISTICAL METHODS
D. MORRISON

MULTIVARIATE DATA ANALYSIS
F. MURTAGH + A. HECK

3/

HOPEO FOR RESULTS

- * COMPACT DETECTOR CHARACTERIZATION
REDUCED DATA SETS

- * TECHNIQUE TO SEARCH FOR
 - Δ UNMODELLED NOISE SOURCES
 - Δ UNMODELLED GW SOURCES

- * ORGANIZE COMPARISON OF NOISE THEORY
WITH INSTRUMENT PERFORMANCE

- * FUN TO DO

3)

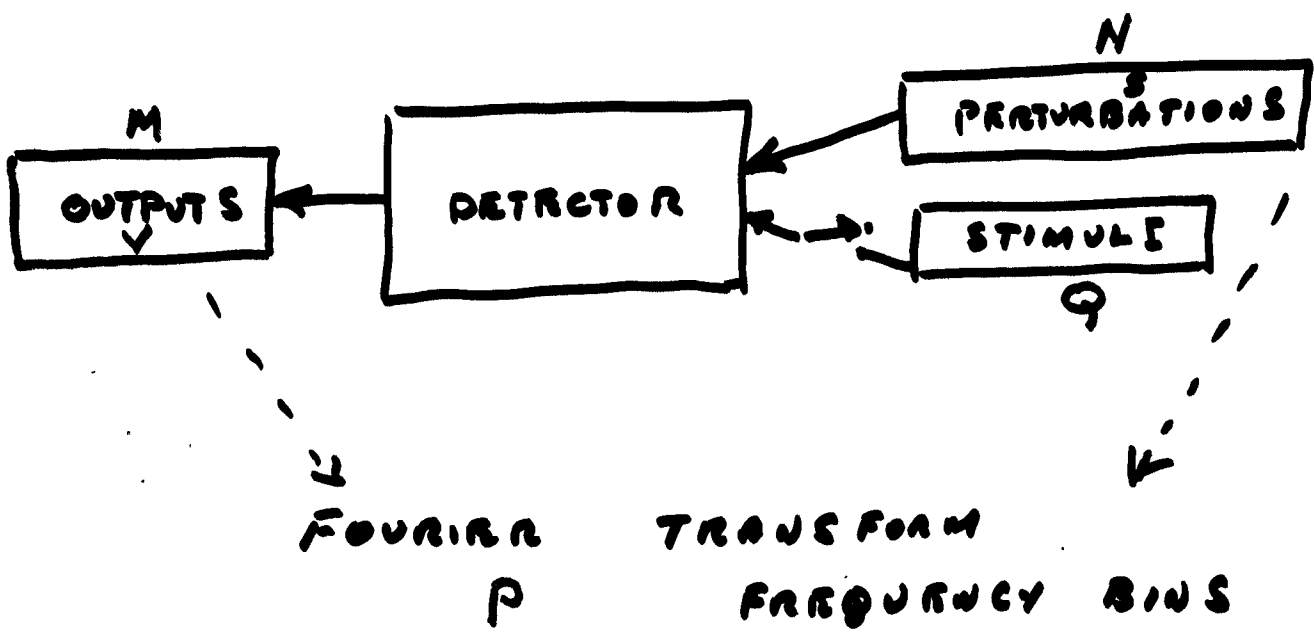

FOR ALL P COMPONENTS

1) COVARIANCE ANALYSIS
DUMB BUT MODEL INDEPENDENT

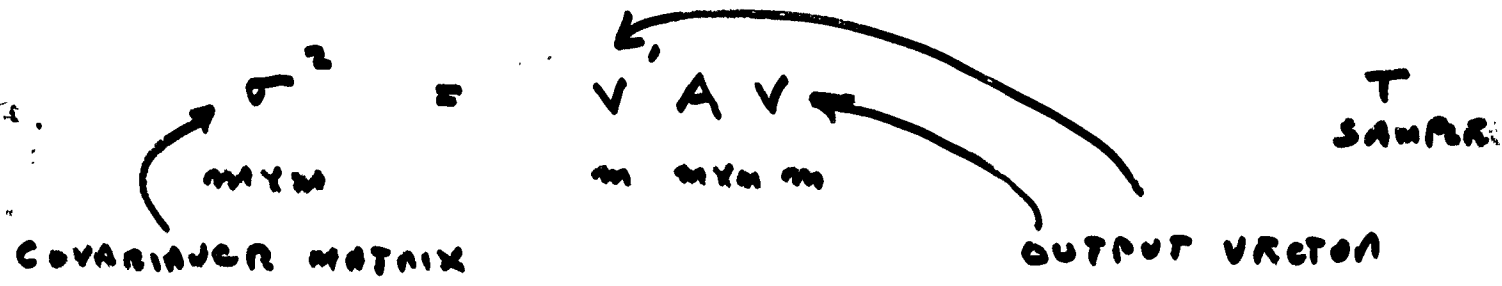

2) PRINCIPAL VALUE DECOMPOSITION

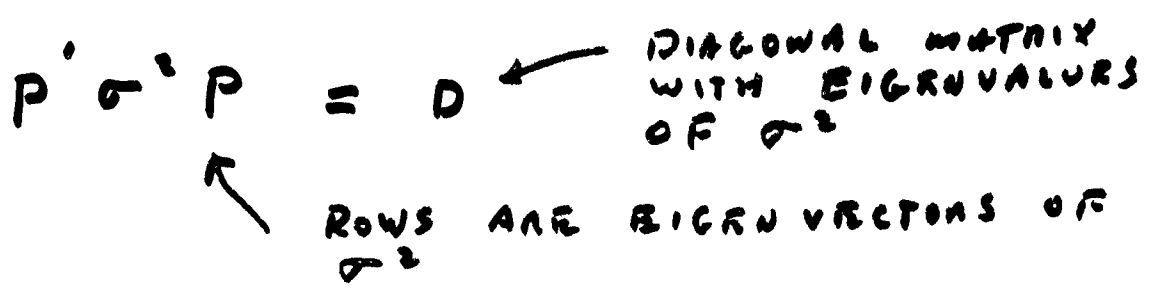

4)

EIGENVECTOR

$$y = P'v$$

THE VARIANCE

$$\text{VAR} = \lambda_1 y_1^2 + \lambda_2 y_2^2 + \dots + \lambda_n y_n^2$$

MAKE THE SPECTRUM ASSOCIATED WITH EACH EIGENVALUE AND VECTOR

EXPECT

PROGRESSIVELY SMALLER λ $1 \rightarrow n$
PROGRESSIVELY WHITER SPECTRA $1 \rightarrow n$

FIT TO THEORETICAL NOISE MODELS

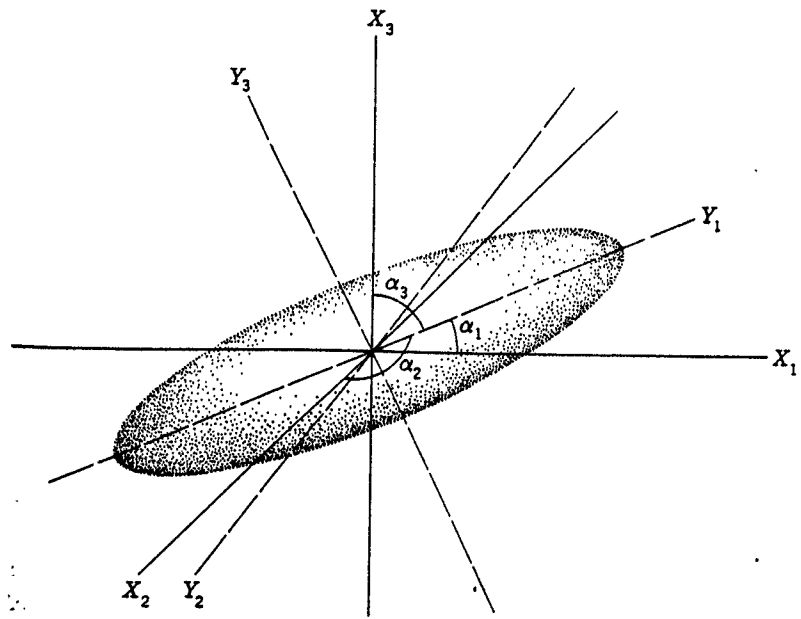

Principal axes of trivariate observations.

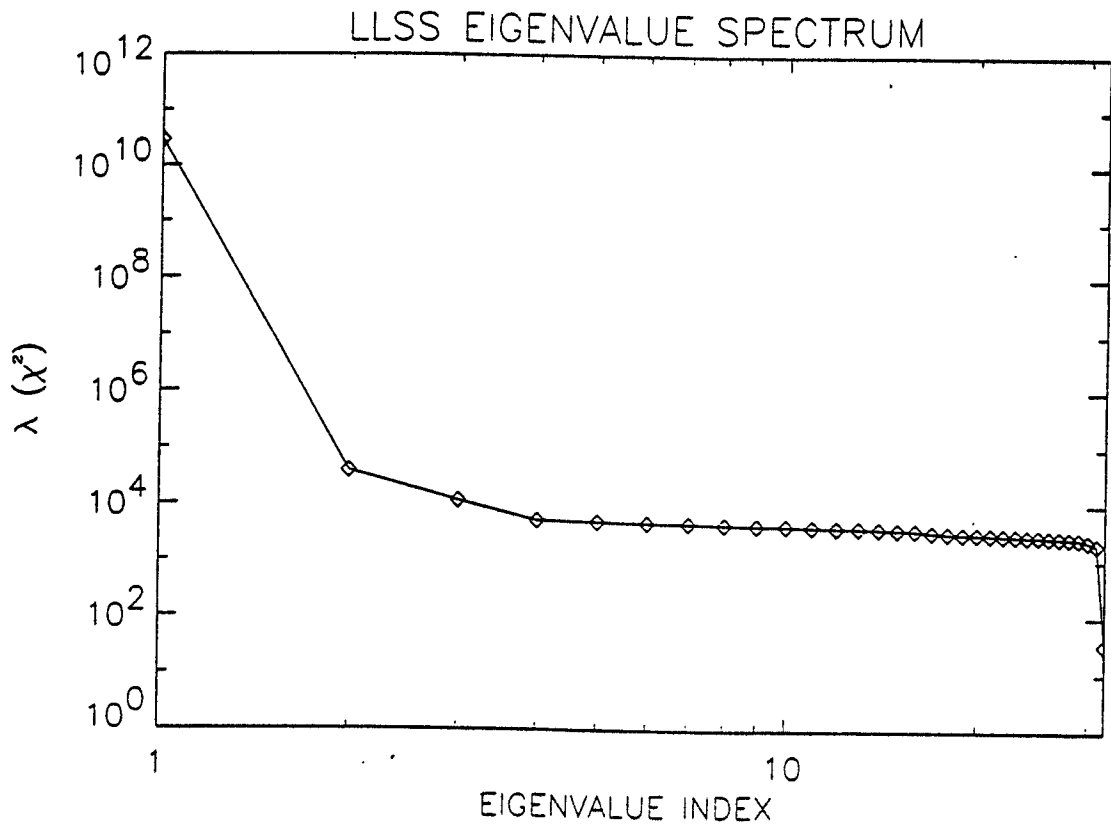

Figure 7-1: Eigenvalue spectrum for LLSS

From

A MODEL OF GALACTIC DUST AND GAS FROM FIRAS
WILLIAM BARNES MIT PHYSICS PHD 1994

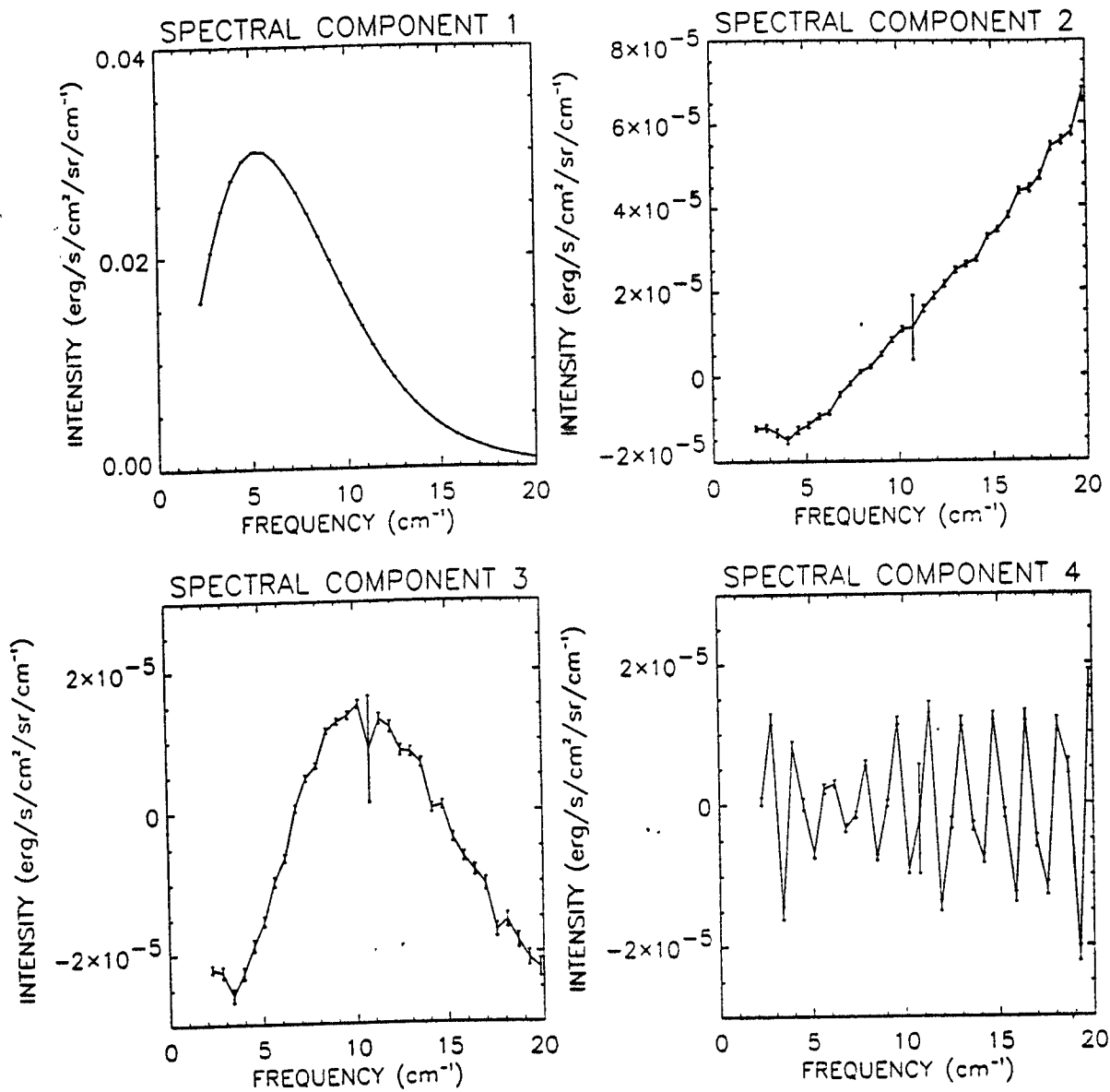

Figure 7-3: First 4 spectral components for LLSS

From

A MODEL OF GALACTIC DUST AND GAS FROM FIRAS
 WILLIAM BARNES MIT PHYSICS PHD 1994

7)

FACTOR ANALYSIS → COVARIANCE ANALYSIS
SMARTER APPROACH

MODEL OUTPUTS FROM PERTURBATIONS

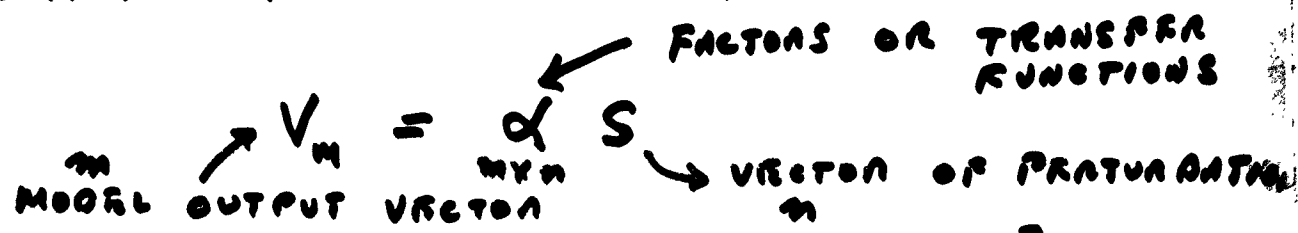

WHERE α CHOSEN TO MINIMIZE χ^2

$$\chi^2 = \sum_m (V - V_m)^2$$

$$\text{OR } \sum_m |V - V_m|$$

COVARIANCE ANALYSIS WITH RANDOM VECTORS

$$\sigma^2 = (V' - V_m') A (V - V_m)$$



SAME AS BEFORE

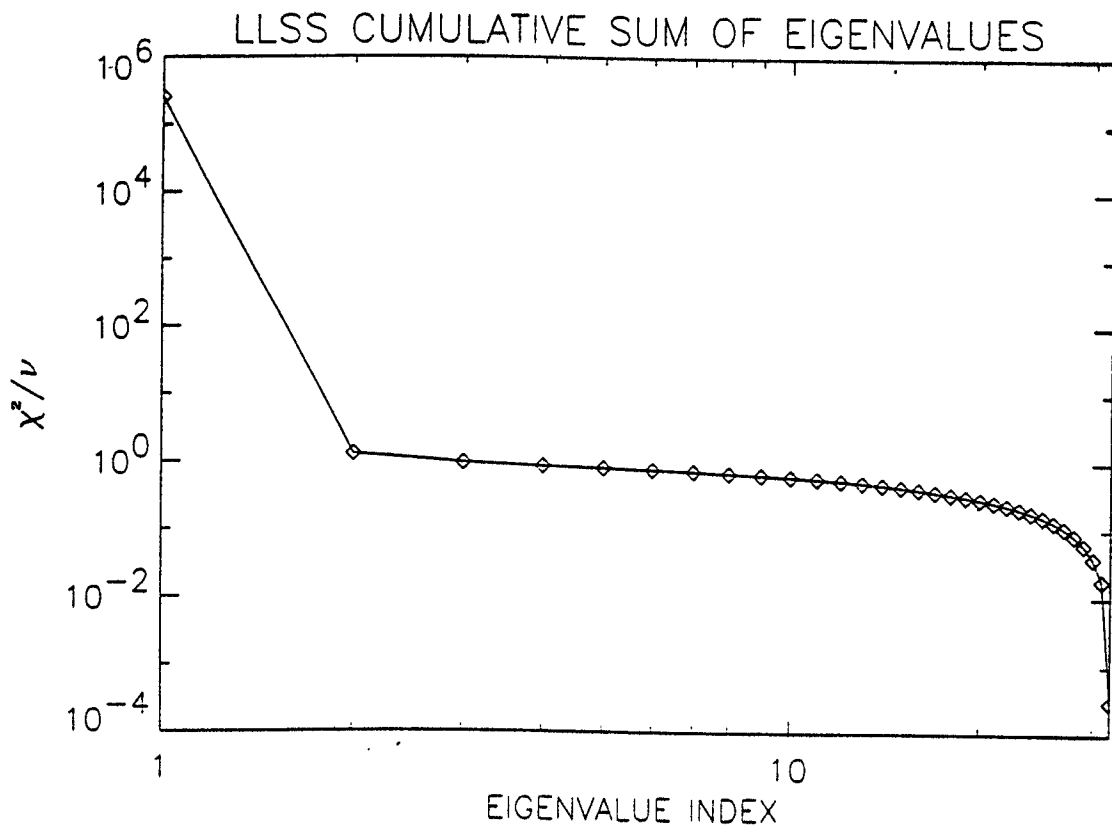

Figure 7-2: Plot of $\sum_{i=r}^N \lambda_i / \text{DOF}$ vs. eigenvalue index r for LLSS

From

A MODEL OF GALACTIC DUST AND GAS FROM FIRAS
 WILLIAM BARNES MIT PHYSICS PHD 1994

40m End-to-End Model

M. Evans and M. Rahman



ADLIB and the End-to-End Simulation

Matt Evans

- **Cohorts**
 - ›› Hiro Yamamoto
 - ›› Malik Rahman
- **Goals**
 - ›› Answer Design Questions for Initial and Advanced LIGO
 - ›› General Diagnostic Tool
 - ›› Aid in Understanding Noise Sources
 - ›› Pseudo Data Source (Data Analysis Aid)
- **Today's Topics**
 - ›› Brief overview of ADLIB, the framework on which the End-to-End Simulation will be built
 - ›› Construction of a Simplified PSL
 - ›› Digital Filters with examples (Malik Rahman)

ADLIB Overview

Matt Evans

- **Structure**

- ›› general framework for simulating optical systems with feedback
- ›› time domain simulation
- ›› modular (object oriented)
- ›› expandable

- **A Few Basic Optical Elements**

- ›› Mirror

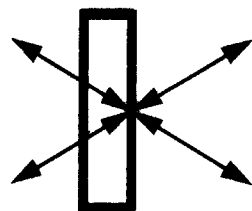

- ›› Propagator



- ›› Pockels Cell



- ›› Photodetector

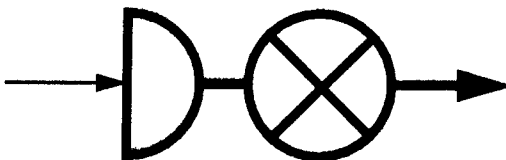

Simplified PSL

Matt Evans

- **Laser**
 - ›› frequency noise (f^{-2} power spectrum)
 - ›› no intensity noise
 - ›› flat PZT transfer function
- **Mode Cleaner**
 - ›› 1m F-P cavity
 - ›› perfect length reference (no mirror position noise)
- **Control**
 - ›› in phase demod output sent to SPZT with gain (flat transfer function)
 - ›› no common mode input
- **Note:** construction of this model required no C++ coding, just a flow chart of the 40m PSL

Simplified PSL

Matt Evans

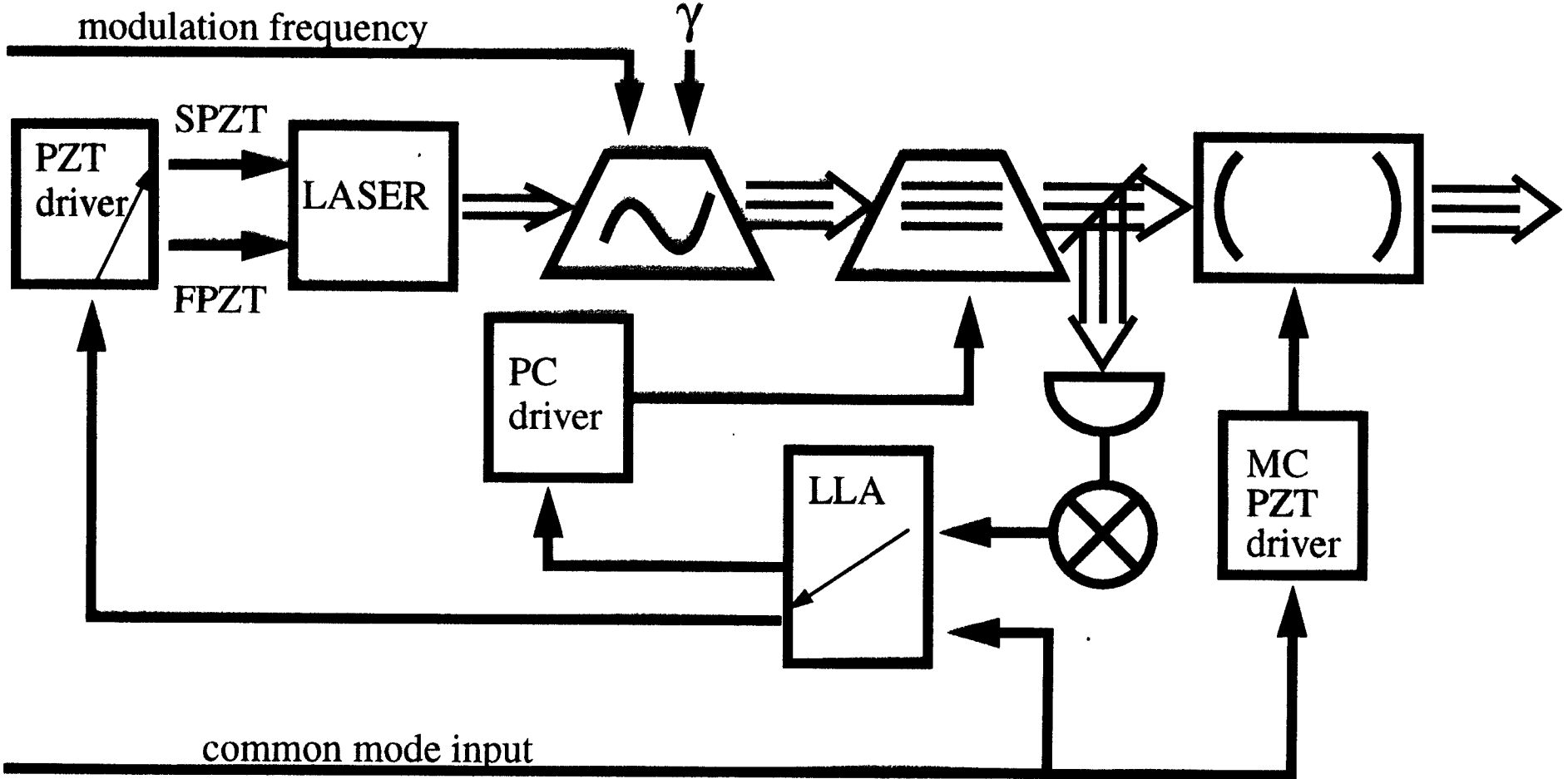

Red: Implemented Components
Blue: Components TBD

PSL Demod Output and Error Signal

Matt Evans

- Open Loop
 - ›› frequency/phase noise from Laser uncontrolled
 - ›› demod output reflects frequency variation
- Close Loop
 - ›› error signal sent to SPZT
 - ›› frequency variation attenuated

PSL Demod Output and Error Signal

Matt Evans

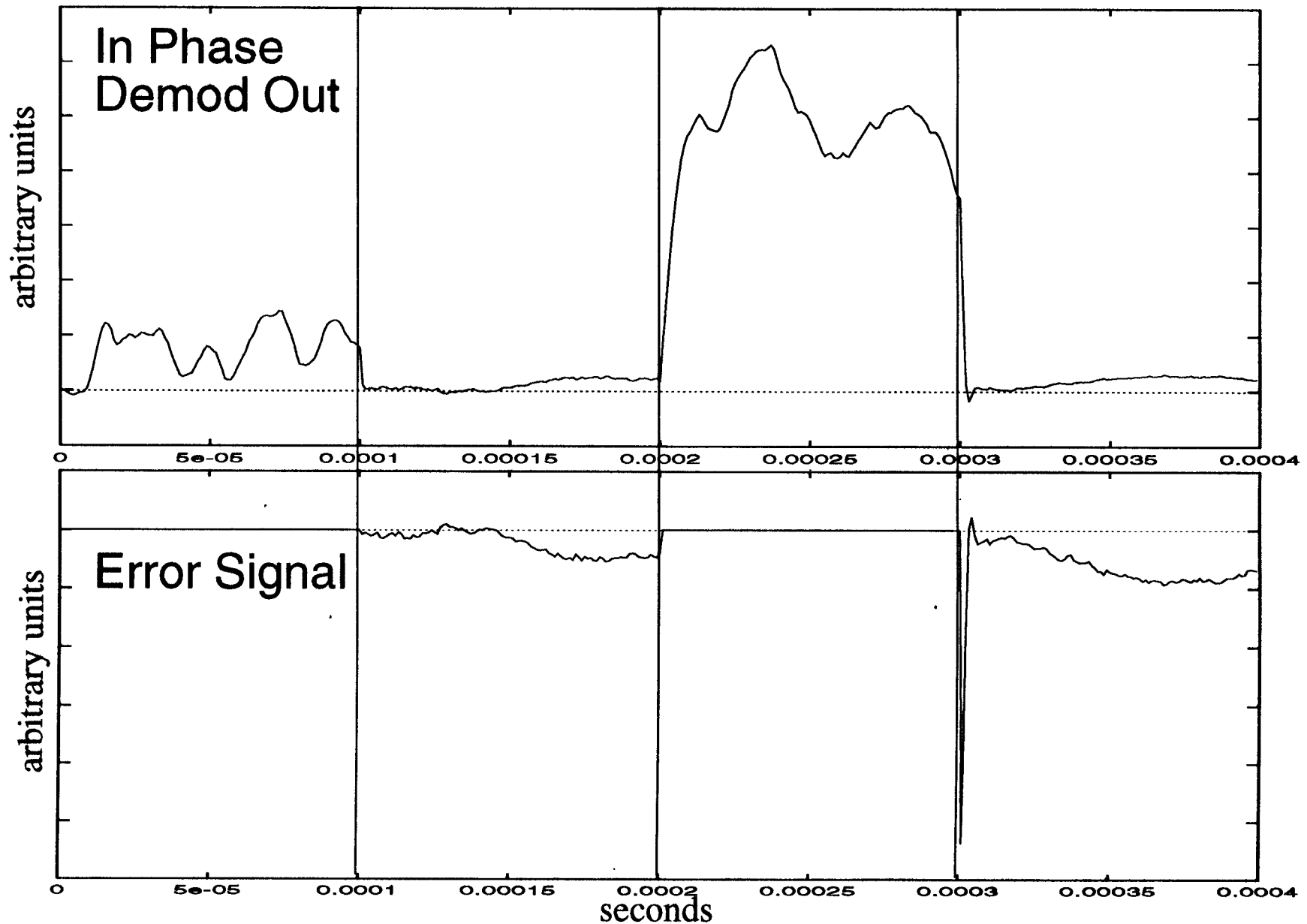

PSL Phase of MC Output Light

Matt Evans

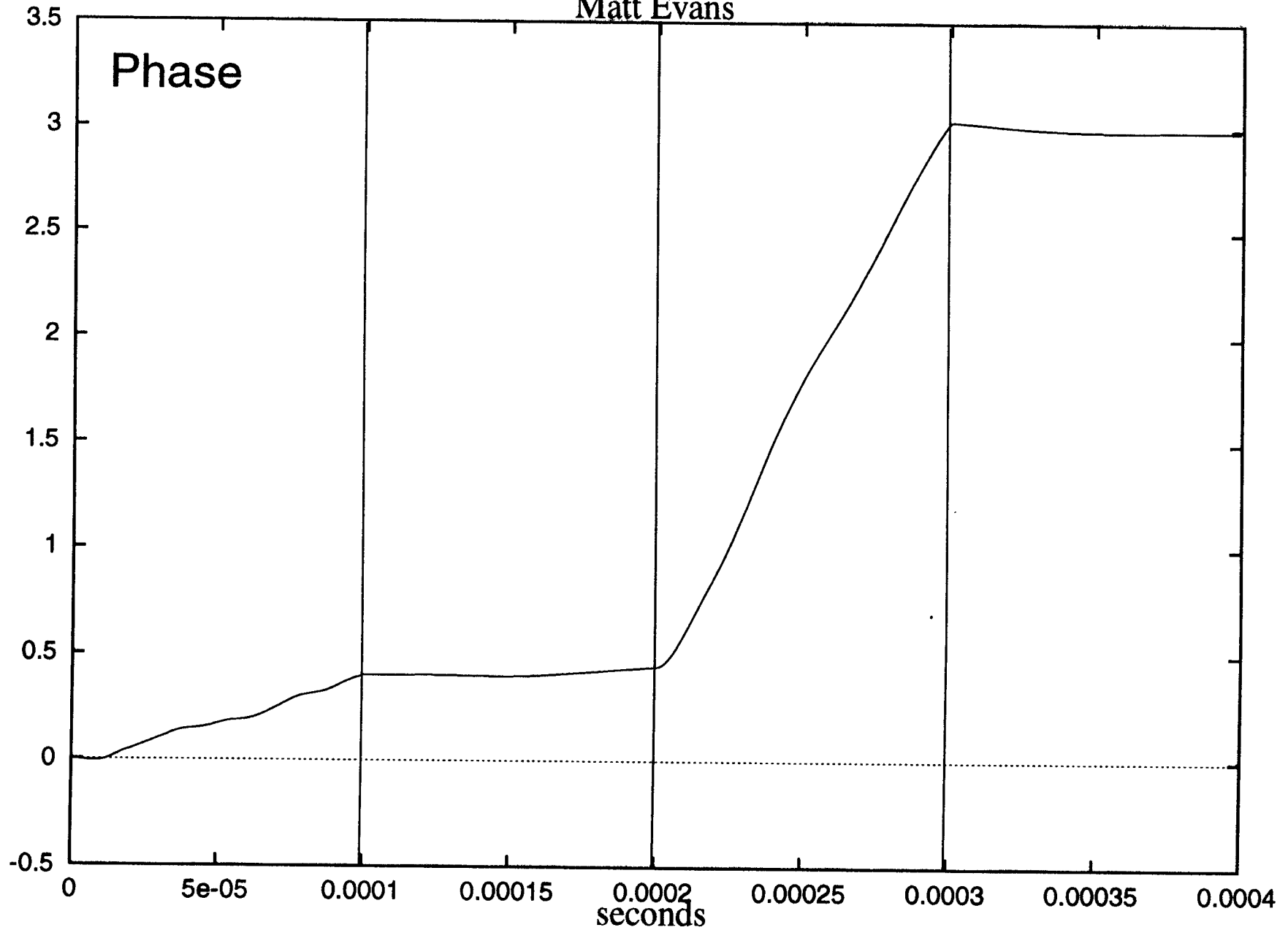

Digital Filters in the 40m End-to-End Model with Examples

Malik Rahman

- Discrete Processes
 - ›› Construction of the Digital Filters
- Examples from Suspension Subsystem
 - ›› What is modeled
 - ›› Block diagrams and connection diagram
 - ›› Digital Filters for pendulum and shark detector

Discrete Processes

›› Continuous Processes

- Current and voltage in analog electronics
- Mechanical vibrations

›› Discrete Processes

- Time domain simulation
- Discrete time: $t_n = nT$, where T - time step
- Discrete Signal: x_n
- Sampled Signal: $x_n = x(nT)$

Construction of Digital Filter

›› Digital Filter = Linear Transformation

›› Canonical Form:

$$\begin{aligned} - \quad & y_n = b_0 x_n + b_1 x_{n-1} + \dots + b_M x_{n-M} - \\ - \quad & \quad \quad - a_1 y_{n-1} - a_2 y_{n-2} - \dots - a_N y_{n-N} . \end{aligned}$$

›› The Coefficients:

$$- \quad a_k, b_k = \text{function (poles, zeros, T)}$$

Suspension Subsystem

>> What is modeled:

- Seismic motion of the suspension point = x_s
- Motion of suspension wire attached to PZT = x_w
- Motion of Test Mass = x_m

Connection Diagrams

Suspension

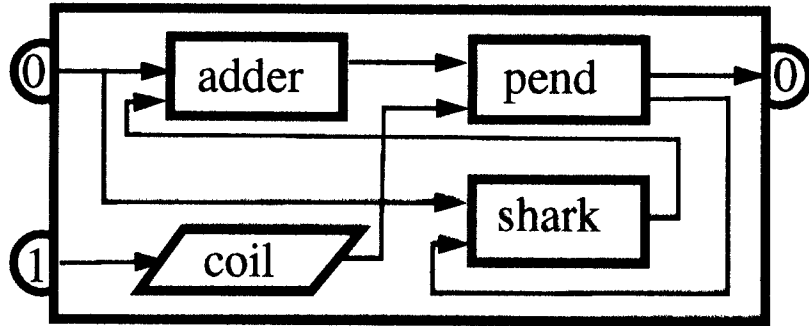

Shark

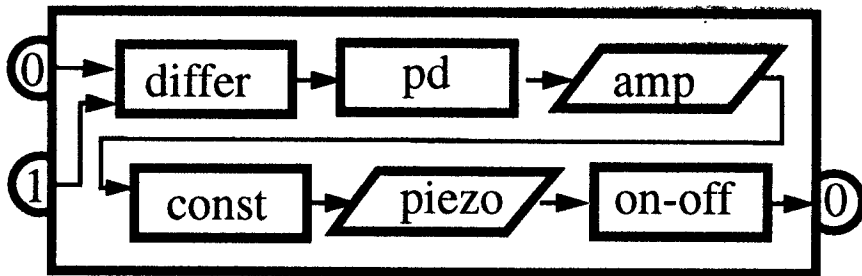

Pendulum

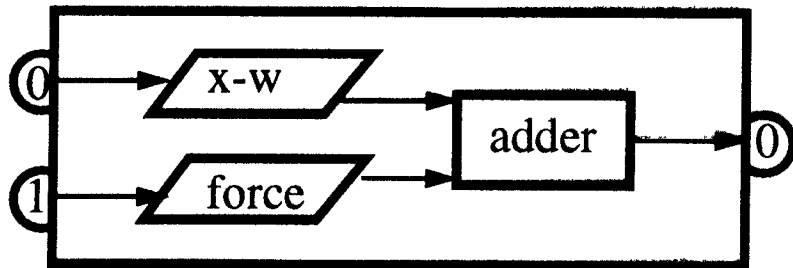

box

module

Digital Filter

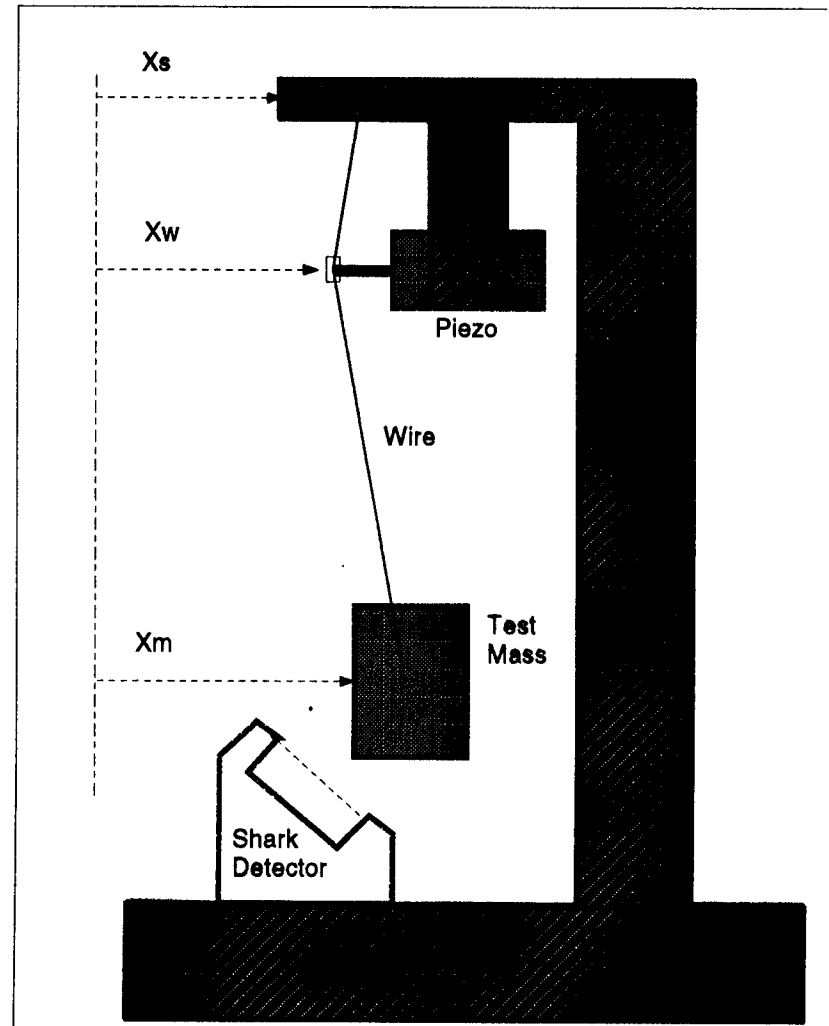

Examples of Digital Filters

›› Transfer Function of Pendulum (resonance = 1 Hz, Q ~ 1000)

- $z = -2.37e4$ rad/sec
- $p_1 = 2\pi (5.0e-2 + 1.0i)$ rad/sec
- $p_2 = 2\pi (5.0e-2 - 1.0i)$ rad/sec

›› Transfer Function of Shark Detector (from HP Spectrum Analyzer)

- $z = 0.0003$ rad/sec
- $p_1 = -1.0$ rad/sec
- $p_2 = -11.4$ rad/sec

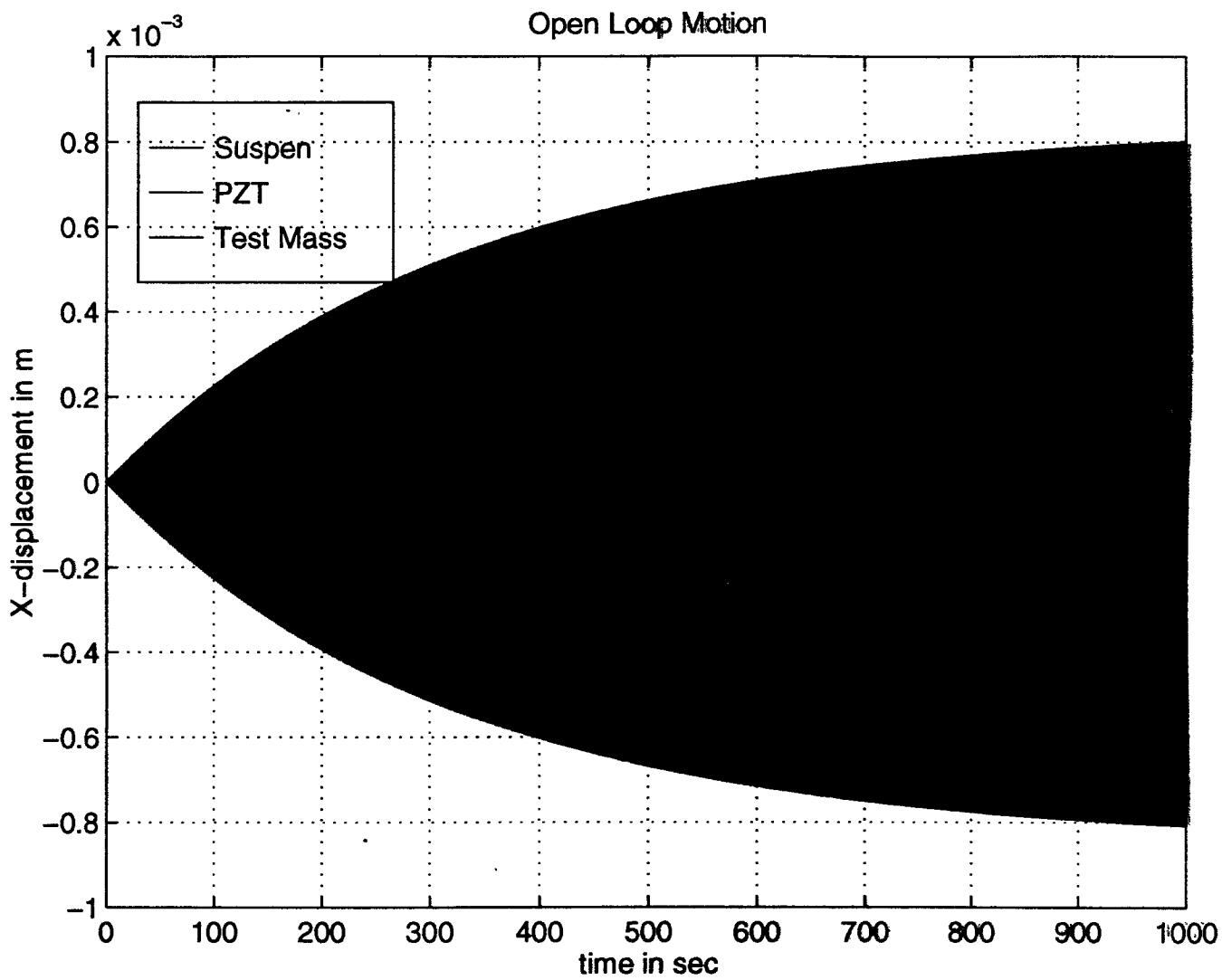

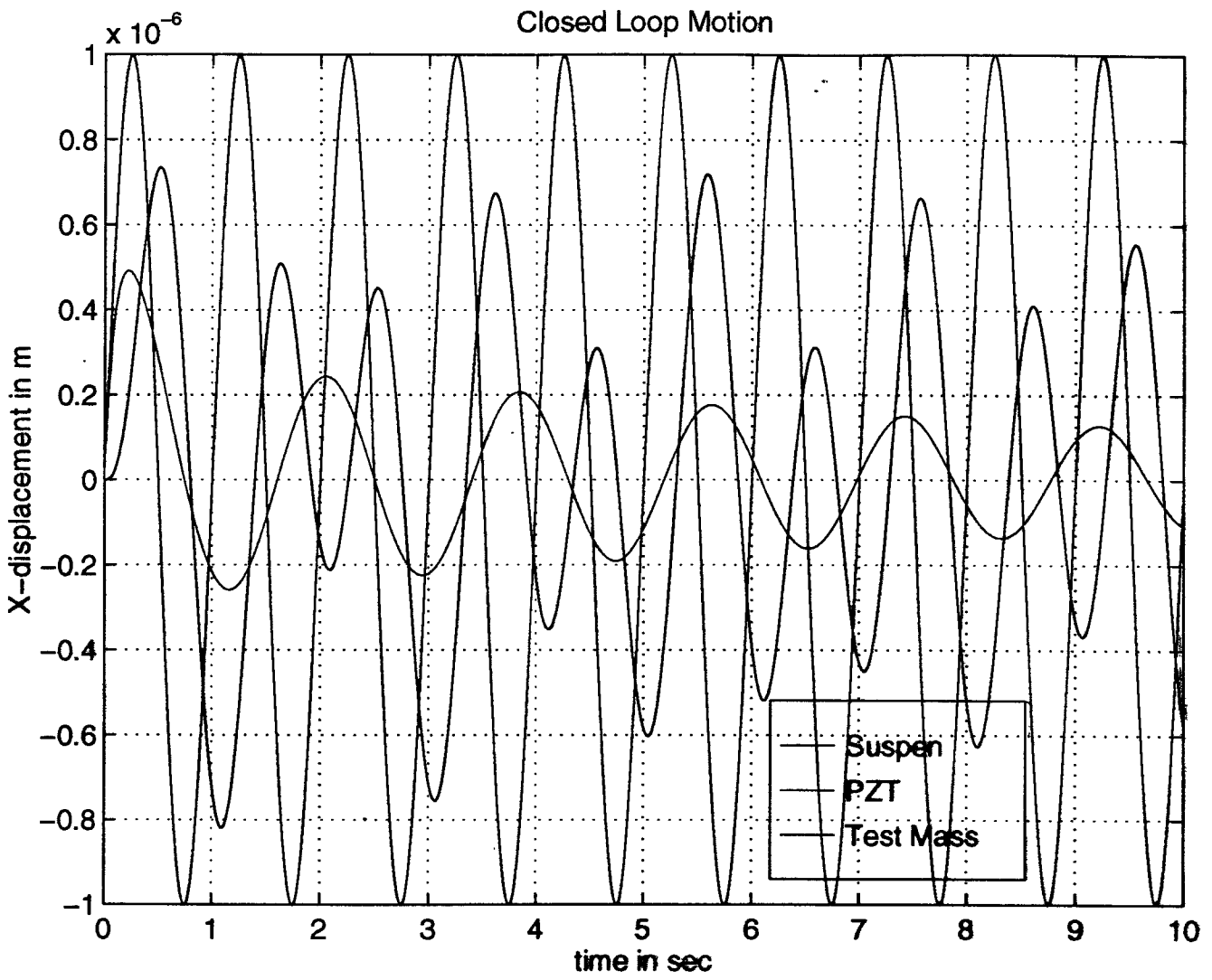

Realistic Closed Loop Motion

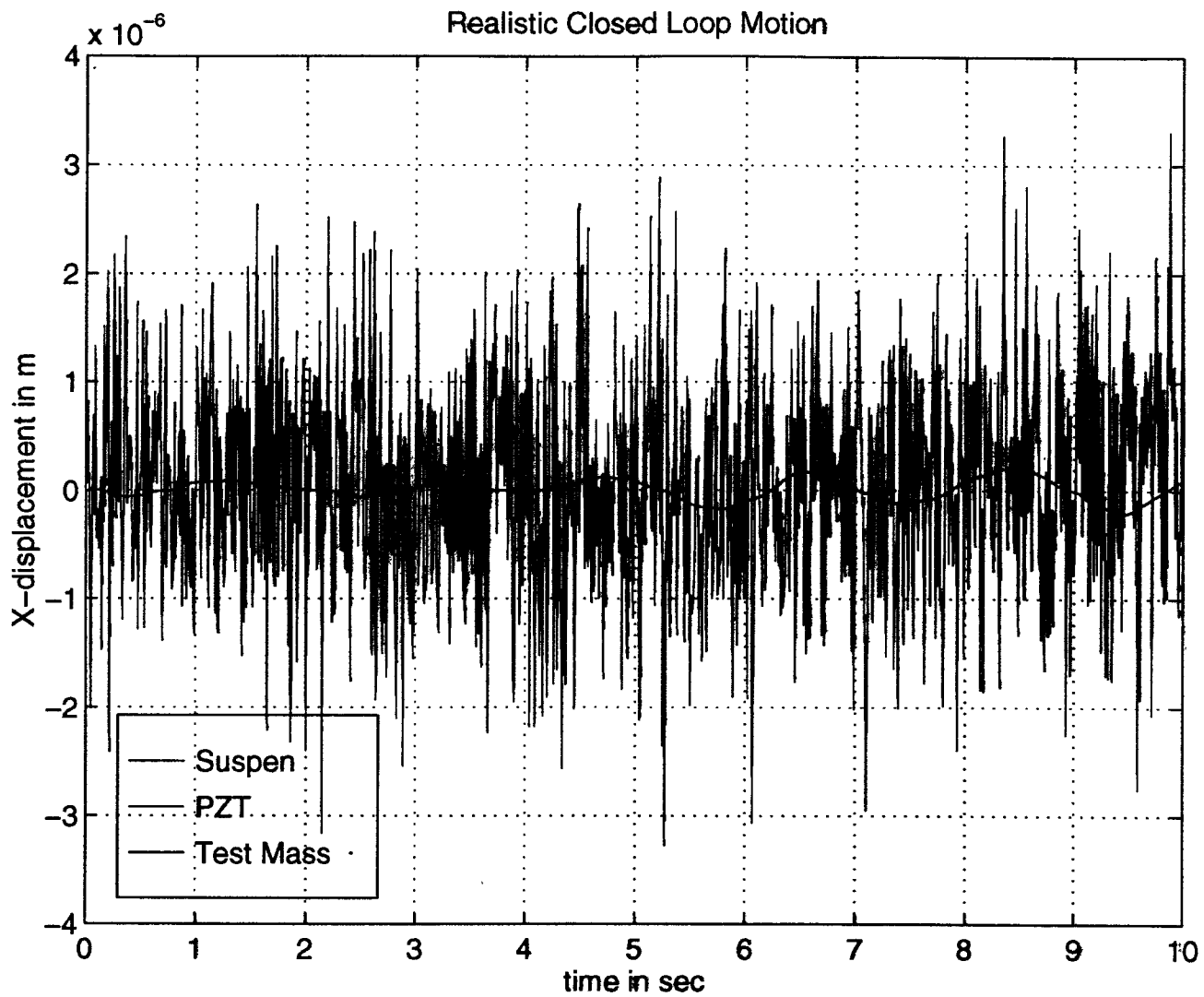

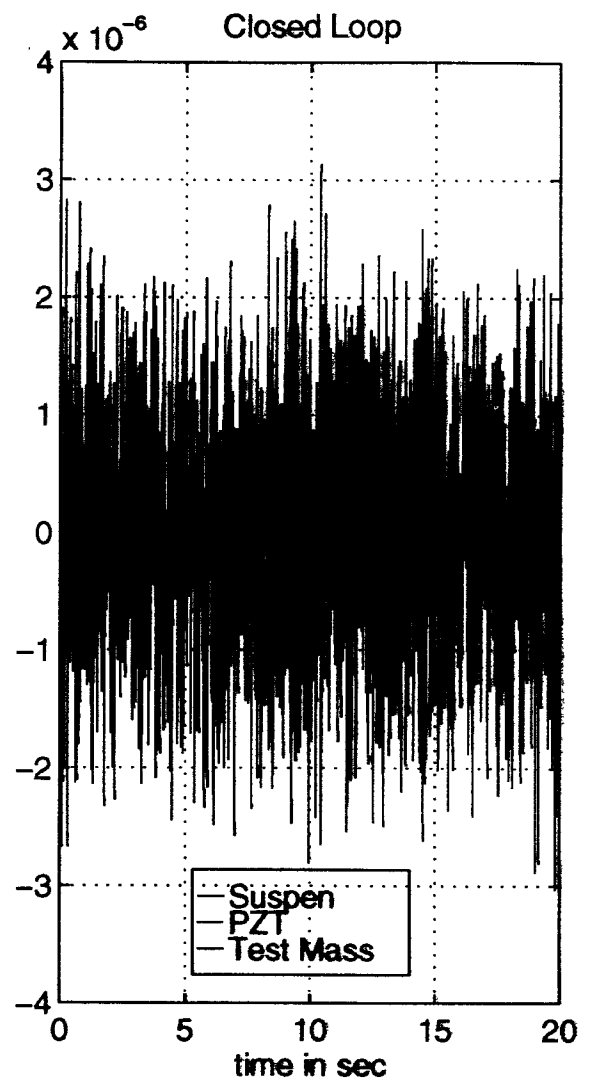
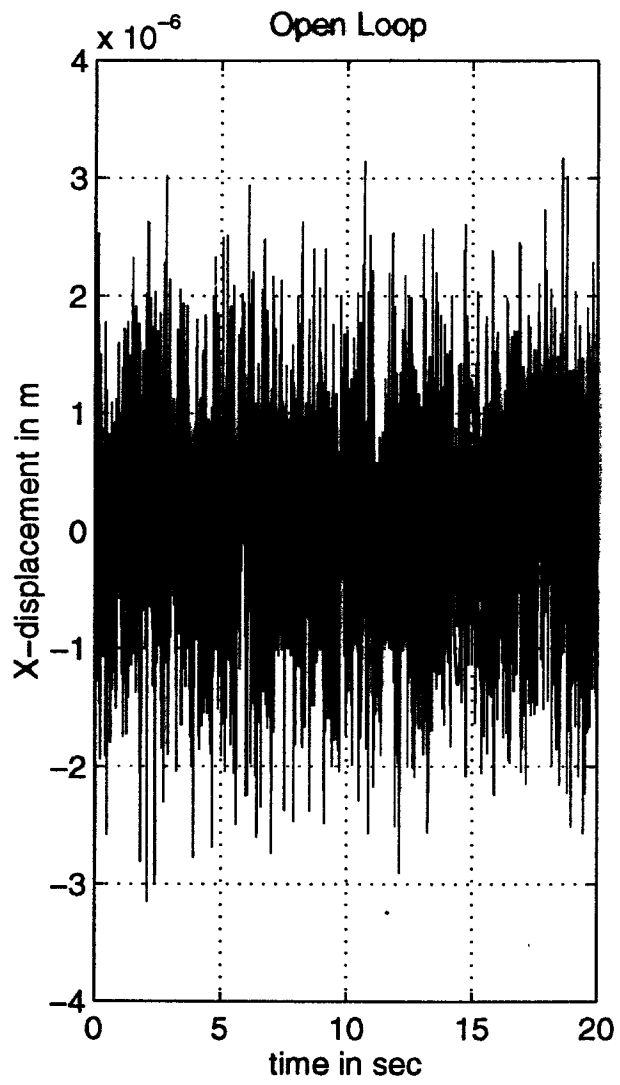

Closed Loop Transfer Function

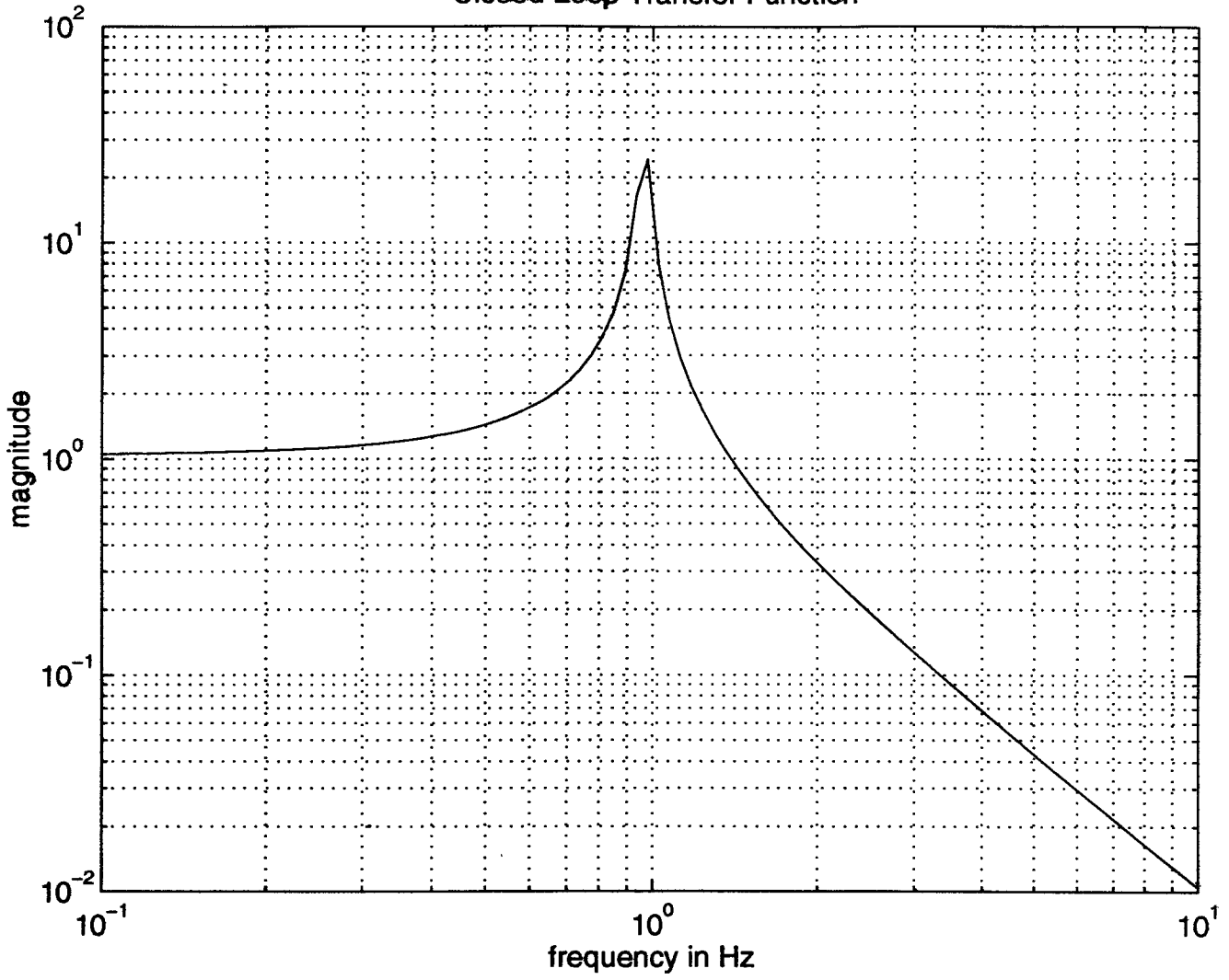

Data Analysis System White Paper

A. Lazzarini



LIGO Data Analysis System

White Paper Overview

A.Lazzarini

22 May 97

LIGO Science & Integration Meetings
Pasadena, CALIFORNIA



LIGO Data Analysis System

White Paper

- Conceptual approach to providing data analysis capability for LIGO I
- Factors in the need to provide access to data for the Collaboration
- Identifies how off-line resources can be made available
- Identifies on-line and off-line analyses
- Lays out the foundations of software design/implementation choices
- Lays out how sites & universities will communicate



DAS Conceptual Approach

on line component

- Provide adequate on-line capability to support sites independently
 - ›› Process GW datastream (suitably conditioned) for chirp detection
 - Lower detectable mass limit set by resources
 - $m > 1 M_{\text{SUN}}$ IS ACHIEVABLE WITH 3.6 GFLOPS/INTERFEROMETER
 - 2KM & 4KM MACHINES REQUIRE DIFFERENT TEMPLATE DICTIONARIES
 - USE THE CDS/DAQ MASS STORAGE ARRAY (AUGMENTED, IF REQUIRED) FOR CACHE SPACE AT THE SITES - 400 GB
 - storage of 9 hours of 100% data stream
 - storage of 10 weeks of GW channel only
 - ›› Process GW datastream for transient (burst) events
 - site-to-site datastream cross-correlation for short periods of time
 - ›› Provide for WAN access to data for university analyses
 - Analyses performed locally on workstation cluster (cannot bog down on-line system) or remotely by transferring data blocks (compressed)
 - ›› During commissioning system will be used ^(mainly) for diagnostics
 - ›› Utilize template filter bank performance as an end-to-end machine performance metric
 - Noise statistics
 - False alarm rate
 - Drift in sensitivity
 - etc.

Block diagram of the On-line DAS for inspiral chirp detection

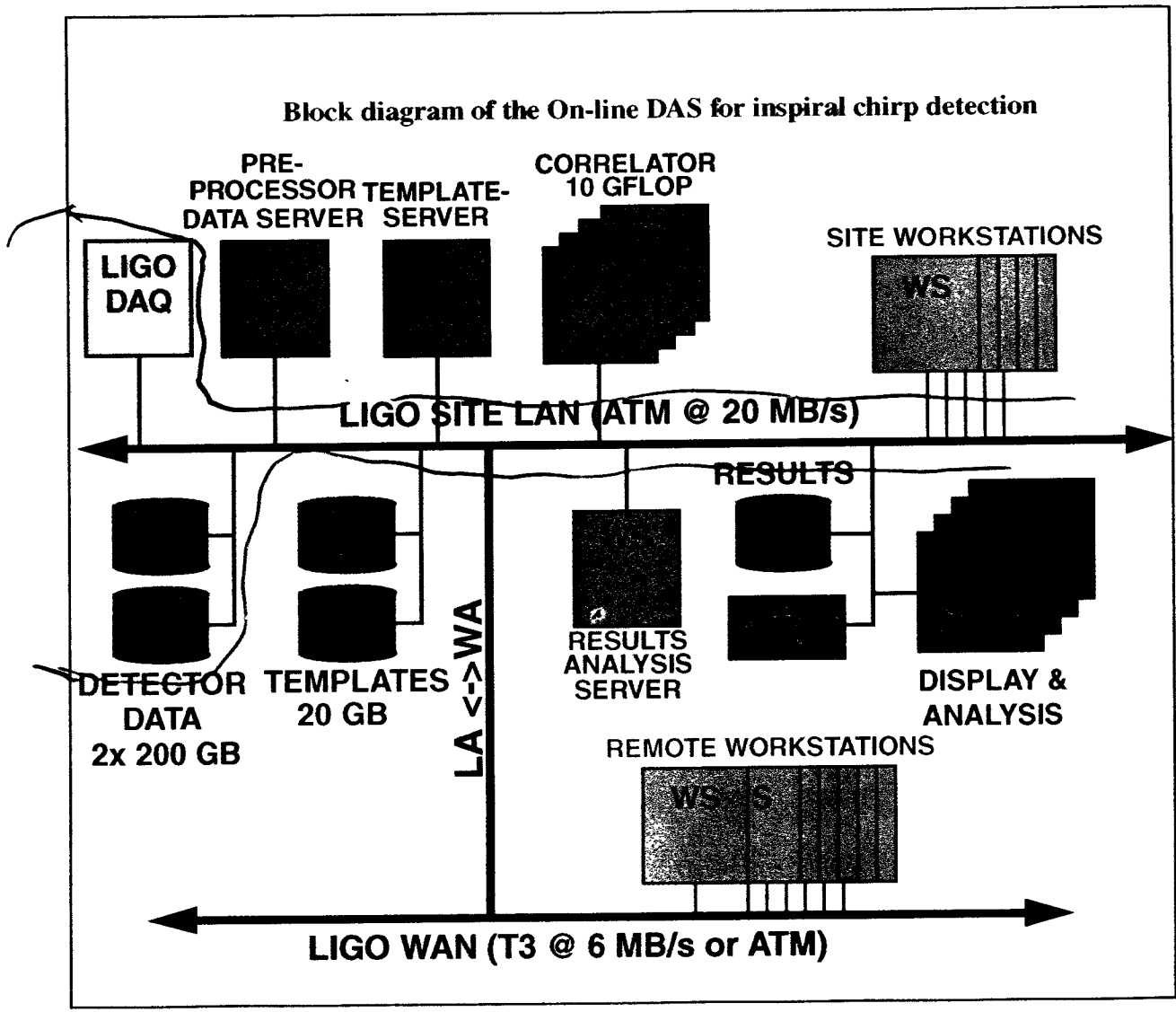

Minimum detectable mass (solar mass) versus computer processing power (GFLOPS) for two interferometers operating simultaneously (Hanford site)

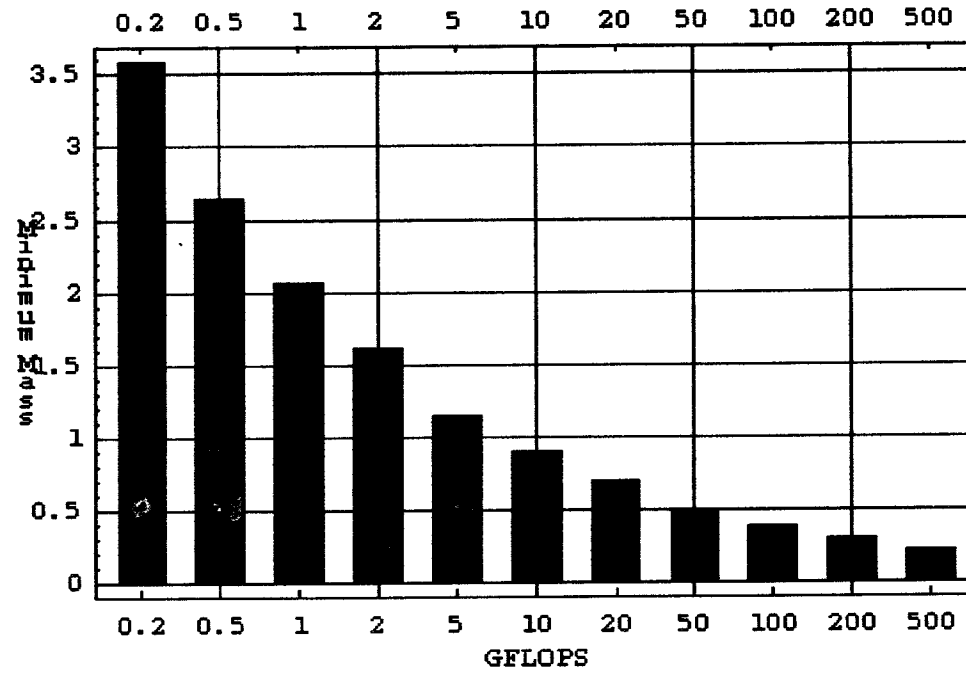

DAS Conceptual Approach

off line component

- Off-line capability provided through CACR
 - >> data archive (secondary backup @ SDSC?)
 - >> reduction of datasets
 - final calibration
 - cross-correlation with other channels
 - regression (if needed)
 - dewatering
 - compression
 - data QA flags
 - >> high bandwidth access by remote researchers
 - LIGO Laboratory: MIT, Hanford, Livingston
 - Scientific Collaboration: UMW, UO,...
 - >> CACR hosts analyses and provides results
 - inspiral searches to lighter binary masses
 - periodic source searches
 - **INITIALLY DIRECTED AT SPECIFIC TARGETS**
 - other analysis techniques
 - >> connectivity via Wide Area Network
 - >> model for interaction and research with CACR being formed through experience with prototyping activities

DAS Conceptual Approach software

- Long term support of LIGO laboratory requires cost effective solution to code support
- Standardization improves maintainability
 - ›› Choice of language: (C/C++/JAVA(?))
 - ›› ensure code can migrate across platforms (newer/different)
 - upgrades
 - new collaborators
 - ›› Object oriented design
 - steeper development curve - need to specify/design
 - easier maintenance cycle - objects constitute “building blocks” of which other objects are composed
 - ›› Standardized style -readability/documentation/format
 - ›› Standardized data format allows exchange of data
 - choice is result of compromise to maintain compatibility with VIRGO and result of internal trade study looking at commercial and scientific (NASA) image-based formats
 - LIGO has begun to use frames *first* and is discovering needed improvements - working closely with VIRGO
 - ›› UNIX platforms will be used (SUN/IBM/SGI/HP-CONVEX)
 - ›› parallelized code will be standardized to MPI
 - available for massively parallel supercomputer
 - available for workstation clusters

DAS Conceptual Approach

Modeling tools

- Model software design predicated on same design philosophy as analysis code
 - ›› evolve on-going effort for 40 end-to-end model into LIGO model
 - map as closely as possible model objects -> hardware elements
 - C++ design
 - extensible to other interferometer configurations (supports adv. r&d)
 - ›› pseudo data created by simulation will be output in frame format to permit easy incorporation into analysis software
 - ›› advanced R&D collaborators wishing to develop model enhancements will be able to contribute to final product



DAS Conceptual Approach

Data Analysis Tools/Environment

- Analyses are process flows
 - ›› Data (time series, e.g.) are processed by methods to create results
 - Calibration/dewhitening/regression/filtering/cross-correlation/ etc.
 - Results may be visualized/displayed using any environment
 - **DATA PROCESSING PRODUCTS WILL HAVE A STANDARD FORMAT**
 - **spectra**
 - **event lists**
 - **time series**
 - **etc.**
 - ›› Present emphasis is mostly on prototyping methods and code development:
 - GRASP (Gravitational Radiation Analysis and Simulation Package).
 - development proceeding as a collaborative effort among interested, dedicated researchers (LIGO, CACR and collaborators)
 - database development of LIGO data - web access to prototype datasets
 - benchmarking of software on various platforms
 - **SUN cluster**
 - **PC cluster w/ high speed switch (BEOWULF)**
 - **IBM SP2**
 - **Paragon**
 - **etc.**



DAS Conceptual Approach

Data Analysis Tools/Environment

- ›› Structure of the analysis libraries, etc. being designed/defined through experience
 - Elements of prototype code (GRASP) will be incorporated as C++ objects
 - CVS (Concurrent Version Control) for managing evolution of code

- ›› User interface to analysis tools being prototyped as a web-browser front-end -- Prototype: PARAFLOW
 - User sees a “Netscape”-like paradigm -- internet access
 - Developed on a paradigm already in use by JPL/Caltech for NASA (SAR) database.
 - User may either use a command window or graphical interface (GUI)
 - **Analysis process is specified via building blocks (similar to MATLAB paradigm)**
 - **Linkage of processes implies an MPI script which is built on remote machines (@ CACR)**
 - Analysis flows implement elements of GRASP-like modules or can be researcher-provide for her own analysis
 - **THERE WILL BE AN INTERFACE TO ALLOW USER TO PORT/DOWNLOAD HER CODE TO CACR FOR COMPILATION/DEBUGGING/IMPLEMENTATION INTO ANALYSIS FLOW**

- ›› Database accessed automatically via a High Performance Storage System (disk cache + tape robot system)

DAS Conceptual Approach

Data Analysis Tools/Environment

- ›› Which machines are used for a particular analysis is transparent to user
 - uses heterogeneous parallel computing using Message Passing Interface (MPI) standard
 - resource scheduling/configuration/etc. is handled by the interface
 - resources may be geographically separated.

- ›› Users wishing to download raw data to local resources may do so -- *at their own peril*:
 - internet bandwidth limitations
 - implementing analysis environment on own machines not readily supportable by Laboratory
 - etc....

Data analysis conceptual flow: binary inspiral and coalescence events

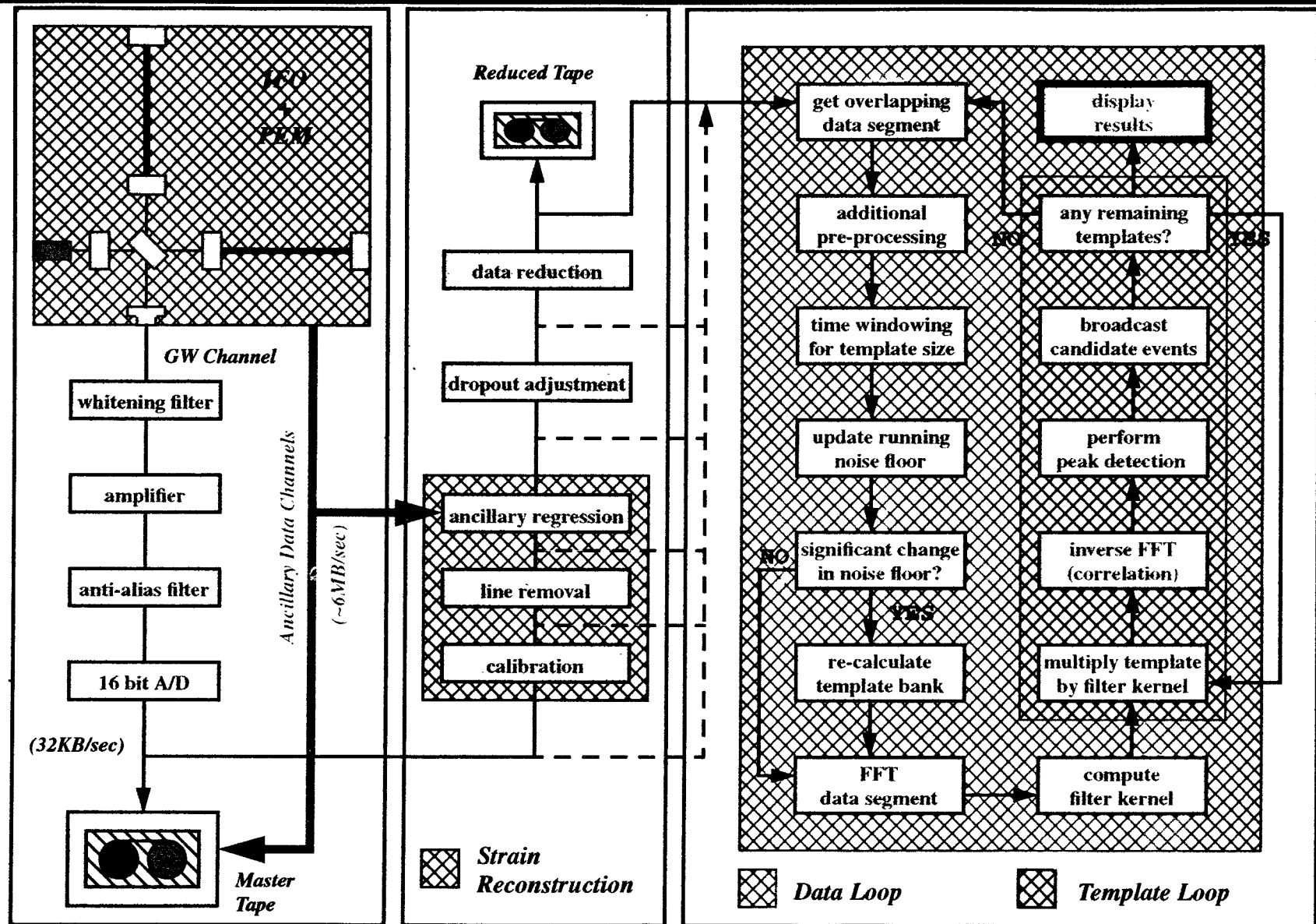

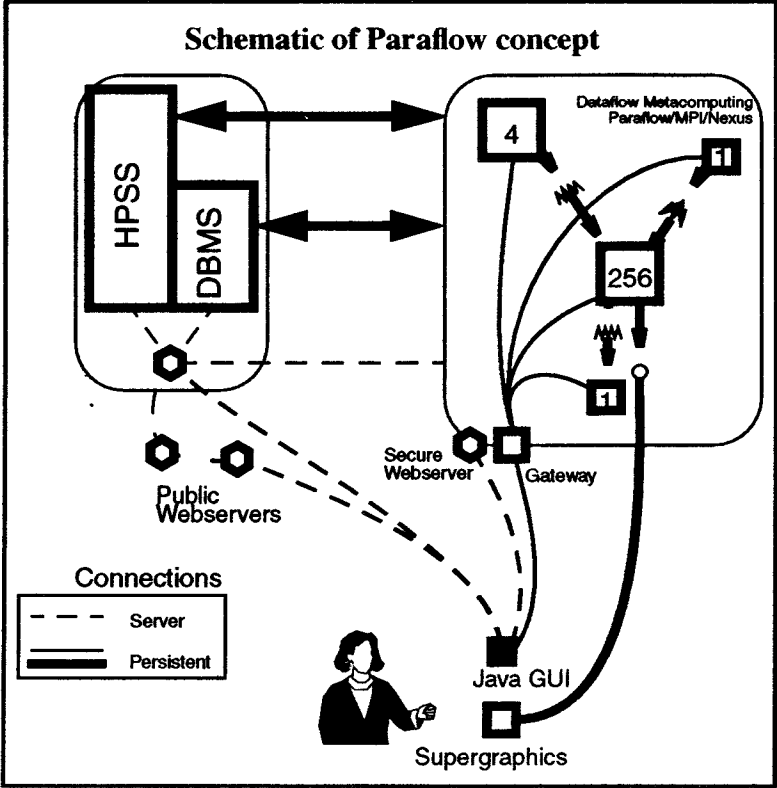

LIGO Wide Area Networks

- Baseline approach is to utilize, wherever possible, the future NSF vBNS backbone:
 - ›› Institutions are proposing inclusion within the network:
 - MIT
 - Caltech (NPACI/CACR)] *granted 22.5.97*
 - LSU - Livingston, use site proposal/MOU provisions to gain access to university resources
 - UMW, ..., etc. - *granted (Madison 22.5.97)*
- LIGO/Hanford will be connected through ESnet (DOE counterpart to vBNS)
 - ›› Link through Battelle/Pacific Northwest National Laboratory (PNNL)
 - ›› Provision in DOE/NSF MOU establishing Hanford Site
 - ›› ESnet links PNNL to LBNL/LLNL -> SLAC -> Caltech (HEP)
 - ›› PNNL may obtain vBNS access directly through its NPACI participation
- Hanford-Livingston connection is via Caltech (possibly MIT as a backup?) if ESnet is used.

NSF's vBNS Infrastructure will allow LIGO Livingston to link up with other Laboratory Sites via NCSA and Louisiana's regional access via SEPSCoR to vBNS (added to map; NSF map is from mid 1996)

The National Science Foundation Very-High-Speed Backbone Network Service Logical Network Map

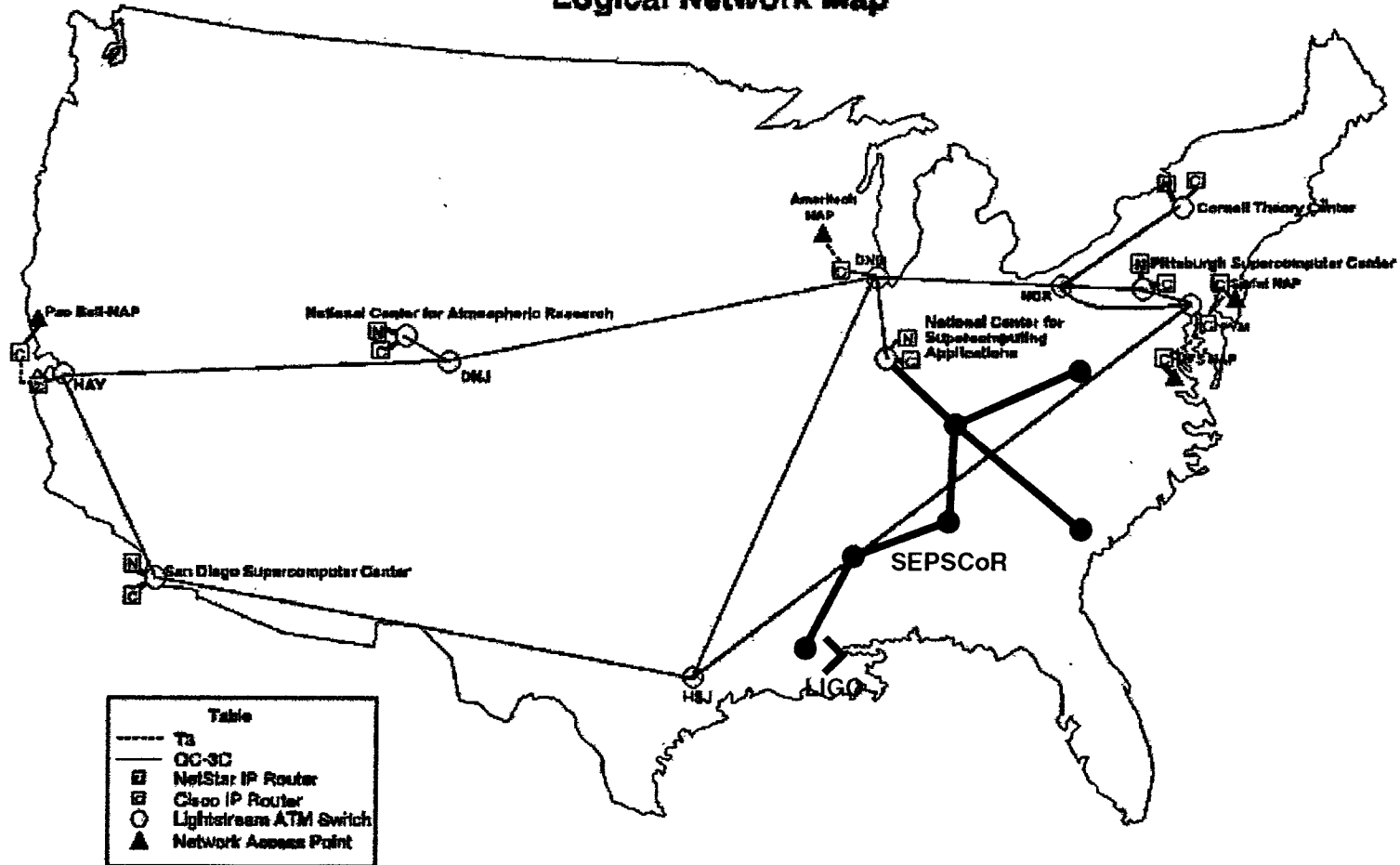

What We've Learned About "FRAMES"

K. Blackburn



What We've Learned About "FRAMES"

*Kent Blackburn
Science & Integration Meeting
LIGO Project
California Institute of Technology
May 22, 1997*

LIGO-G970135-00-E

What are FRAMES...

- *FRAMES are sequentially ordered units of data*
- *Each FRAME has fixed time length*
- *FRAME holds all descriptive data from IFO*
- *Hierarchical organization of data into C structures*
 - *FRAME uses evolving Dictionary to understand content*
- *Various C structures used for different data types*
 - *Fast ADC, Slow ADC, Static, Detector, ...*
- *Arbitrary number of FRAMES stored in files*
- *Single representation of static information per file*
 - *Calibration, State Vector, ...*

Thursday, May 22, 1997

LIGO-G970135-00-E

2

LIGO's Use of FRAMES...

- One year of experiences with FRAMES
- Nov., 94 Dataset from 40m converted to FRAMES
- LIGO using FRAMES in new 40m DAQ System
- May, 1997 40m data runs used FRAMES
- Real-time data visualization possible with FRAMES
- GRASP data analysis of FRAMES both on/off line
- FRAME development benefits from support of 40m data runs, CDS DAQS prototype and GRASP analysis

Thursday, May 22, 1997

LIGO-G970135-00-E

3

FRAME I/O Library Background...

- FRAME software library originated with VIRGO
- Author: Benoit Mours, Annecy France (LAPP)
- LIGO investigated many formats (HDF, CDF, FITS, etc.)
- Proposed as common format for LIGO and VIRGO
 - VIRGO visits LIGO at Annecy & Caltech in April, 1996
 - LIGO began working with library ~ 1 month later
 - Suggestions for major enhancements made by LIGO in July, 96
 - GEO becomes interested in the FRAME format in July, 96
 - TAMA becomes interested in FRAMES at GWDAW in Dec., 96
- Prototype 40 meter DAQS targeted using FRAMES

Thursday, May 22, 1997

LIGO-G970135-00-E

4

FRAME I/O Library Status...

- **First LIGO/VIRGO FRAME distribution May, 96**
 - Several minor revisions made to CDS
 - V2.2 distributed in Jan., 97
 - V2.3 & V2.33 distributed in May, 97 (Current version 1 day old)
 - Software now publicly available on the web (<http://lapphp.in2p3.fr/virgo/FrameL>)
- **FRAME Library software complex**
 - software written with roughly 5200 lines of C code
 - supports big-endian and little-endian integers and IEEE reals
 - supports 17 different C-Structures
 - functionality controlled by 147 C-Functions
- **Versions 2.2 and 2.3 include a FRAME document**

Thursday, May 22, 1997

LIGO-G970135-00-E

5

Collaborative Results...

- **Working together, LIGO and VIRGO have made progress towards a common data format**
- **The FRAME format can deliver the needed data throughput for LIGO**
- **A common data format has been embraced by the gravitation wave detector community**
- **The FRAME format carried from concept to example, from acquisition to analysis**

Thursday, May 22, 1997

LIGO-G970135-00-E

6

Present Issues...

- *Memory-leaks in FRAME library limits run-times*
- *Long turnaround times for fixes and improvements*
- *Coding Standards inadequate for maintaining*
- *Documentation and Examples less than minimal*
- *Formal FRAME Specification missing*
- *More expertise with FRAME software needed*
- *More experience with FRAME data analysis needed*
- *Avenue for partnership code development needed*

Thursday, May 22, 1997

LIGO-G970135-00-E

7

How to Proceed...

- *Frame development limited by Benoit Mours' visits*
 - *Caltech: July, 96 - Initial meeting to specify common format goals*
 - *Caltech: April, 96 - Focus on bugs found in DAQS implementation*
- *Code Support*
 - *Establish faster turnaround to debug reports and extensions*
 - *Establish an in-house FRAME expert to existing code*
- *Lazzarini & Blackburn to visit Benoit Mours*
 - *Improving coding standards, documentation and specifications*
 - *Implement code configuration management tools*
- *LIGO may need tighter control of FRAMES*
 - *Should LIGO become the official developer of the FRAMES?*

Thursday, May 22, 1997

LIGO-G970135-00-E

8

GRASP Overview

B. Allen



Science Integration Meeting, May 22, 1997

GRAVITATIONAL RADIATION ANALYSIS
AND SIMULATION PACKAGE (= GRASP)

- Problem: Most data analysis techniques/ideas developed theoretically *but not studied on real GW-detector data.*
- Solution: Use 45 hours of data from November 1994, and forthcoming 40-meter prototype data.
- Purpose: Test-bed for prototyping data analysis techniques.
 - Implement/document “benchmark” algorithms (example: Wiener matched filtering for binary inspiral detection)
 - Comparison of different algorithms (example: Wigner-Ville vs. Wiener)
 - Answer specific technical questions (example: effects of quantization error on binary inspiral search)
 - Provide means for others (including those “outside” the LIGO project) to see & experiment with real data (example: Thorne’s group)
 - Popularize/Illustrate the FRAME data format.
- Form: A portable function library (Posix/ANSI C) with extensive documentation, and example programs to illustrate the different functions. Works on Sun, Dec, HP, Linux, SP2, Paragon. Only requirements are either public domain (i.e. *xmgr*) or inexpensive (i.e. *Numerical Recipes*).

Some quotes:

- Jon Bentley, *Writing efficient programs*: “Prototype, prototype, prototype!”
- Fredrick C. Brooks, *The mythical man-month*, “Plan to throw one away; you will, anyhow.”
- Franklin Roosevelt, “It is common sense to take a method and try it. If it fails, admit it frankly and try another. But above all, try something.”

HOW IS GRASP ORGANIZED?

The organization of GRASP is hierarchical, closely paralleled by the manual:

- **Introduction:** Purpose, quick start, hardware/software requirements, installation, file structure, conventions.
- **40-meter data:** Data format, reading routines. Examples include:
 - reading blocks
 - finding locked sections
 - animation of data/power-spectra
 - printing swept-sine calibration curves
 - animated & calibrated power spectra
 - sonogram diagnostics
- **Binary inspiral:** 2nd PN-order chirp generation, chirp-filter production, Wiener filtering, orthonormalization of filters, convolution of chirps with detector response function, injection of chirps in time/frequency domain, vetoing techniques, setting up template grid in parameter space, optimal filtering through a single template, optimal filtering through template grid. Examples include:
 - plotting chirp
 - constructing filter set
 - optimal filtering through a single (pair of) filters
 - area of parameter space
 - constructing grid of templates
 - plotting template grid
 - optimal filtering through template bank covering $m_1 \rightarrow m_2$ (MPI).
- **Stochastic BG:** Detector site location/orientation, overlap reduction function, simulated detector noise production in time domain (arbitrary whitening/dewhitening), simulated correlated stochastic background production, optimal correlated filtering, statistical analysis for stochastic background. Examples include
 - plotting overlap reduction function for any detector pair
 - simulated detector noise & SB at two sites
 - plotting optimal filter for SB detection

- determining (theoretically-expected SNR) after integration time T
- predicting integration time necessary to observe background of given intensity Ω
- Monte-Carlo simulation of analysis pipeline
- **General-purpose:** time-averaged power spectra, histogram binning, robust outlier detection, graphing routines (using `xmgr`), audio/sound routines, multitaper window function, multitaper spectra, spectral line identification, spectral line removal, interface to frame library. Examples include:
 - translator from November 1994 40-meter format to FRAME format
 - removing “spectral lines” from Willamette river data
 - identifying/removing spectral lines from “raw” 40-meter output
 - tracking line harmonic/violin mode frequency, phase, amplitude

All examples work on *either* FRAME format data or on November 1994 data (though the latter is planned to become obsolete).

This talk: show some examples from GRASP, lessons learned; discuss future work & questions that need further investigation.

EXAMPLE - animate program

This example displays a window showing the raw IFO output in real time and its spectrum in real time.

```
animate | xmgr -pipe
```

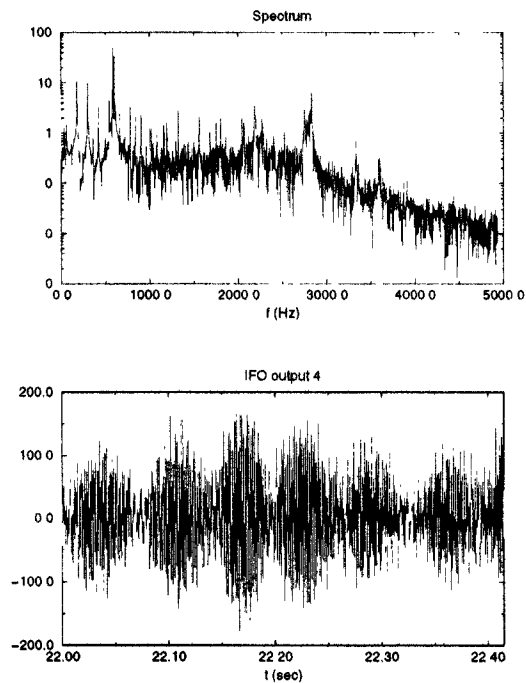

One of the interesting things that I found was that after the instrument comes into lock, the output is *zero* (up to DC offsets). The explanation: the SR output amps are saturated when the instrument is out of lock. Because they are AC-coupled, the IFO channel is zero. After coming into lock (unless someone presses the reset button!) the amplifiers take from 5 to 30 seconds to come out of saturation which provides a non-zero IFO output.

CALIBRATION

The calibration of the instrument is stored in swept-sine calibration files (801 line ascii files containing 3 columns: frequency, real, imaginary). GRASP includes a function which returns $R(f)$, defined by

$$\widetilde{\Delta l} = R(f) \times \widetilde{C}_{\text{IFO}} \quad \text{with} \quad R(f) = \frac{Q \times \text{ADC}}{-4\pi^2 f^2 S^*(f)}.$$

Here “tilde” denotes Fourier transform and C_{IFO} is the IFO differential-mode output, channel 0.

Description	Name	Value	Units
Gravity-wave signal (IFO_DMRO)	C_{IFO}	varies	ADC counts
A→D converter sensitivity	ADC	10/2048	$V_{\text{IFO}} (\text{ADC counts})^{-1}$
Swept sine calibration	$S(f)$	from file	$V_{\text{IFO}} (V_{\text{coil}})^{-1}$
Calibration constant	Q	1.428×10^{-4}	meter $\text{Hz}^2 (V_{\text{coil}})^{-1}$

Table 1: Quantities entering into normalization of the IFO output.

$$Q = \frac{\sqrt{9.35 \text{ Hz}}}{k} = 1.428 \times 10^{-4} \frac{\text{meter Hz}^2}{V_{\text{coil}}}, \quad \text{with } k = 21399 \frac{V_{\text{coil}}}{\text{meter Hz}^{3/2}}.$$

One of the interesting things I found was that there was no documentation showing the phase conventions. In other words, did imaginary part positive mean that the phase was leading or lagging? Eventually Bob and I did a simple experiment with an RC circuit to establish the phase conventions.

EXAMPLE - calibrate program

This program produces a (calibrated!) time-averaged power spectrum, making use of the response function $R(f)$.

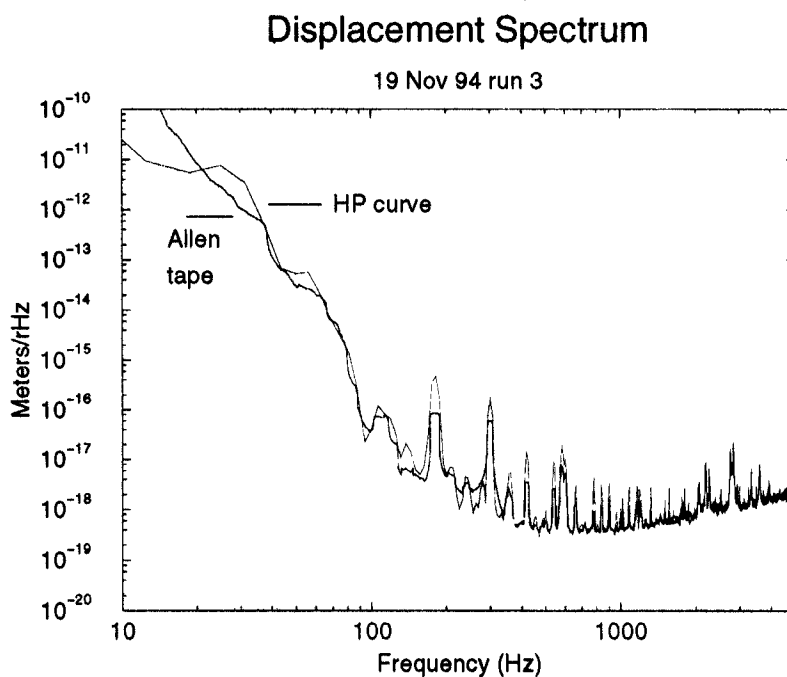

Figure 1: An example of a power spectrum curve produced with `power_spectrum`. The spectrum produced off a data tape (with 100 point smoothing) is compared to that produced by the HP spectrum analyzer in the lab.

This was the first time that anyone had used the data on tape to produce a calibrated power spectrum – prior to this the only calibrated spectra had come off the HP signal analyzer in the 40-meter lab.

EXAMPLE - diag program

This is a simple time-frequency diagnostic tool.

Thu May 8 22:37:42 1997

Time/Frequency statistics (aliasing?)

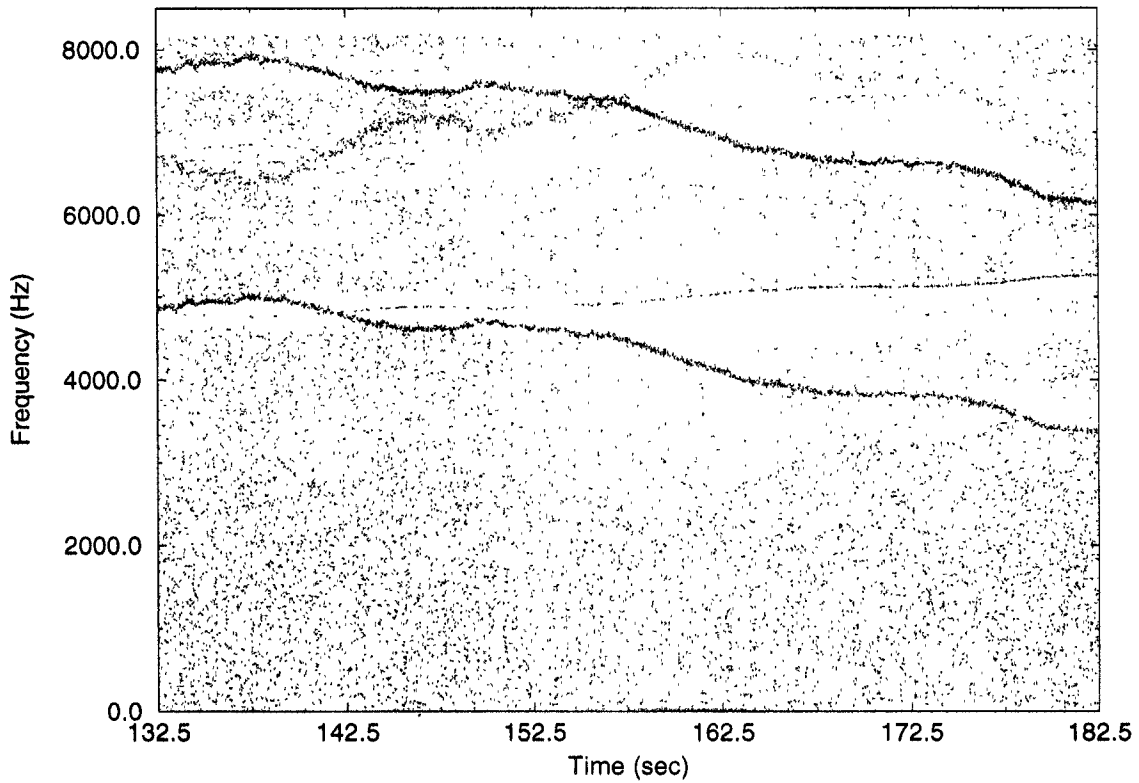

- Detects fluctuations away from mean variance in power spectrum (exponentially-decaying moving average).
- Graph above reveals aliasing in the DAQ system (PZT signal).

Fri May 9 15:14:47 1997

Time/Frequency statistics (aliasing test)

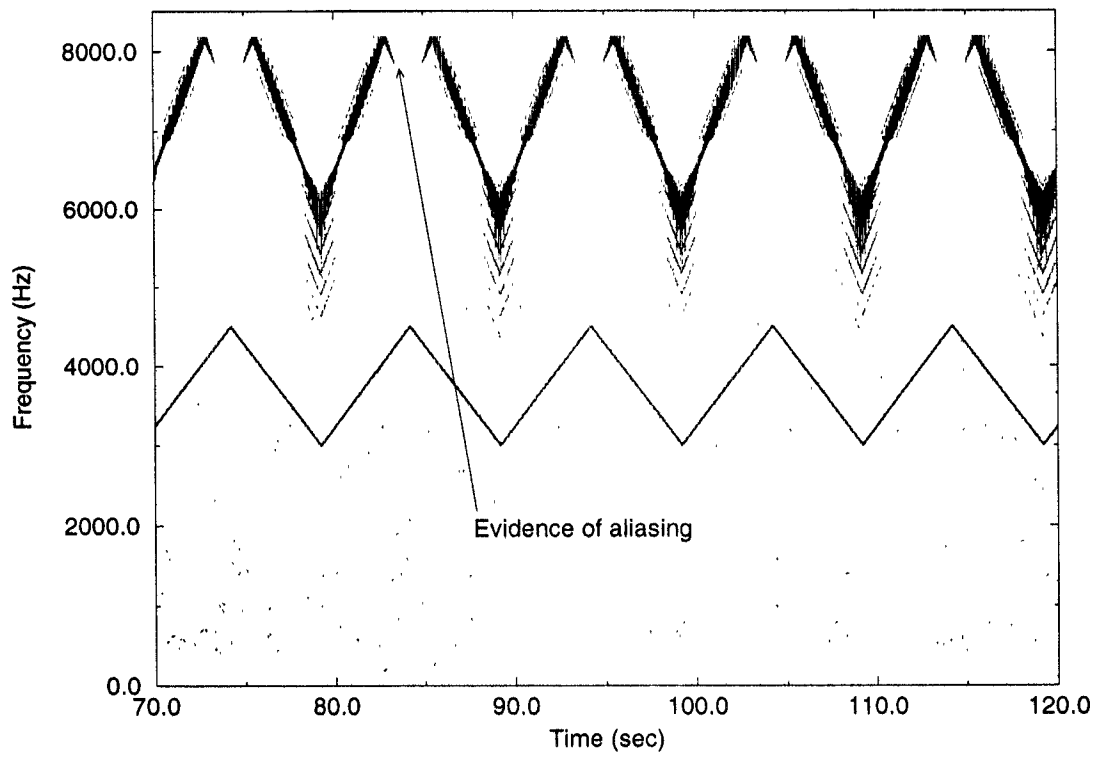

EXAMPLE - filters program

This is a program which was written in collaboration with Alan Wiseman. It produces properly-normalized binary inspiral chirps.

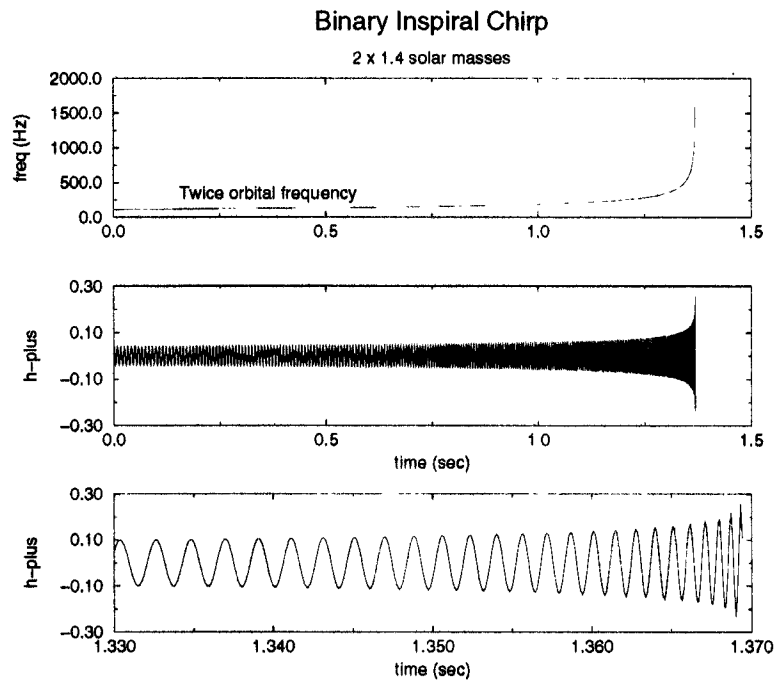

- Post-Newtonian corrections (optionally) included up to second order in amplitude and/or phase.
- Warns user of a variety of different error conditions.
- Automatically terminates chirp when post-Newtonian approximation or other assumptions no longer hold.

Plans for 40 Meter Data Analysis

On-line Analysis: (Time-Frequency Method)

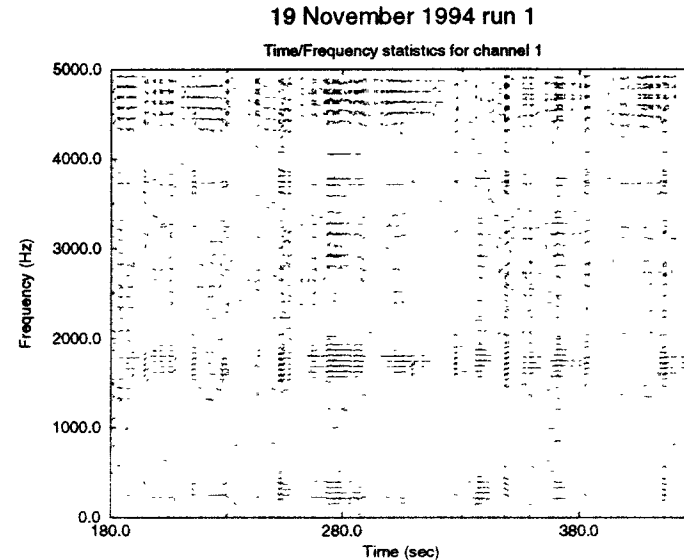
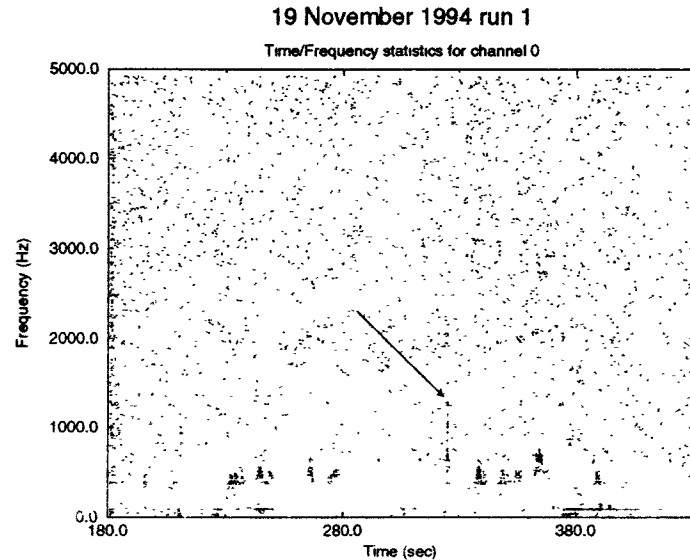

- Exponentially weighted running power spectrum
- Gravitational wave channel on left
- Coincident magnetometer channel on right
- Provides useful detector diagnostics
- Allows non-Gaussian noise characterization

EXAMPLE - optimal program

This is a program which filters IFO output through a single binary inspiral template – in this case chosen to be 2×1.4 solar mass objects.

```
...
max snr: 3.11 offset: 23623 data start: 180.00 sec. variance: 0.94044
max snr: 2.91 offset: 3311 data start: 185.17 sec. variance: 0.84484
...
max snr: 2.53 offset: 19041 data start: 309.26 sec. variance: 0.70333
max snr: 2.98 offset: 35711 data start: 314.43 sec. variance: 0.67523
max SNR: 8.71 (offset 42109) variance 0.805030
  If impulsive event, offset 55624 or time 325.23
  If inspiral, template start offset 42109 (time 323.86) coalescence time 325.23
  Normalization: S/N=1 at 116.75 kpc
  Linear combination of max SNR: 0.9315 x phase_0 + 0.3638 x phase_pi/2
  Less than 1% probability that this is a chirp (p=0.000000).
  Distribution: s= 23, N>3s= 12 (expect 176), N>5s= 0 (expect 0)
  Distribution does not appear to have outliers...
max snr: 2.51 offset: 31183 data start: 324.77 sec. variance: 0.63028
max snr: 2.56 offset: 49909 data start: 329.94 sec. variance: 0.66853
...
max snr: 2.82 offset: 35080 data start: 3002.03 sec. variance: 0.77306
max snr: 2.61 offset: 33141 data start: 3007.20 sec. variance: 0.74268
max SNR: 89.75 (offset 16678) variance 82.547005
  If impulsive event, offset 30193 or time 3015.43
  If inspiral, template start offset 16678 (time 3014.06) coalescence time 3015.43
  Normalization: S/N=1 at 128.49 kpc
  Linear combination of max SNR: -0.3955 x phase_0 + 0.9185 x phase_pi/2
  Less than 1% probability that this is a chirp (p=0.000000).
  Distribution: s= 29, N>3s= 157 (expect 176), N>5s= 30 (expect 0)
  Distribution has outliers! Reject
max snr: 3.24 offset: 22412 data start: 3017.54 sec. variance: 0.99474
max snr: 2.73 offset: 37777 data start: 3022.71 sec. variance: 0.75325
...
max snr: 2.80 offset: 5893 data start: 4140.89 sec. variance: 0.73240
max snr: 2.75 offset: 46932 data start: 4146.06 sec. variance: 0.69654
max SNR: 6.08 (offset 30002) variance 0.883380
  If impulsive event, offset 43517 or time 4155.64
  If inspiral, template start offset 30002 (time 4154.27) coalescence time 4155.64
  Normalization: S/N=1 at 113.04 kpc
  Linear combination of max SNR: -0.4773 x phase_0 + 0.8787 x phase_pi/2
  POSSIBLE CHIRP! with > 1% probability (p=0.024142).
  Distribution: s= 31, N>3s= 399 (expect 176), N>5s= 53 (expect 0)
  Distribution has outliers! Reject
max snr: 2.77 offset: 15985 data start: 4156.40 sec. variance: 0.72095
max snr: 2.69 offset: 47338 data start: 4161.57 sec. variance: 0.69708
...
```

The events were rejected because:

Event 1: Failed the frequency-distribution test.

Event 2: Failed the outlier test (and the frequency distribution test).

Event 3: Failed the outlier test (but passed outlier test, barely!)

Data Stream

19 Nov 94 run 1

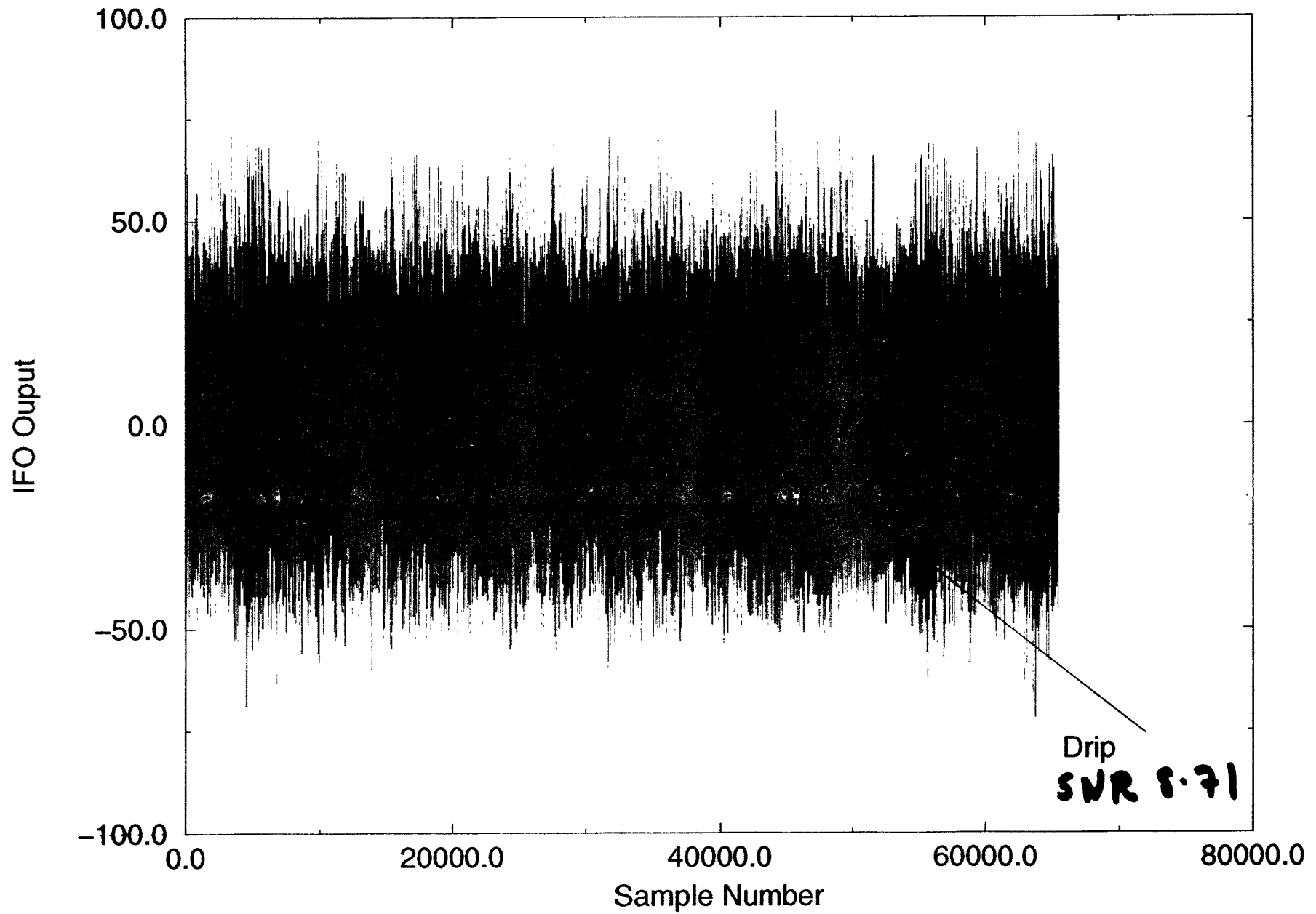

Data Stream

19 Nov 94 run 1

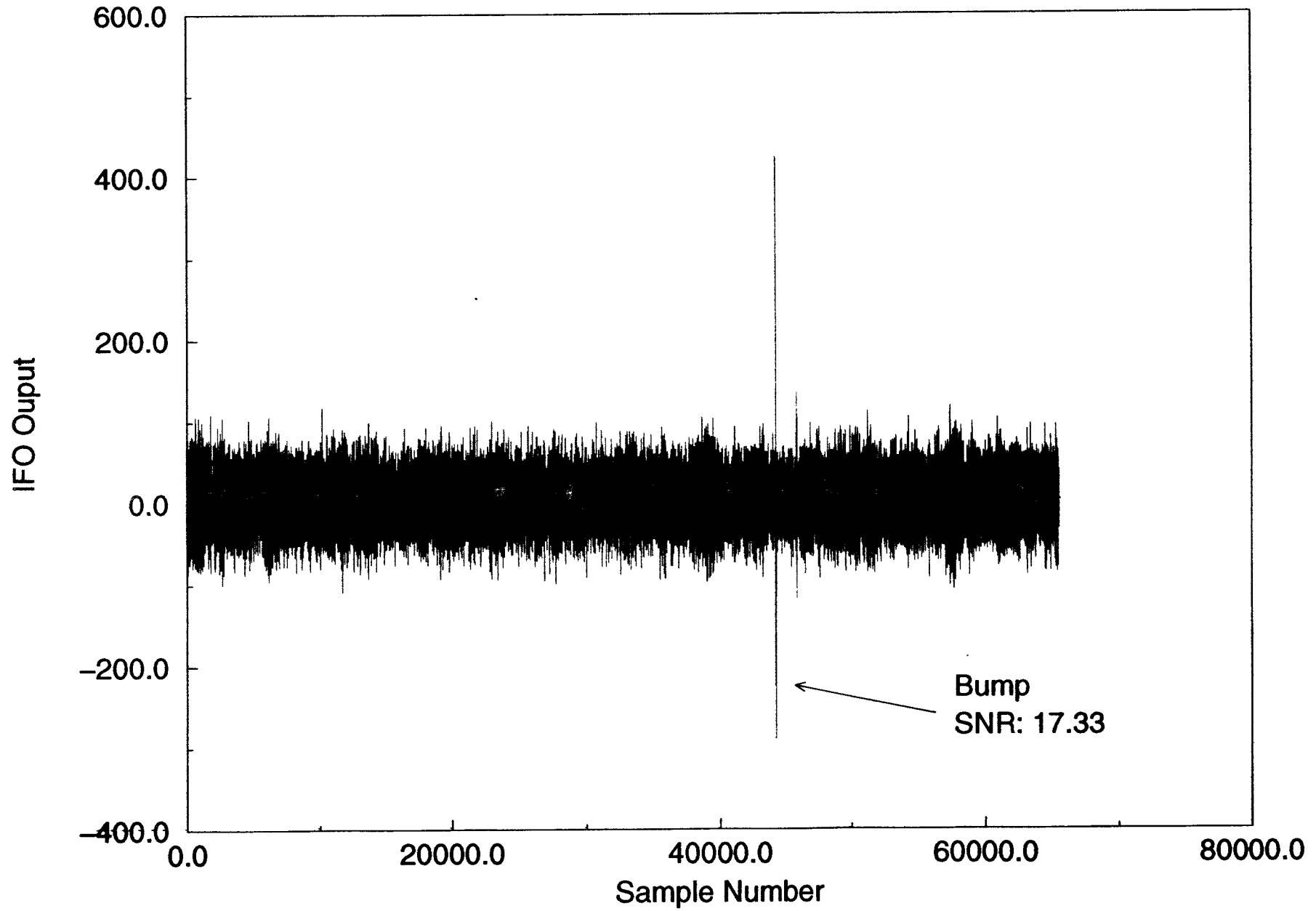

Data Stream

19 Nov 94 run 1

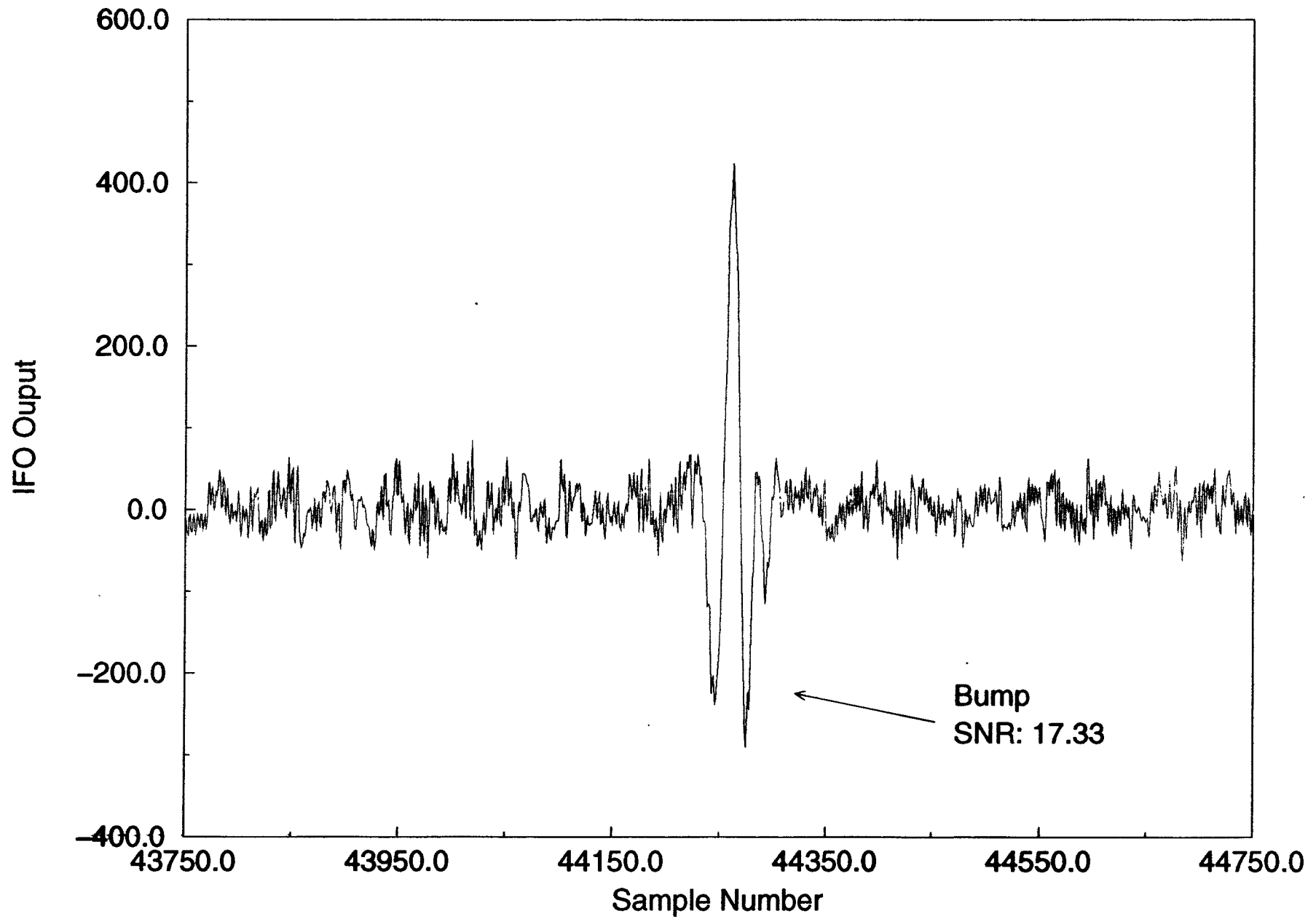

Data Stream

19 Nov 94 run 1

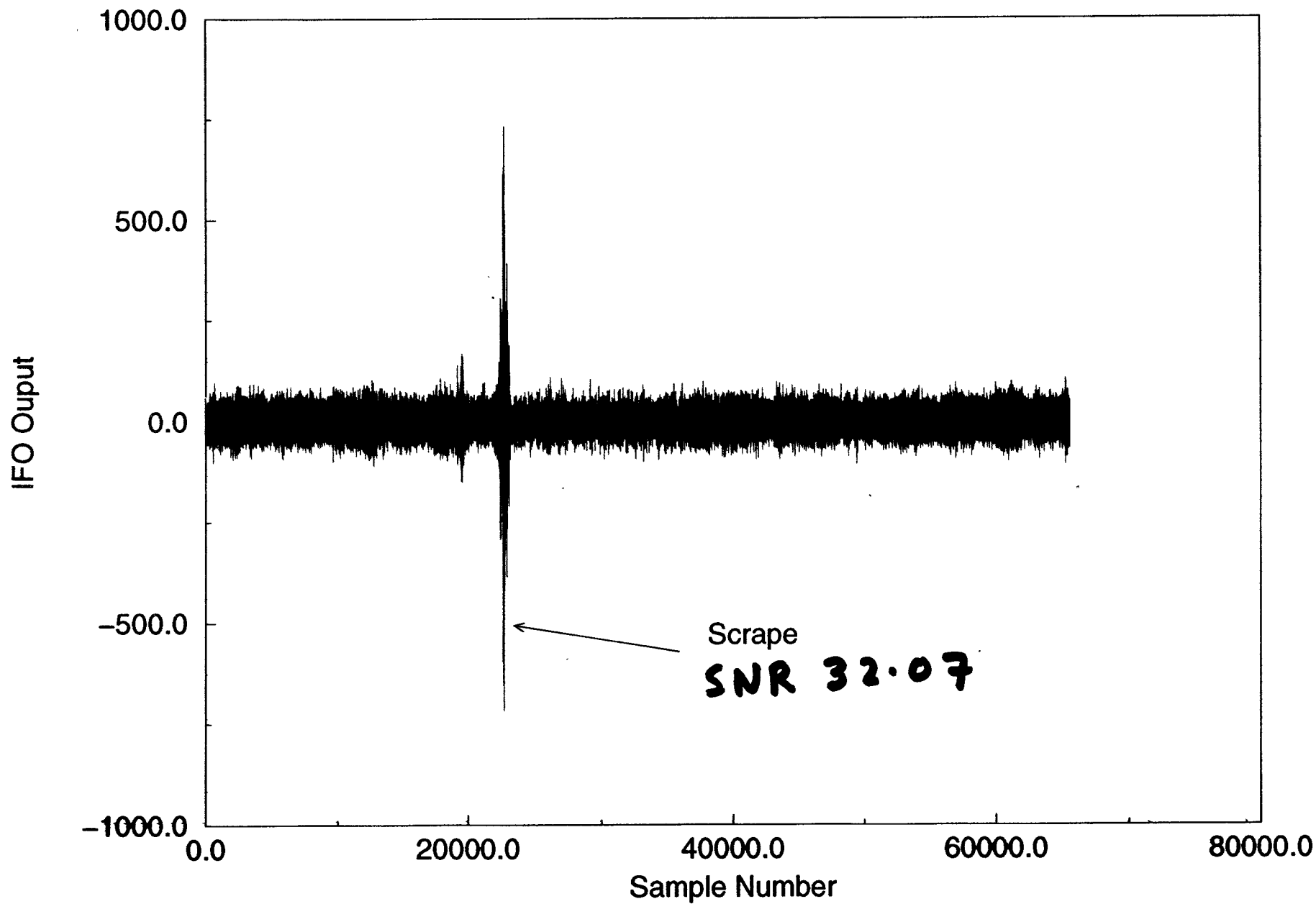

Data Stream

19 Nov 94 run 1

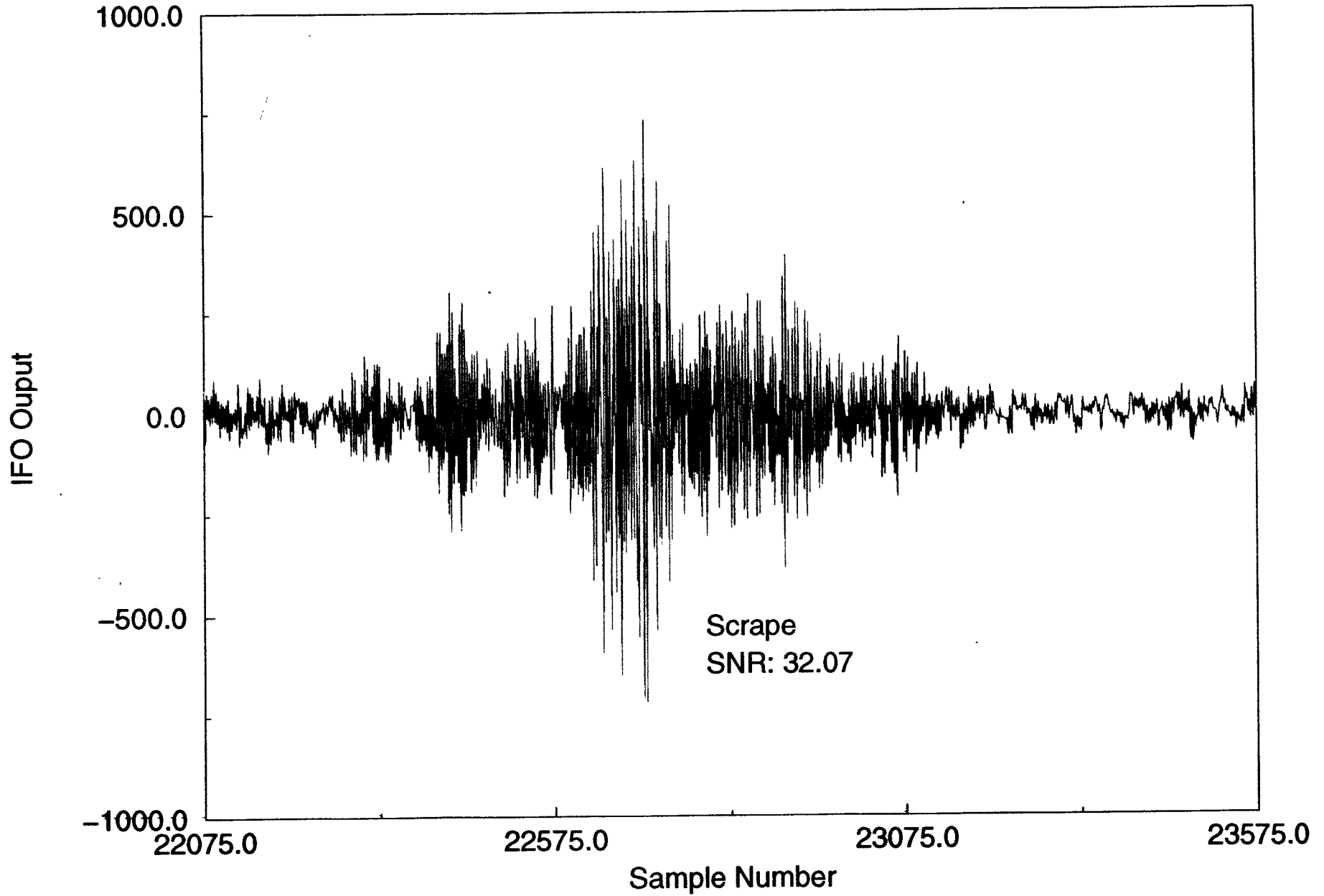

Chirp Injection (in time or freq domain)

```
invMpc_inject=100.0; /* To inject a signal at 10 kpc, set this to 100.0 */  
time_inject(1.0,0.0,12345,invMpc_inject,chirp0,chirp90,data,response,output0,npoint);
```

This produces the following output:

```
...  
max SNR: 9.96 (offset 12345) variance 0.872624  
If impulsive event, offset 25860 or time 187.79  
If inspiral, template start offset 12345 (time 186.42) coalescence time 187.79  
Normalization: S/N=1 at 152.17 kpc  
Linear combination of max SNR:  $0.9995 \times \text{phase}_0 + -0.0304 \times \text{phase}_{\pi/2}$   
POSSIBLE CHIRP! with > 1% probability (p=0.421294).  
Distribution: s= 23, N>3s= 12 (expect 176), N>5s= 0 (expect 0)  
Distribution does not appear to have outliers...  
  
max SNR: 12.84 (offset 12345) variance 0.834527  
If impulsive event, offset 25860 or time 192.96  
If inspiral, template start offset 12345 (time 191.59) coalescence time 192.96  
Normalization: S/N=1 at 132.47 kpc  
Linear combination of max SNR:  $0.9953 \times \text{phase}_0 + 0.0973 \times \text{phase}_{\pi/2}$   
POSSIBLE CHIRP! with > 1% probability (p=0.949737).  
Distribution: s= 22, N>3s= 28 (expect 176), N>5s= 0 (expect 0)  
Distribution does not appear to have outliers...  
  
max SNR: 14.86 (offset 12345) variance 0.801640  
If impulsive event, offset 25860 or time 198.13  
If inspiral, template start offset 12345 (time 196.76) coalescence time 198.13  
Normalization: S/N=1 at 127.90 kpc  
Linear combination of max SNR:  $0.9993 \times \text{phase}_0 + -0.0372 \times \text{phase}_{\pi/2}$   
POSSIBLE CHIRP! with > 1% probability (p=0.999236).  
Distribution: s= 22, N>3s= 35 (expect 176), N>5s= 0 (expect 0)  
Distribution does not appear to have outliers...  
...
```

Conclusion: we can detect chirps in the GW signal, and reject spurious events.

Plans for 40 Meter Data Analysis

Gravitational Radiation Analysis & Simulation Package (GRASP):

Binary Inspiral Template Spacing

$$\tau_0 = \frac{5}{256} \cdot \left(\frac{G \cdot M}{c^3} \right)^{-5/3} \cdot \eta^{-1} \cdot (\pi \cdot f_o)^{-8/3}$$

$$\tau_1 = \frac{5}{192} \cdot \left(\frac{c^3}{G \cdot \eta \cdot M} \right) \cdot \left(\frac{743}{336} + \frac{11}{4} \cdot \eta \right) \cdot (\pi \cdot f_o)^{-2}$$

$$M \equiv m_1 + m_2$$

$$\eta \equiv \frac{m_1 \cdot m_2}{(m_1 + m_2)^2}$$

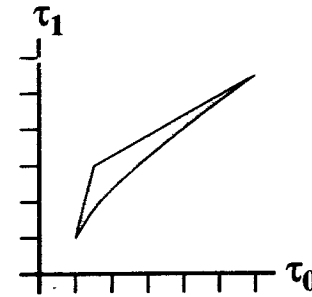
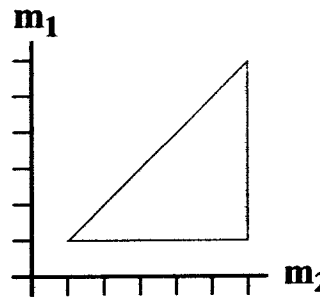
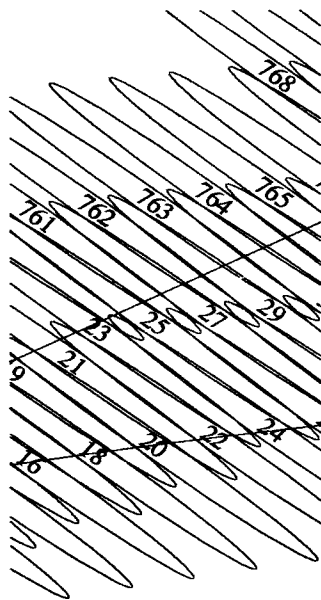

- templates shaped like ellipses in the coordinates of (τ_1, τ_2)
- size and orientation determined by shape of detector noise
- location determined by desired ambiguity (~3% used in figure)
- Nov. 94 40 meter data needs 403 templates, $0.8 \leq (m_1, m_2) \leq 50 M_{\text{sun}}$

EXAMPLE - template_spacing program

This does Monte-carlo testing of a filter template. One injects chirps that are “nearby” in parameter space, and calculates the ambiguity function (the loss of SNR).

Template Coverage

Monte-Carlo simulation

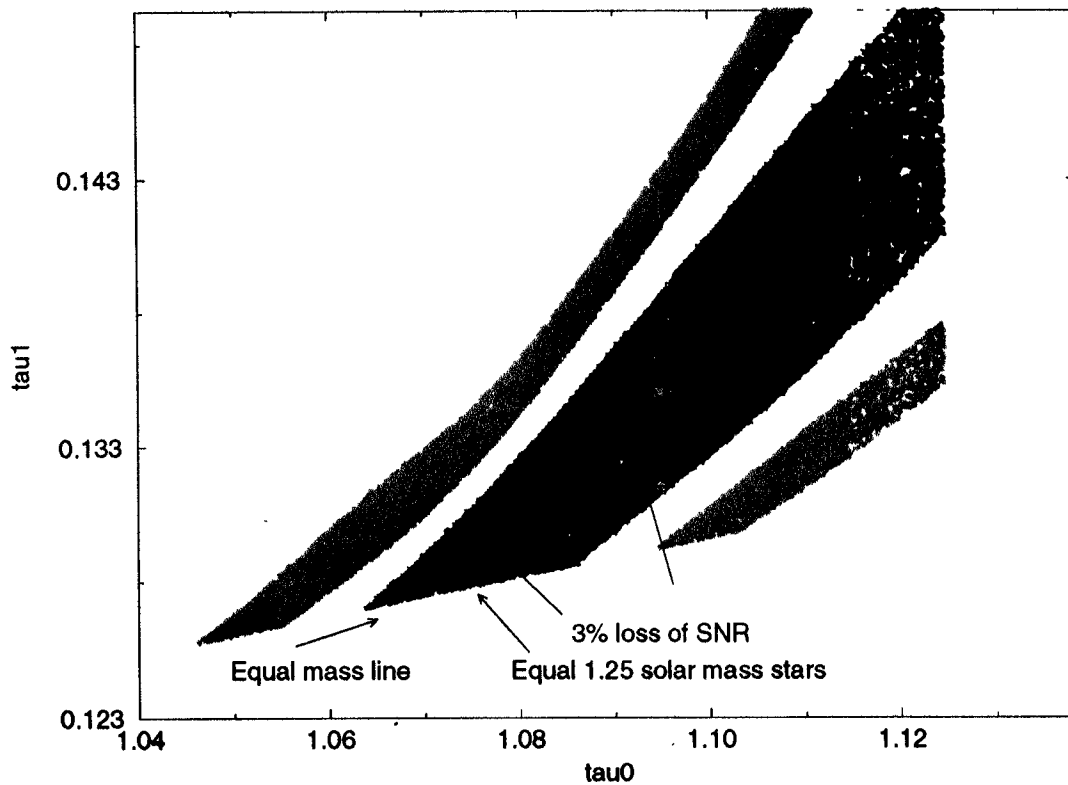

- The region of fixed ambiguity is an ellipse (for small values of 1-ambiguity), as predicted by theory, but...
- the orientation and size of the template ellipse does not appear to agree with theoretical predictions!

EXAMPLE - multifilter

This example program optimally-filters GW data through a bank of filter templates, corresponding to different mass values m_1 and m_2 .

- Using the Message Passing Interface (MPI) library for parallel processing
- Master-Slave model. Master hands out sections of data, slaves process this through filters.
- Master collects and organizes results of filtering (max SNR, veto tests, etc).
- Slaves can save templates or recompute them (depending upon how much memory they have).
- Performance: Running on 256 nodes of the Intel Paragon, it is possible to filter 5 hours of data through 66 templates (representing the mass range from 1.2 to 1.6 solar masses) in $5 \times 3600 \times 66 \times (0.780) / (256 \times 6)$ seconds = 10.1 minutes.

Plans for 40 Meter Data Analysis

Gravitational Radiation Analysis & Simulation Package (GRASP):

Binary Inspiral Optimal Filtering using MPI

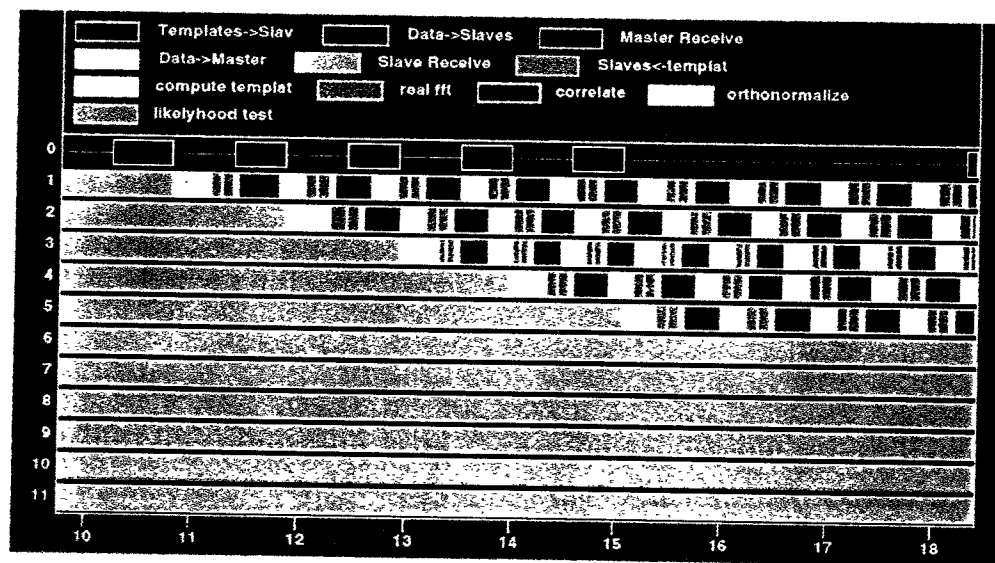

- **optimal filtering code uses the Message Passing Interface (MPI)**
- **MPI provides portability, code tested on SUNs, Paragon and SP2**
- **each node analyzing different date with full template bank used on each node**
- **templates can either be stored and read back or recomputed as needed**
- **spanning 1.2 -> 1.6 solar mass, templates for the Nov. 1994 data needs 66 templates**
- **5 hours of 40 meter filtered by 66 template in 10.3 minutes using 256 nodes on Paragon**

OPTIMIZATION STEPS (Intel Paragon)

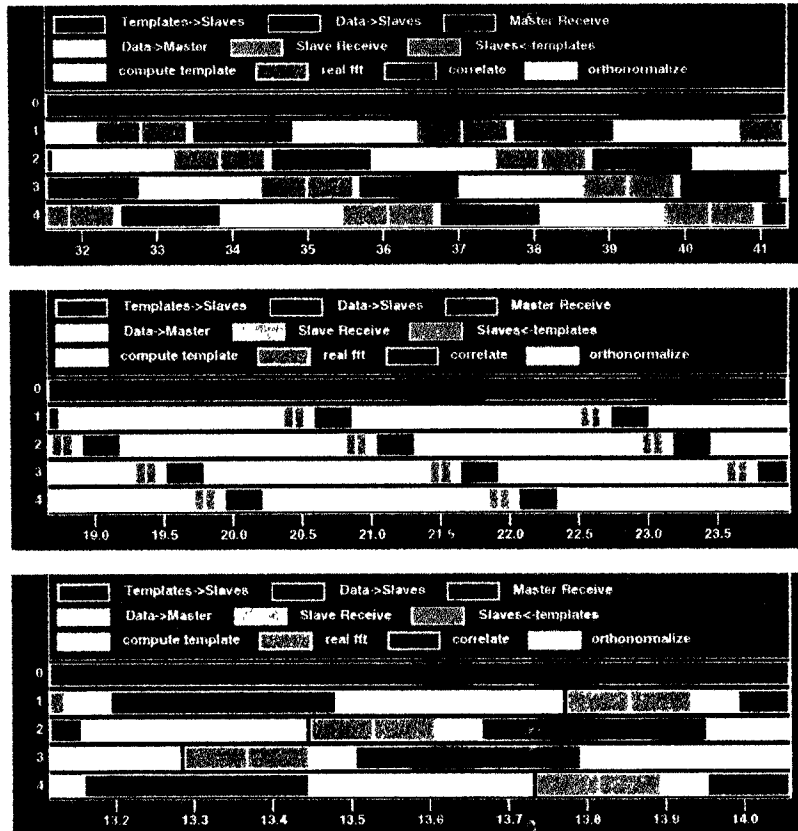

TOP: *Numerical Recipes* FFT routine `realft()`: 4.2 seconds to process 6 seconds of data.
MIDDLE: Uses *CLASSPACK* optimized FFT routine: 2.1 seconds to process 6 seconds of data.
BOTTOM: Inline functions for cube-root and sine/cosine functions: 780 msec to process 6 seconds of data.

8.14 Function: `slepian_tapers()`

`int slepian_tapers(int num_points, int nwin, double *lam, float nwdt, double *tapers, double *tapsum)`

This function computes and returns properly-normalized Slepian tapers. It uses the method described in Percival and Walden [17] pages 386-387, finding the eigenvectors and eigenvalues of a tri-diagonal matrix. The arguments are:

num_points: Input. The number of points N in the taper.

nwin: Input. The number of tapers computed.

lam: Output. Upon return, `lam[0..nwin-1]` contains the eigenvalues λ of the tapers. Note that $0 < \lambda < 1$.

nwdt: Input. The (total sample time) \times (frequency resolution bandwidth) product.

tapers: Output. Upon return: `tapers[0..num_points-1]` contains the first taper, `tapers[num_points..2*num_points-1]` contains the second taper, and so on.

tapsum: Output. On return `tapsum[0]` contains the sum of the `num_points` values of the first taper, `tapsum[1]` contains the sum of the values of the second taper, and so on. Note that because the odd-index Slepian taper functions are odd, `tapsum[1,3,5,...]` would vanish if it were not for round-off and other numerical error.

This function will print a warning message if the condition $K < 2NW\Delta t$ is not satisfied (see Section 8.13).

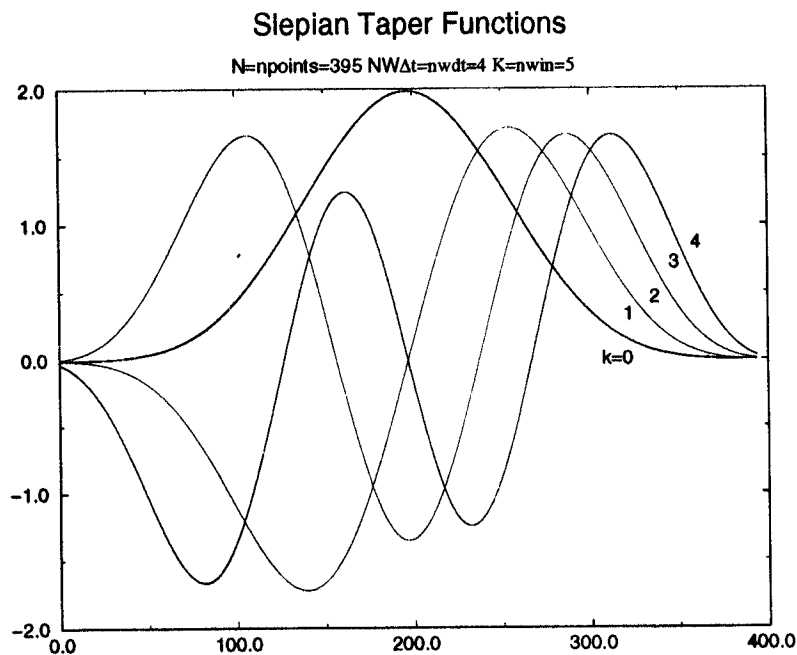

Figure 41: Here are five Slepian tapers computed with `slepian_tapers()`. The parameters are `npoints=395`, `nwdt=4.0` and `nwin=5`.

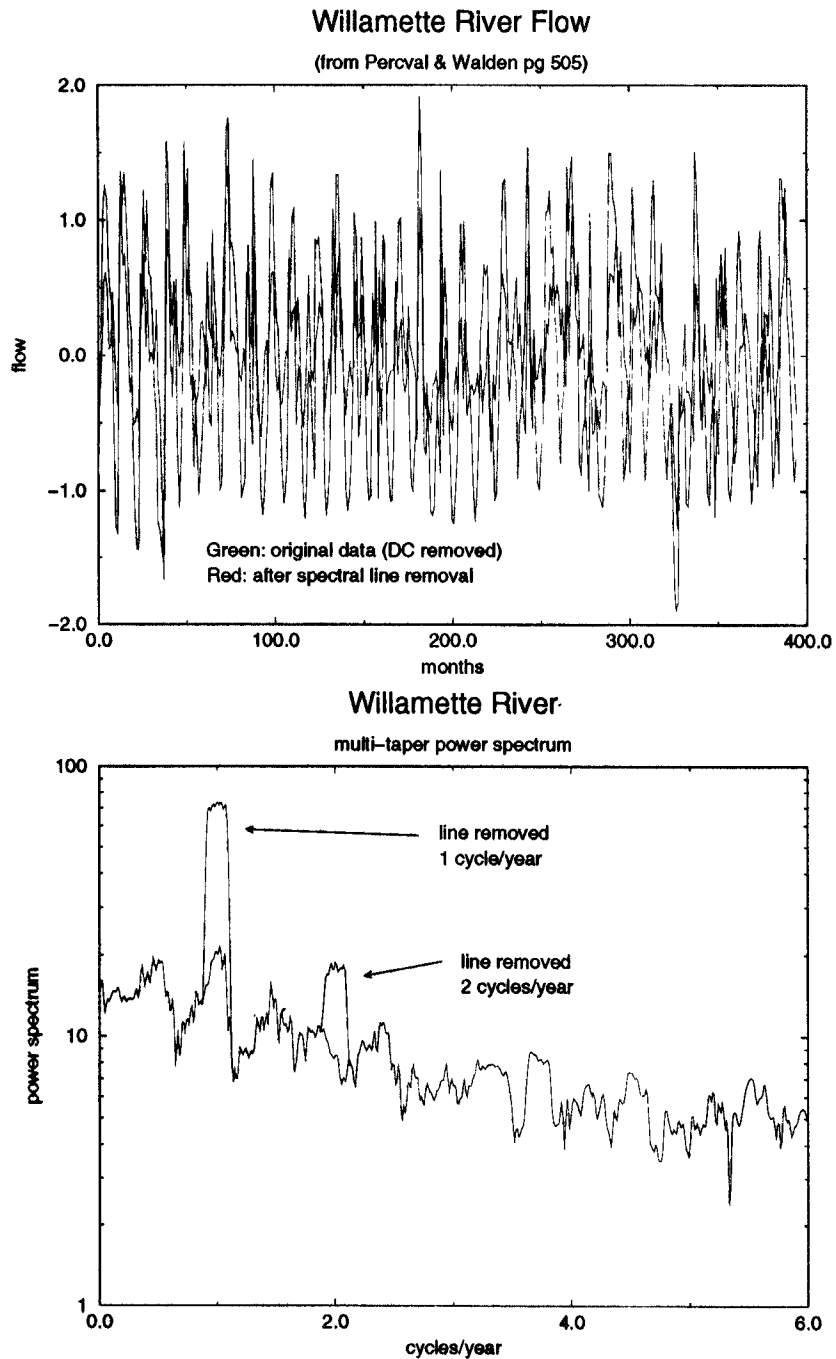

Figure 42: Output of the example program `river`, making use of `remove_spectral_lines()` to automatically find and remove two “spectral line” features from a data set. This is the same example treated by Percival and Walden in Section 10.13 of their textbook.

MULTI-TAPER METHODS FOR LINE REMOVAL

This is a list of spectral lines identified by the multitaper F-test method:

Total number of lines removed: 39

Removed line frequency 30.717 Hz amplitude 0.78 phase 15.54 (F-test 68.6)
Removed line frequency 79.203 Hz amplitude 0.55 phase -157.41 (F-test 52.5)
Removed line frequency 80.257 Hz amplitude 0.12 phase -101.84 (F-test 39.3)
Removed line frequency 109.318 Hz amplitude 4.52 phase 10.21 (F-test 75.5)
Removed line frequency 120.009 Hz amplitude 0.46 phase 5.01 (F-test 537.9)
Removed line frequency 139.584 Hz amplitude 0.29 phase -163.57 (F-test 304.5)
Removed line frequency 179.938 Hz amplitude 21.91 phase -43.22 (F-test 3635.0)
Removed line frequency 239.867 Hz amplitude 0.45 phase 130.25 (F-test 42.2)
Removed line frequency 245.438 Hz amplitude 0.21 phase -116.94 (F-test 51.9)
Removed line frequency 279.167 Hz amplitude 0.31 phase 0.52 (F-test 47.2)
Removed line frequency 299.947 Hz amplitude 15.37 phase -135.82 (F-test 9712.5)
Removed line frequency 359.876 Hz amplitude 1.17 phase 61.64 (F-test 134.8)
Removed line frequency 419.955 Hz amplitude 4.48 phase -39.58 (F-test 356.1)
Removed line frequency 488.768 Hz amplitude 0.19 phase 165.56 (F-test 50.5)
Removed line frequency 500.212 Hz amplitude 0.64 phase 129.38 (F-test 34.5)
Removed line frequency 539.964 Hz amplitude 5.09 phase 119.38 (F-test 425.2)
Removed line frequency 571.585 Hz amplitude 4.01 phase 120.03 (F-test 50.6)
Removed line frequency 578.662 Hz amplitude 34.97 phase -149.12 (F-test 429.8)
Removed line frequency 582.426 Hz amplitude 107.36 phase 15.64 (F-test 1129.7)
Removed line frequency 597.936 Hz amplitude 58.72 phase 63.27 (F-test 558.6)
Removed line frequency 605.314 Hz amplitude 17.21 phase -140.57 (F-test 489.7)
Removed line frequency 659.822 Hz amplitude 2.20 phase -152.53 (F-test 121.0)
Removed line frequency 779.831 Hz amplitude 3.95 phase -39.18 (F-test 502.4)
Removed line frequency 839.760 Hz amplitude 2.75 phase -172.15 (F-test 468.2)
Removed line frequency 899.840 Hz amplitude 3.40 phase 113.05 (F-test 529.6)
Removed line frequency 959.919 Hz amplitude 0.80 phase 178.70 (F-test 43.2)
Removed line frequency 999.822 Hz amplitude 1.01 phase 67.74 (F-test 114.8)
Removed line frequency 1019.698 Hz amplitude 1.46 phase -156.72 (F-test 146.6)
Removed line frequency 1079.777 Hz amplitude 3.00 phase 51.82 (F-test 128.9)
Removed line frequency 1157.023 Hz amplitude 2.99 phase -76.14 (F-test 129.4)
Removed line frequency 1210.778 Hz amplitude 2.12 phase 128.39 (F-test 69.5)
Removed line frequency 1319.644 Hz amplitude 3.02 phase -105.29 (F-test 146.2)
Removed line frequency 1499.582 Hz amplitude 1.31 phase 141.94 (F-test 50.5)
Removed line frequency 1559.662 Hz amplitude 2.79 phase 107.12 (F-test 60.0)
Removed line frequency 1746.978 Hz amplitude 1.81 phase 50.38 (F-test 112.0)
Removed line frequency 2039.697 Hz amplitude 1.65 phase 165.82 (F-test 62.3)
Removed line frequency 2279.413 Hz amplitude 2.12 phase -25.06 (F-test 163.0)
Removed line frequency 3509.465 Hz amplitude 0.11 phase 43.89 (F-test 60.1)
Removed line frequency 4609.720 Hz amplitude 0.03 phase 24.61 (F-test 39.4)

QUESTIONS FOR THE FUTURE

Some scientific questions to investigate:

- Verify spacing of templates (determined theoretically) with Monte-Carlo signal injection studies.
- Study improvement of SNR in binary inspiral search using line-removal algorithm to “clean up” signal.
- Can multitaper estimates of template/signal correlation reduce bias in estimate?
- Investigate quantization noise and its effects on signal detection.
- Study correlations between channels. Can this explain some spurions? Can we find why IFO loses lock?
- Understand why violin modes are not well-modeled by $e^{-t/\tau} \sin(\omega t)$.
- Try Pinto’s Wigner-Vielle wavelet technique.
- Can we develop signal analysis techniques to automatically identify bumps, scrapers, howlers, etc?

Plans for 40 Meter Data Analysis

On-line Analysis: (Multi-Taper Methods)

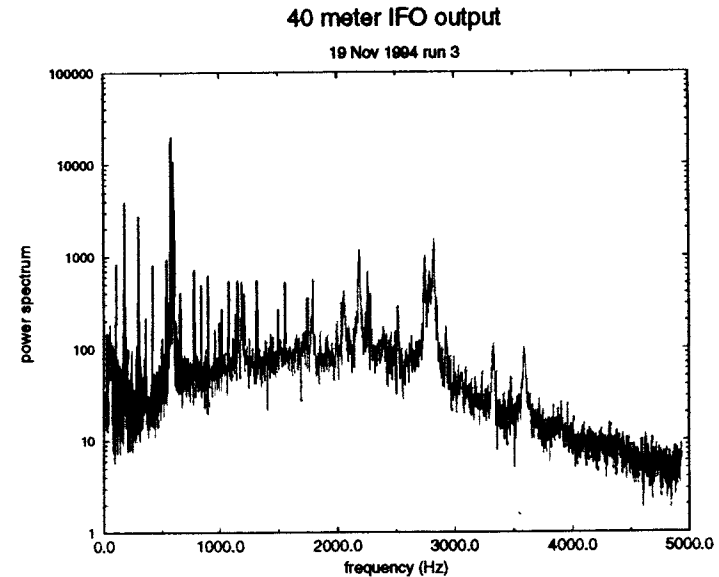
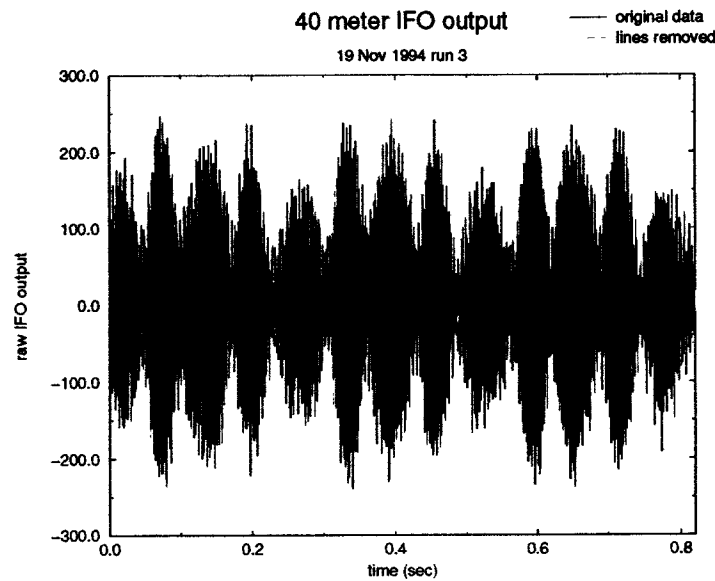

- **Uses multiple sets of special windows called Slepians**
- **39 narrow lines identified and removed in the red plots**
- **Provides better spectral estimation**
- **Provides spectral line parameter estimation and removal**
- **30% improvement in signal to noise ratio after lines removed**

Plans for 40 Meter Data Analysis

On-line Analysis: (Multi-Taper Methods, cont.)

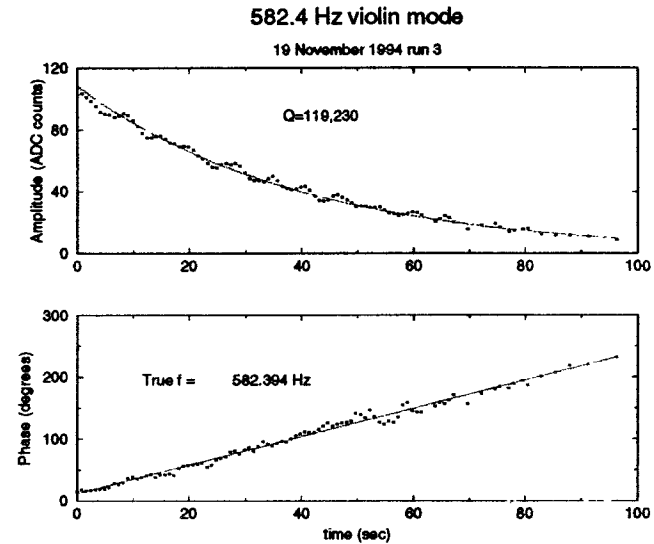
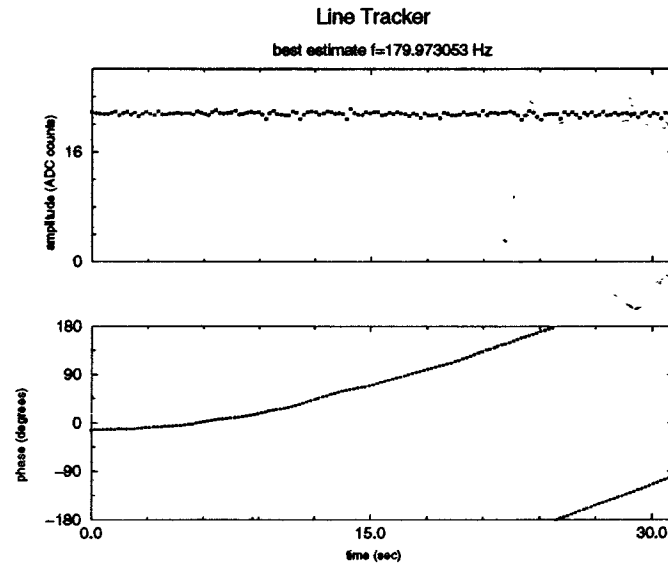

- Useful as a diagnostic tool
- Allows track of narrow lines
- Using UltraSparcs1 workstation, line can easily be tracked in real time

40m Data Acquisition System Overview and Demo

B. Ware, F. Raab, R. Bork



40m DAQS Prototype

- Goals

- ›› Verify conceptual design
- ›› Provide test system for hardware/software
- ›› Provide base for integrating analysis software
- ›› Provide users with an example to further define requirements

- Features included in initial release

- ›› 32, 16 bit ADC channels with sampling rates of 16384 K samples/sec
- ›› Integration of previously developed Slow Data Acq. system
- ›› Digital networks to move data to a central framebuilder
- ›› Framebuilding, using VIRGO defined frames and software library
- ›› Data storage to disk and tape

Prototype System Hardware

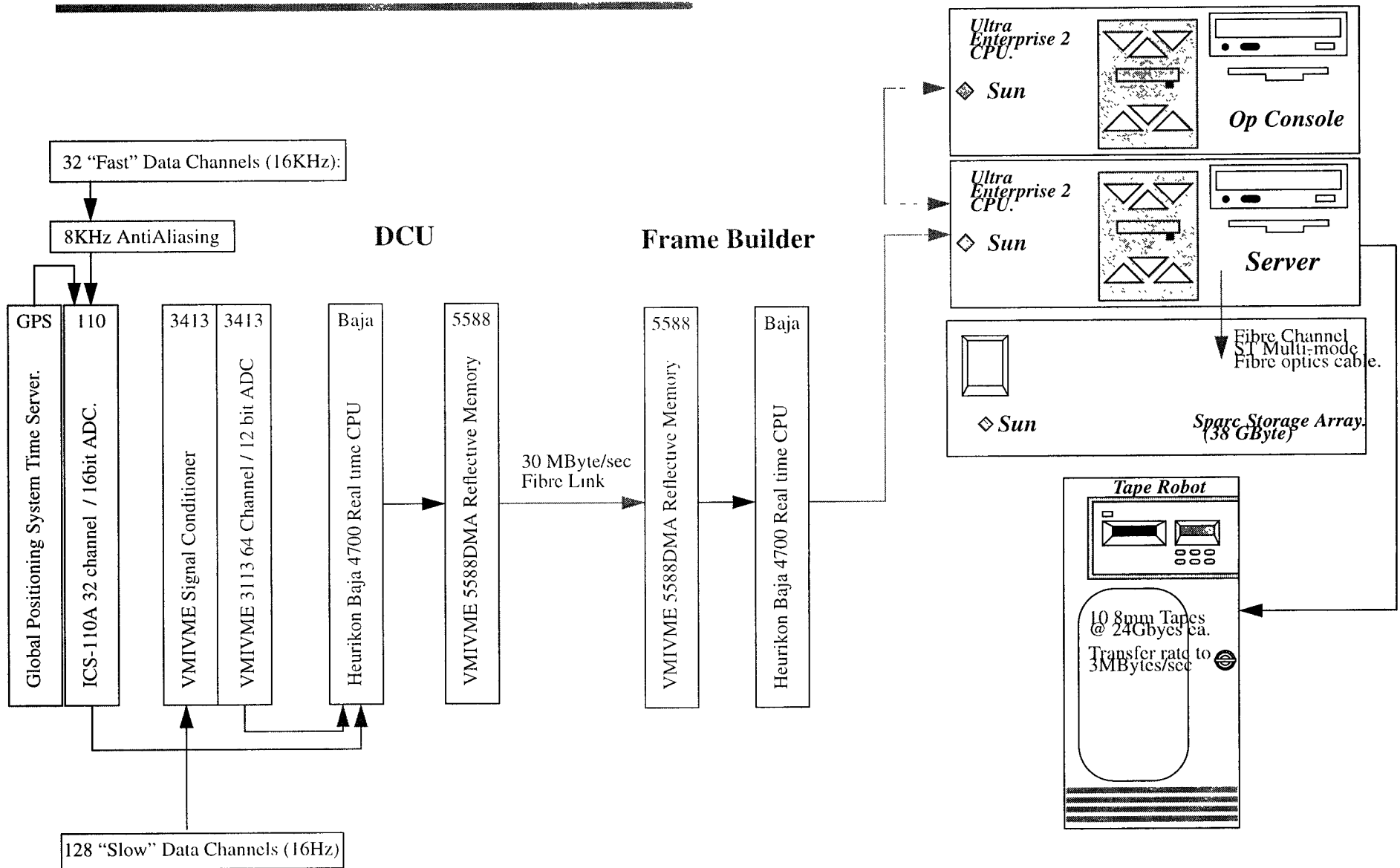

DCU/FrameBuilder Data Flow

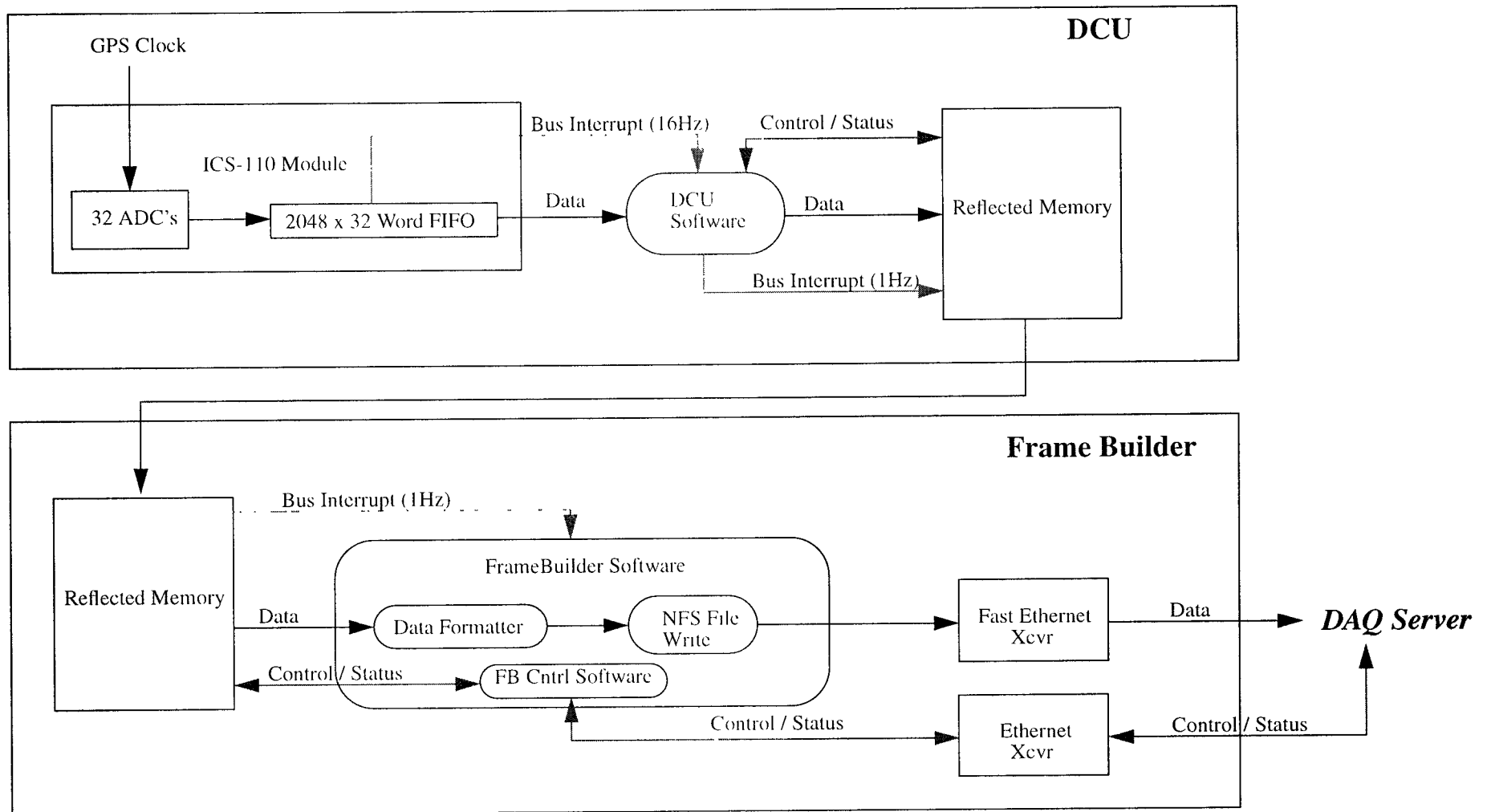

DAQS Control Software

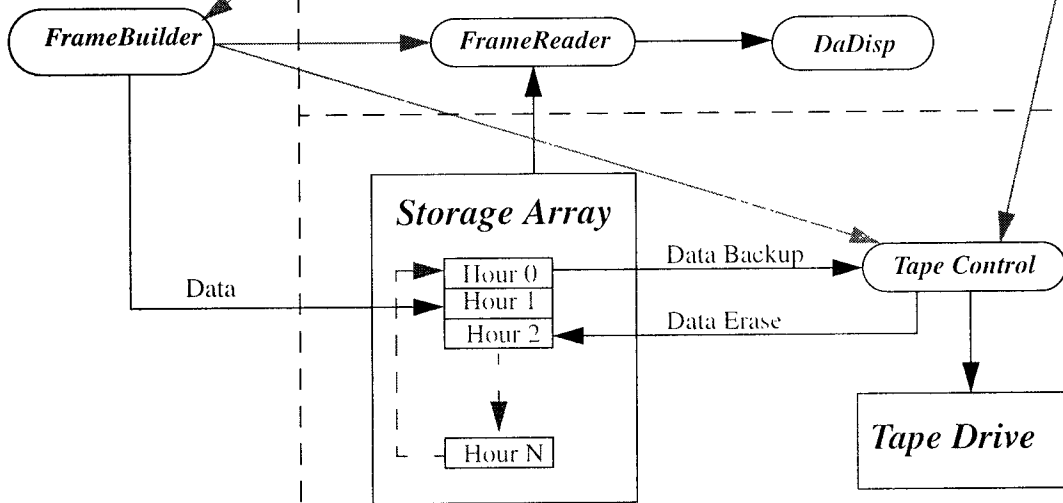

Op Console

Server



DAQS Prototype Status

- System installed at 40m and initial testing begun.
- Measured throughput of ~1MByte/sec, limited by:
 - ›› NFS write over Fast Ethernet (To be replaced by FC and client/server software and larger file sizes)
 - ›› CYbernetics Accelerated File Access (CYAFA) write to tape
- Initial Frame libraries are functional, both read and write, with “real-time” connections to xmgr and GRASP tested.

Introduction to Advanced R&D

Discussion Issues

G. Sanders



Introduction to Advanced R&D Discussion Issues

Gary Sanders

May 23, 1997

LIGO Science/Integration Meeting



Agenda

Introduction ...	Sanders (5 min)
Signal recycling / table top	Reitze (15 min)
RSE / table top	Mason (15 min)
Discussion	(15 min)
Seismic/Suspension/Thermal Noise Working Group Plans and MIT group plans	Shoemaker (20 min)
Discussion	(15 min)
MIT Group Transition and Research Facility Upgrade	Zucker (20 min)
Discussion	(15 min)
Caltech - 40 Meter Options	5 speakers (40 min)
Discussion	(20 min)



Issues

- 1997 Funding ~\$900K is here. We need to tune our program allocations
 - » Sapphire
 - » Thermal Noise Interferometer
 - » Optics for Higher Power
 - » 40 Meter program evolution
 - » RSE
 - » MIT program evolution
- MIT Interferometer role in the outyears
- 40 Meter Interferometer role in the outyears
- Revised outyear Advanced R&D proposal due Fall '97



MIT Interferometer/Role

- Vacuum system capable of housing full scale LIGO isolation systems
- Last testbed before fabrication for LIGO upgrades
- Does this limit MIT role in other research?
- How does this fit in a US program with the Caltech, MIT and Stanford testbeds?
 - » There appears to be community consensus on need for all 3 systems
 - » How is access, relative program planning, availability assured?



40 Meter Interferometer

- Recycling
- Data acquisition experiments
- Modeling experiments
- Upgrades to suspensions, controllers, all infrastructure
- Diagnostics research
- Infrared conversion
- Gravitational wave searches leading to publications
- RSE/SR experiment
- Adaptive controls research
- ...



Review

- Proposals to be authored by real champions who will lead and carry out the research
- If collaborative, proposal requires support of Collaboration and/or Development Group and appropriate collaborative MOU's
- Internal proposals for all supported research without exception
 - » Website draft to be revised
- Internal staff reviews
- PAC review
- LIGO Lab Directorate decision



Signal Recycling R&D at University of Florida

D. Reitze



LIGO Advanced R&D: Table-Top Dual Recycled Interferometer

Dave Reitze

UF



Advanced R&D: Dual Recycling

Initial LIGO: power recycled Michelson IFO

$$h_{\min} \sim 10^{-21} \quad \text{-->> low event rate}$$

Advanced LIGO: increased strain sensitivity and event rate by alternative interferometer topologies

Constraint on advanced detector: easily upgraded from current LIGO

- Dual (Power + Signal) Recycling (Meers, 1988)- increase storage time of GW by resonant cavity
- Table-top DR Michelson configuration demonstrated by Strain and Meers (PRL, 1991)

Dual-Recycled Interferometers

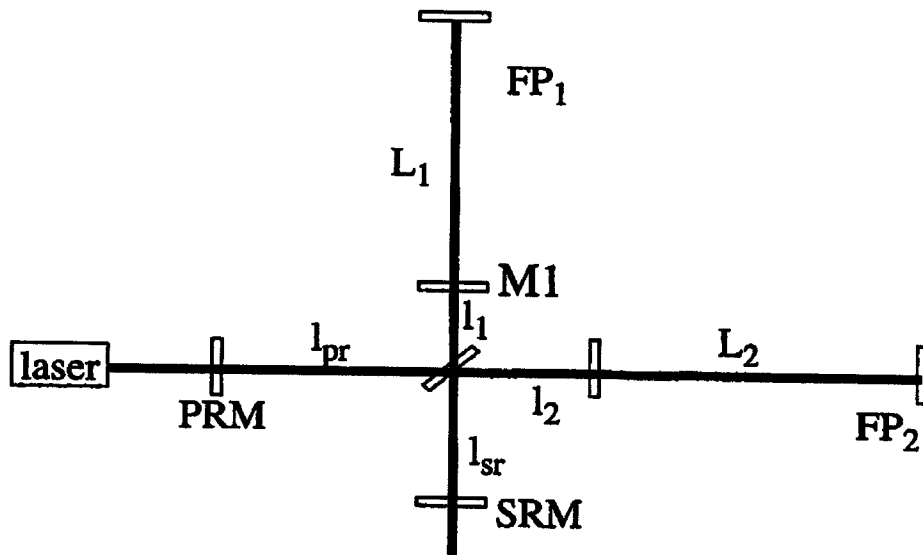

- $l_1 + l_{sr}$ chosen to make M1 - SRM cavity anti-resonant; increase storage times, decreased Δf
- tuning achieved by changing position of SRM

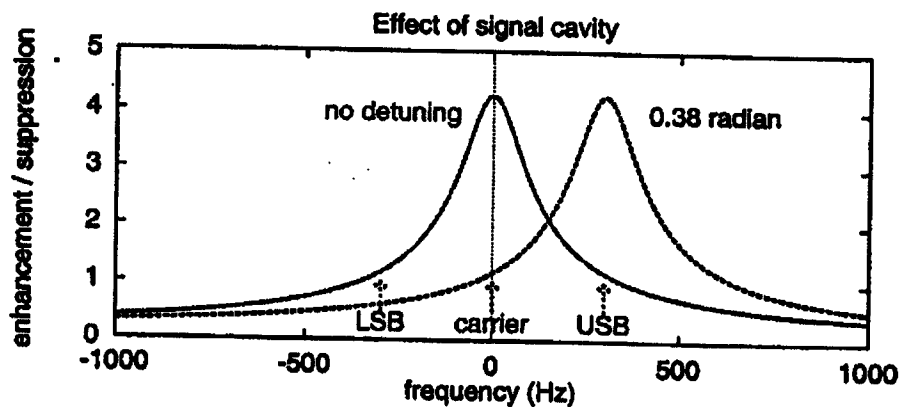

Control Systems Considerations for DR Interferometers

- Schnupp asymmetry ($l_1 \neq l_2$)
- locking of signal recycling mirror

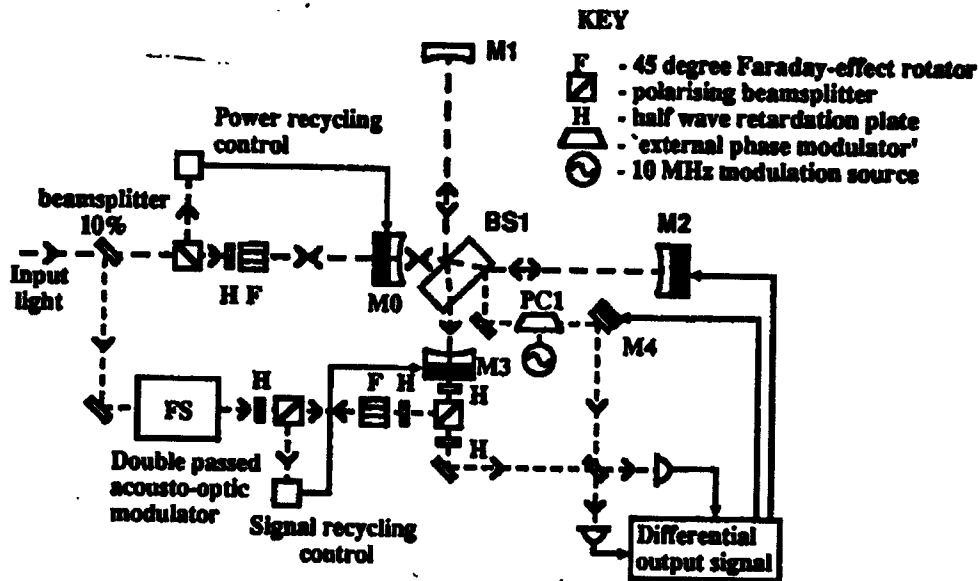

FIG. 6. The optical layout of the dual recycling experiment.

- signal pickoff placement
- ???

Goals of the Table-Top Investigations

- Investigate DR interferometer length control and establish lock acquisition protocols:
 - ››length sensing and control of FP arms, power recycling mirror, signal recycling mirror, and the signal recycled cavity
 - ››Formulation of control topologies and lock acquisition sequences
 - ››design and testing stable servo-loops
- Narrowband “GW” tuning
 - ››coupled to control loops / servo design
- Modeling (frequency or time domain)
- Training ground / evaluation for implementation on suspended interferometer.

Workplan/Status

- **Workplan (2 year time-frame)**
 - ›› model frequency response / control system concept
 - ›› PZT mounts fabricated / optical layout
 - ›› servo loop design and fabrication
 - ›› lock protocol
 - ›› analysis of locked interferometer
 - ›› tuning studies
- **Personnel**
 - ›› Postdoc: Search Underway
 - ›› Graduate Student: Tom Delker
- **Infrastructure**
 - ›› 800 ft² dedicated lab space in UF LIGO Laboratory
 - ›› Equipment funds requested from NSF

MIT Group Transition and Research

M. Zucker



LIGO@MIT:

Transition to Operations and Advanced Detector R&D

M. Zucker

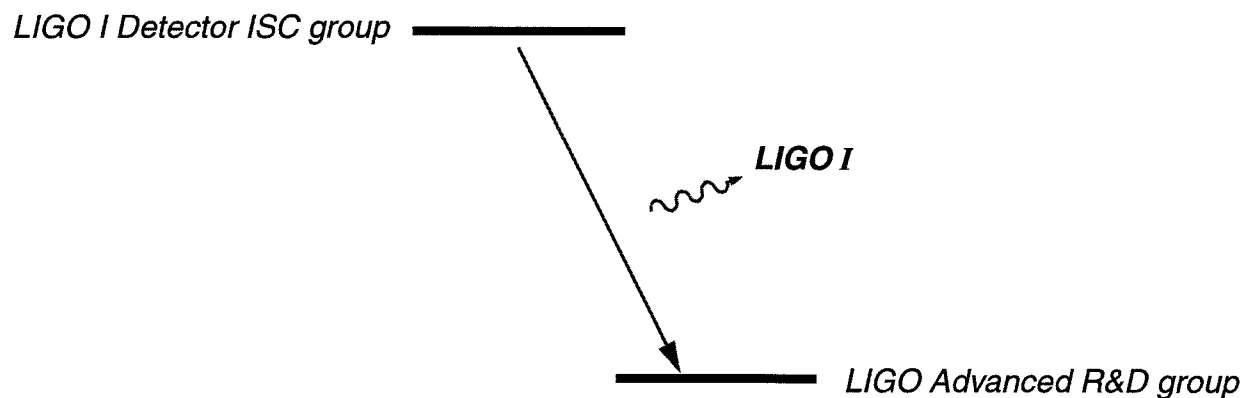

NOW: Construction



Next: Integration & Commissioning

- Priority: *get LIGO I into operation*
- Focus is site-based
 - Installation, commissioning, diagnostics centered at Hanford & Livingston
 - “Pre-lockup” phase: all hands on one task (lead, follow or get out of the way)
 - “Post-lockup” phase: break out parallel investigations & concurrent tasks
- Campus facilities deployed mainly in support roles
 - Field equipment prep, cal, test (even repairs...)
 - Diagnostic modeling/simulation
 - “Integration Support R&D” ; rapid response to new findings
 - > First machine of its kind; expect issues needing experimental answers
 - > e.g., optical scattering, outgassing, PEM correlations, detector nonlinearity, surface analysis, vibration/acoustic modes, RFI tests, ... ?

Remote Site/Campus Staffing Model

- Challenge:
 - involve students, postdocs, faculty in work which is fundamentally site-based
 - maintain ties & communication between site & campus resident personnel
 - help sites draw on campus resources, experience
- Response: staff rotations
 - cut deals for extended leaves (~2 weeks to ~academic term or longer)
 - terms interleaved so team members overlap, continuity preserved
 - projects given both site- and campus-based (or portable) components
- 2 postdocs, 1 student signed up with Weiss so far (PEM, quicklook data analysis, diagnostics)
- Others looking at installation schedule for best phasing

End State: Operations & Advanced R&D (as we'd like to see it)

- Data analysis...physics...discovery!
- LIGO Operations Support
 - Site staff rotations continue to support facility operations
 - Campus analytical, simulation, experimental detector support continues
 - Update/revisions/service for LIGO I systems & instrumentation
- Advanced Subsystem and Detector Development
 - Double Pendulum Suspension
 - Active Seismic Isolation
 - High-power Lasers & Optics
 - Advanced Detector Configurations

Detector Upgrades: Advanced Subsystem & Configuration Staging

- Trial/debug of new technology in LIGO directly impacts observation time ('either upgrade, or do science')
- Need primary testing coverage *offline*; hierarchical development/engineering path
 - Modeling, analysis, simulation
 - Tabletop proof of concept/technology demonstration
 - "Large"-scale test on suspended, evacuated interferometer testbeds
- Multiple suspended, evacuated testbeds required for scaling confidence & total throughput capacity
- Problem: "laboratory scale" final test isn't so final!
 - Too many parameters are tied up intricately with mechanical dimensions

Problems with “scaled-down” test extrapolation:

- Fit, interference, & assembly not fully addressed (though mockups help)
- Design extrapolation subject to errors (pole frequencies, reaction inertias, mechanical impedances)
- Parasitic structural resonances may go undetected
- Dynamic reserve allocation significantly modified
- Control system solves “different problems” than real application needs (worse as active isolation is included)
- All above add risk of **OBSERVING DOWNTIME** when full-scale version is integrated at sites!

Example: alignment control & stacks

Equivalent SISO model

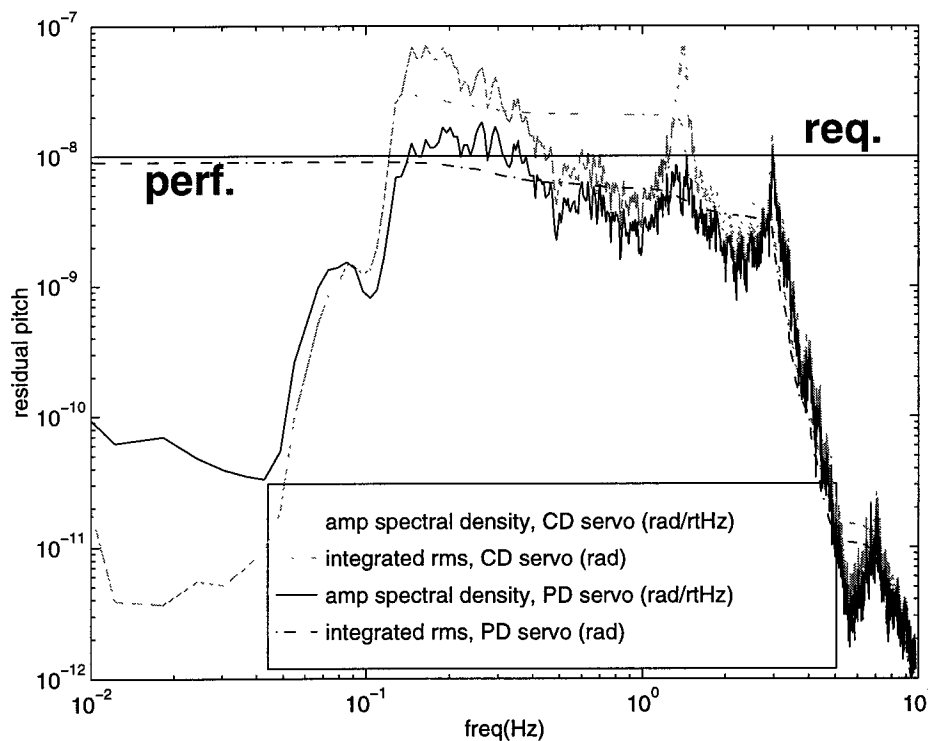
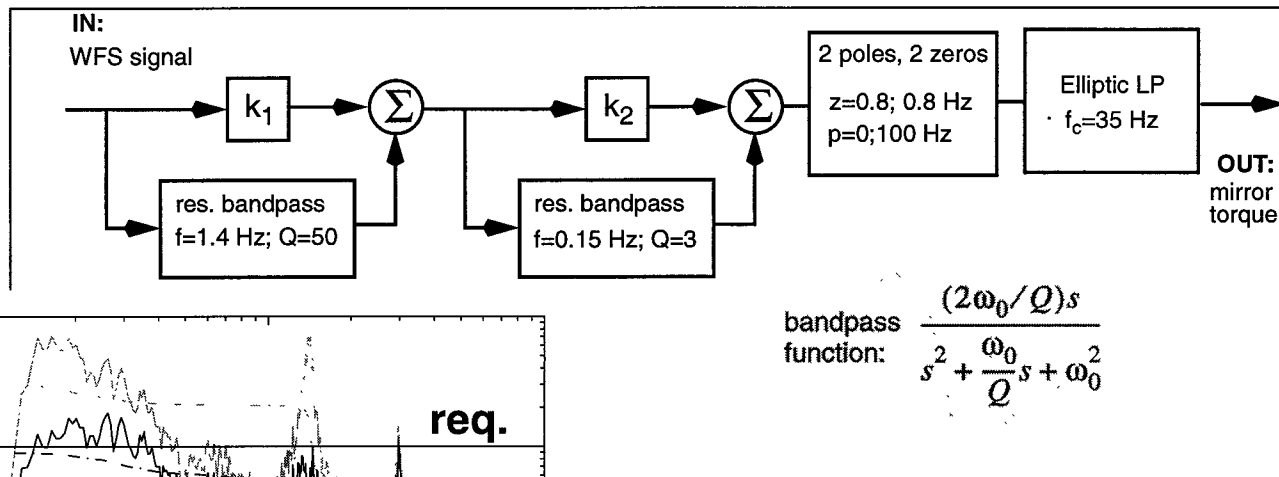

Performance vs. RMS residual requirement (end test mass pitch, Livingston seismic noise, Hytec Leaf Spring stack model)

Opportunity Knocks: Building 20 Condemned! (film at 11)

- MIT LIGO group will move to NW 17 (across Mass. Ave.) early '98
- MIT will furnish a 4,000+ sq. ft. high bay
- Compatible with BSC and HAM, stacks, cleanrooms, etc.
- Cranes & power/cooling utilities to suit
- Additional steps (TBD) to reduce Cambridge seismic vibration background
 - New site is ~ as noisy as Building 20
 - Looking at civil, active options (Accentech/BBN)

NW17 Location on MIT Campus

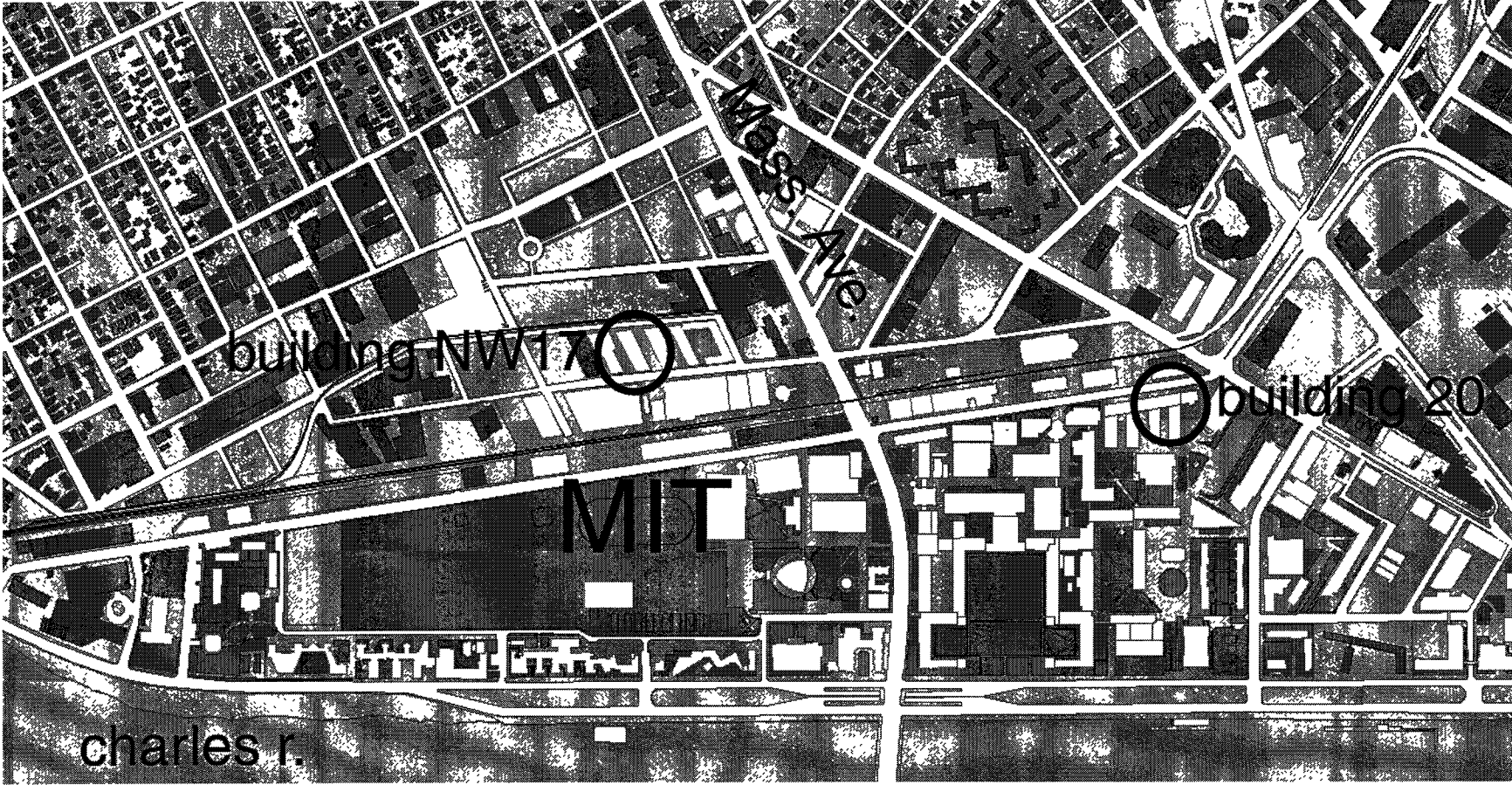

Goal: “Plug-Compatible” Suspended Interferometer Testbed

- Exact duplicate of LIGO vacuum envelope, isolation, support components
- Provides user facility for LIGO collaboration
 - Final qualification step for upgrades (irrespective of origin)
 - Adds another suspended-interferometer testbed
 - > explore multiple advanced IFO options at once
 - > ‘divide, *scale appropriately* and conquer’ (e.g., phase noise + displacement noise)
 - Typical experiment to involve Laboratory, Collaboration contributors
- Build in two phases:
 - Phase I: one HAM, one BSC, 16.4 m baseline (double suspension tests)
 - Phase II: add two more HAMs for complete Michelson topology

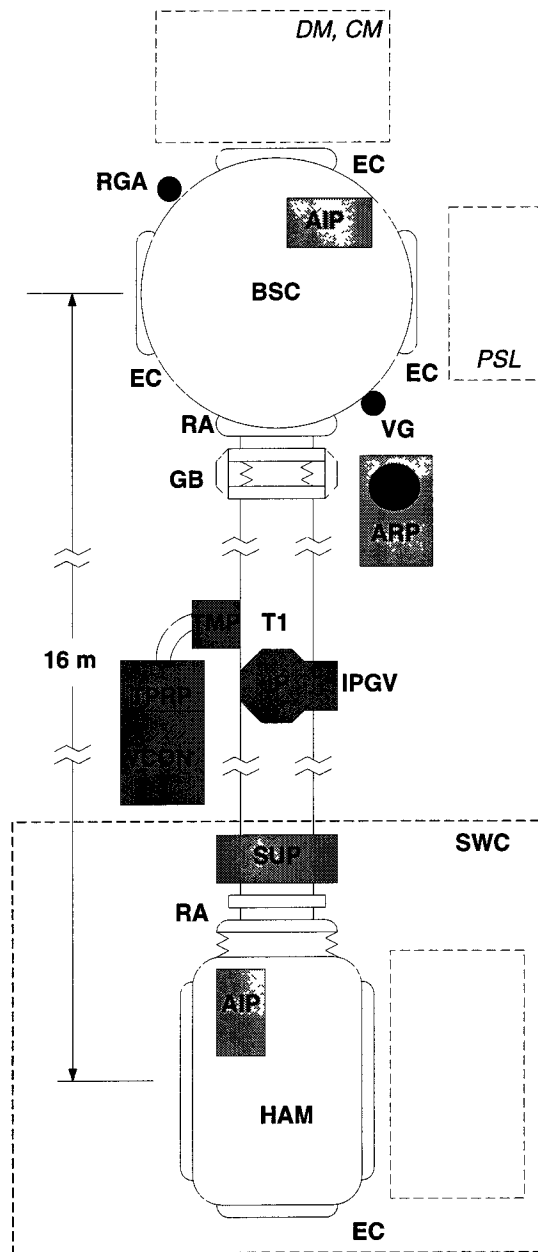

MIT R&D Vacuum Envelope Concept: Phase I
 mez 5/15/97

HAM	Horizontal Access Module
BSC	Basic Symmetric Chamber
EC	End cap (ported)
RA	Reducer A (60 X 48)
RB	Reducer B (84 X 48)
SUP	Tube support/thrust anchor
IP	Ion pump
IPGV	Ion pump isolation gate valve
T1-3	48" ID tube sections (ported)
TMP	Turbomolecular pump (valved)
TPRP	Turbo backing/roughing pump
VCON	Vacuum system control/monitor rack
AIP	Annulus ion pump
ARP	Annulus roughing pump (portable)
GB	Demountable gimbaled bellows, 48" ID
VG	Vacuum gauge set (valved)
RGA	Residual gas analyzer head (valved)
SWC	Softwall cleanroom (typ.)

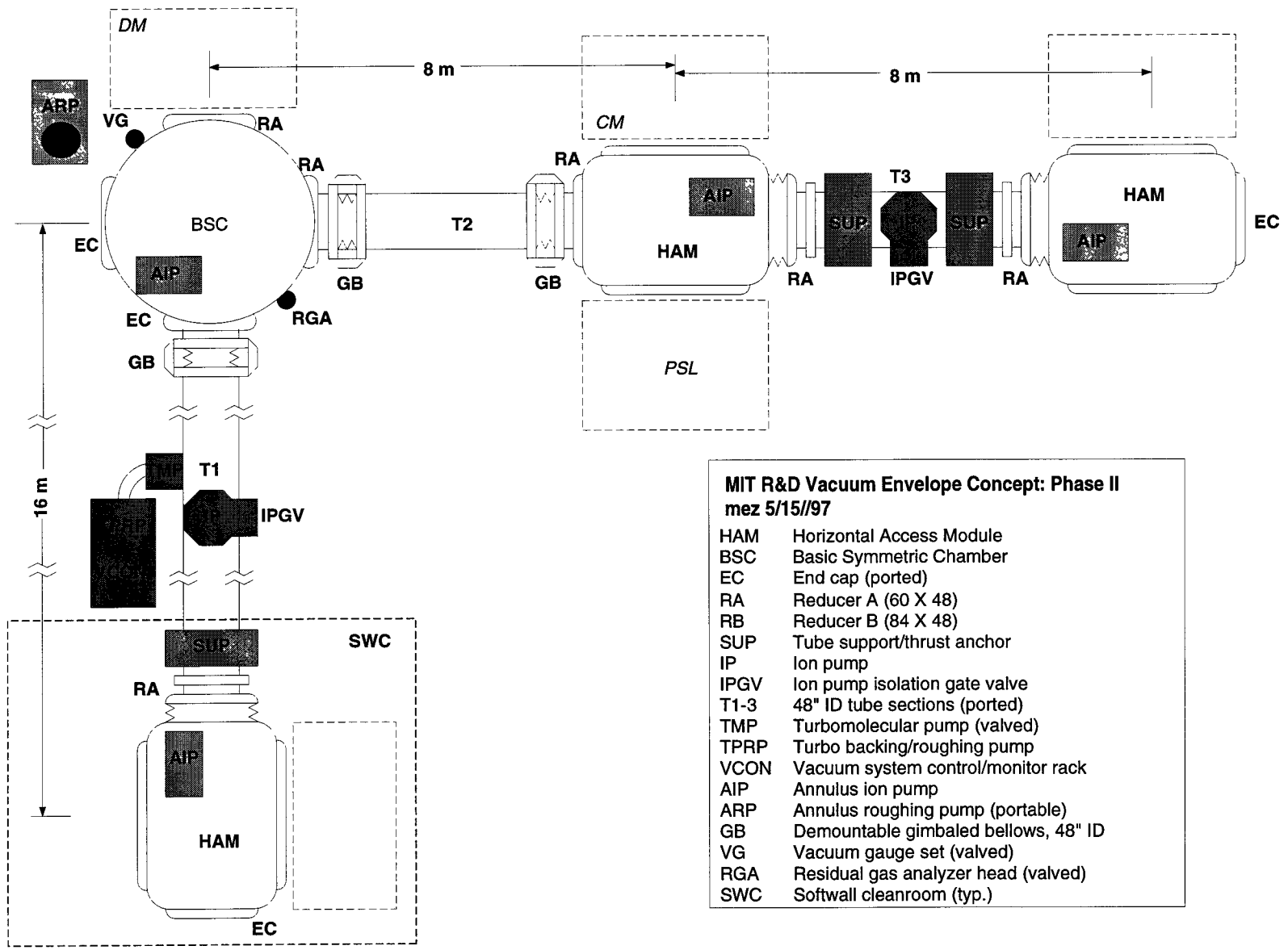

MIT R&D Vacuum Envelope Concept: Phase II
 mez 5/15/97

HAM	Horizontal Access Module
BSC	Basic Symmetric Chamber
EC	End cap (ported)
RA	Reducer A (60 X 48)
RB	Reducer B (84 X 48)
SUP	Tube support/thrust anchor
IP	Ion pump
IPGV	Ion pump isolation gate valve
T1-3	48" ID tube sections (ported)
TMP	Turbomolecular pump (valved)
TPRP	Turbo backing/roughing pump
VCON	Vacuum system control/monitor rack
AIP	Annulus ion pump
ARP	Annulus roughing pump (portable)
GB	Demountable gimbaled bellows, 48" ID
VG	Vacuum gauge set (valved)
RGA	Residual gas analyzer head (valved)
SWC	Softwall cleanroom (typ.)



Symmes Maini & McKee Associates

1000 Massachusetts Avenue
Cambridge, Massachusetts 02138
617.547.5400 Fax 617.354.5758

EXISTING
OVERHEAD
DOOR

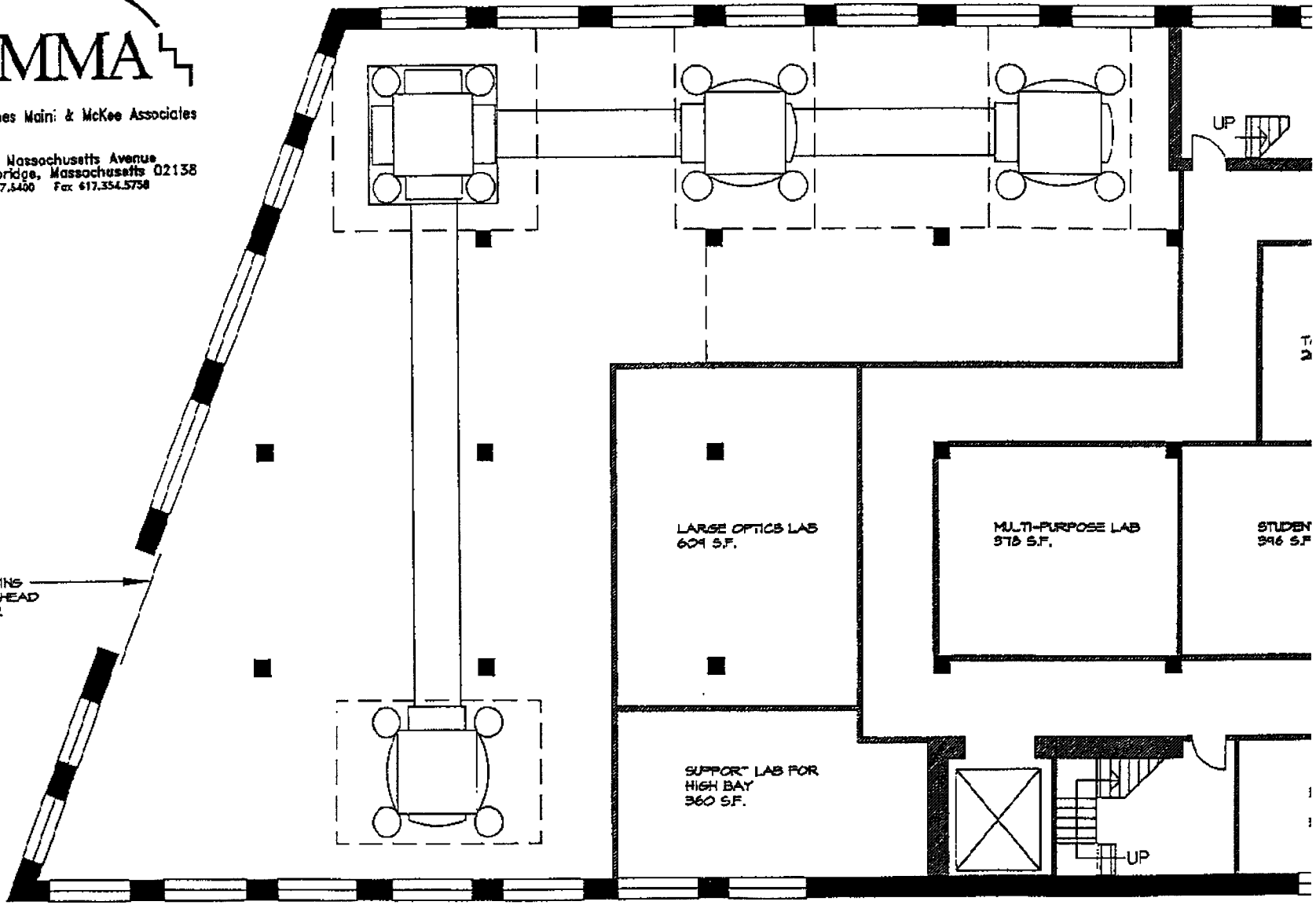

Running the MIT Facility

- Priorities of Laboratory (peer-reviewed proposals) to be implemented by local manager & staff with collaborators
- Based on 40m & 5m models, expect 4-6 person team on typical experiment (more during construction/reconfig.)
- Continuity with tabletop precursor & support expt's, modeling/simulation 'vertical integration'
- 1-1.5 FTE associated with running facility, not attributable to experiment in progress (mgmt, engineering, project tech)
- need to achieve short learning curve for new trainees
 - good documentation, effective procedures, clear legacy
 - vigilant maintenance & upgrade program ('good enough' not good enough!)

Timeline

- 11/97 - NW17 renovation begins.
- 1/98 - Lab move starts (offices, tabletop labs, computing net available immediately). PNI experiment completed.
- 3/98 - Lab move complete. Double suspension precursor experiments begin in tabletop lab. High bay available.
- 9/98 - MIT Phase I vacuum envelope shakedown.
- 1/99 - Double suspension tests start in new vacuum system
- 3/01 - Phase II vacuum envelope expansion complete, full-interferometer testing of enhanced subsystems begins
- 9/03 - Enhanced subsystem(s) qualified and ready for production and site installation

40m Interferometer Plans

M. Coles



40 Meter Interferometer Plans

- Establish a set of program goals for the next year
- Develop a schedule to reach these goals
- Define resources required
- Be sensitive to planning requirements beyond the next 12 months
- Run 40 m as an Observatory Facility

Goals for Next 12 Months

- Inside the vacuum:
 - Complete hardware reconfiguration for power recycling of the interferometer
 - recycling mirror installation
 - modulation frequency change
- Hardware installation complete by approximately end of June.

Goals...Outside the vacuum:

- **Install wave front sensing with limited degrees of freedom.**
- **Develop data acquisition software tools**
 - diagnostic software
 - noise source characterization/evaluation
- **Software modeling:**
 - comparison of theory and experiment for lock acquisition and maintenance
- **See if we can obtain a meaningful scientific result:**
 - For example: improved upper limit on periodic binary in-spiral

Run the interferometer

- get experience running the apparatus
- learn how to make the running robust
 - acquire lock
 - maintain lock
- manage the data (acquisition, analysis) to increase understanding of interferometer performance
- develop realtime monitoring techniques as diagnostic tools to improve operation

Run the inteferometer...ctd

- Accommodate additional goals as they arise that are compatible with continued operation,
 - examples:
 - incremental changes in control electronics to VME
 - additional wave front sensing
- No massive reconfigurations

Defer the following goals > 7/98

- IR conversion
- 12 meter mode cleaner
- VME control of all suspended masses
- Resonant side band extraction.

Supplementary Operational Goals

- Configuration control of hardware and software
- Documentation (and control of documentation)
- Dedicated staff
- Dedicated budget

Schedule

- Power recycling hardware installation 7/97
- IFO lock ?
- Limited wave front sensing installed 6/97
- Wave front sensing operational 7/97
- First release of operational software ?
- IFO under hardware configuration control ?
- Begin data taking fall 97
- First release of operational procedures ?????
- Experiments on model vs experiment ??
- First physics result ???

Resonant Sideband Extraction

J. Mason, S. Kawamura, R. Vogt



A Proposal for a table-top prototype of a Resonant Sideband Extraction (RSE) Interferometer

Science and Integration, May 1997

James Mason

Seiji Kawamura

Robbie Vogt

- **Advanced R&D on two levels**
 - ›› Advanced subsystems
 - ›› Advanced detectors
- **Initial detectors**
 - ›› Good design which is both simple and provides astrophysically interesting sensitivities.
 - ›› Can we do better?

Advanced detector - Resonant Sideband Extraction (RSE)

- Considered to be a promising optical configuration
 - ›› As good if not better shot noise limited sensitivity than standard power recycling
 - ›› Narrow band operation, in situ tunability

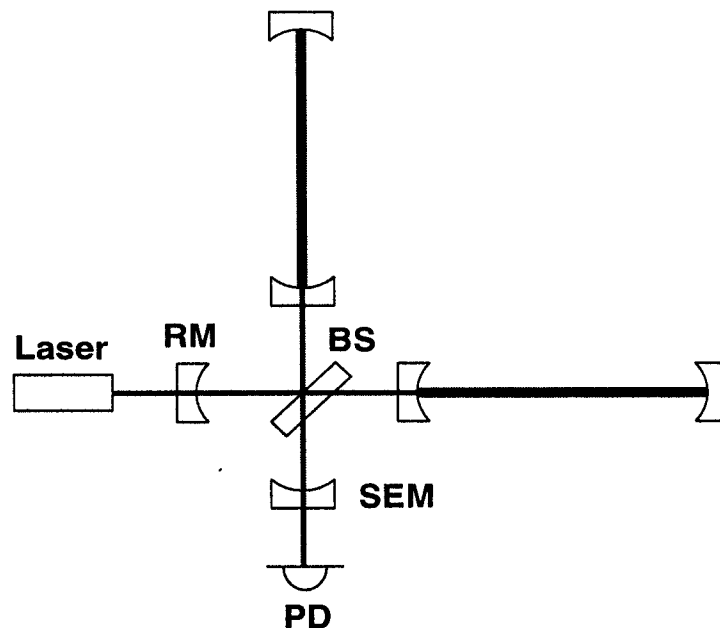

- ›› Principle has been demonstrated
 - Not using Schnupp asymmetry modulation
 - No power recycling

HEIJEL, MIZUNO, SCHLUNGS, WICKLER, ZÜDLER, DRUZHANN.

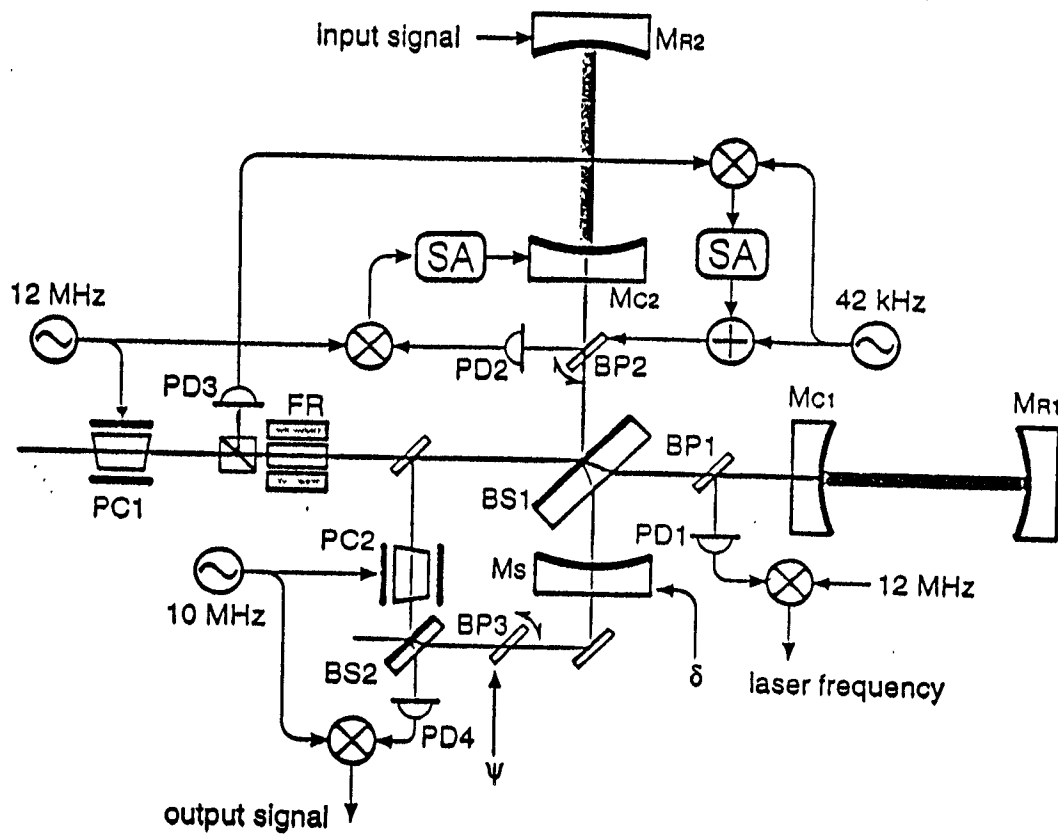

Fig. 4. Simplified diagram of our experimental setup, showing only the control loops for the arm cavities and the Michelson interferometer. FR is a Faraday rotator, PC are Pockels cells, \ominus , \oplus and \otimes electronic oscillators, adders and mixers respectively, BS beam splitters, BP glass plates in or near Brewster's angle, PD photodiodes and SA servo amplifiers. See also Figure 5.

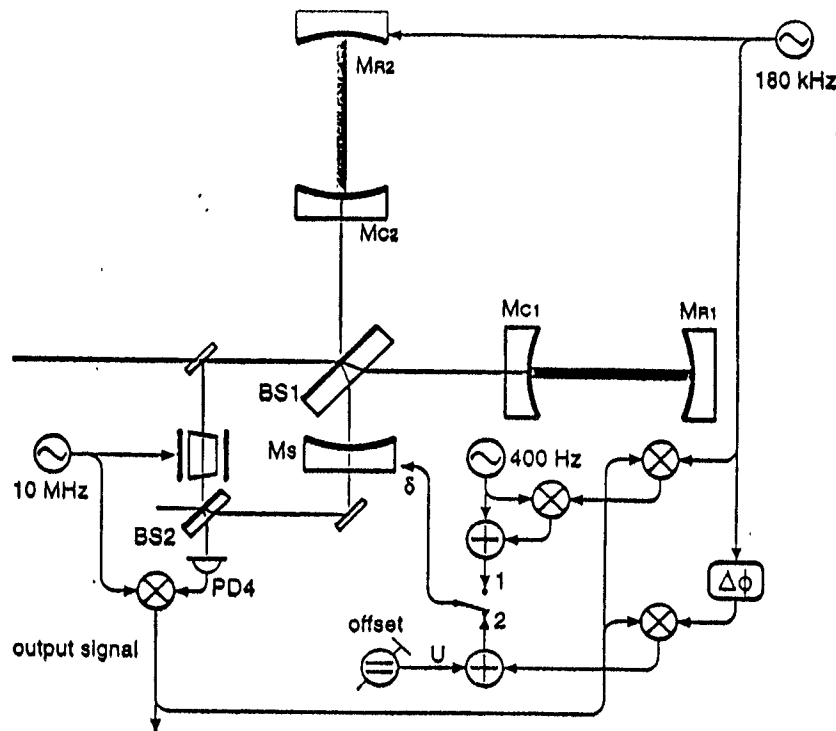
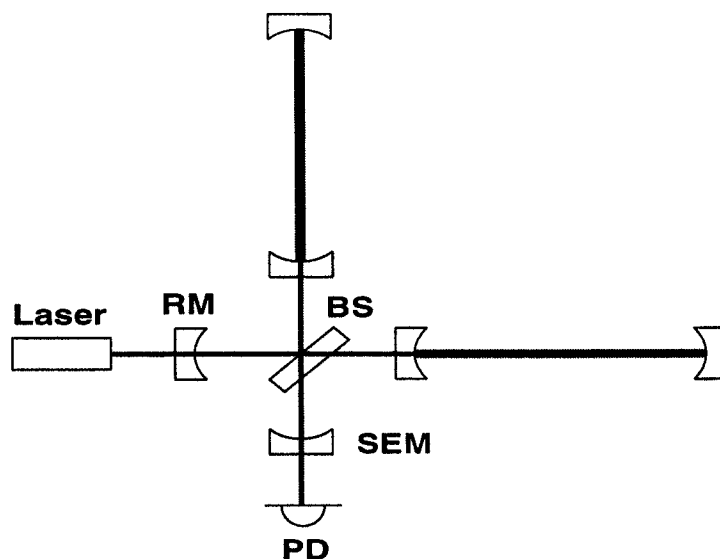

Fig. 5. Control loops for the signal extraction mirror M_s . In addition to the symbols used in Figure 4, $\Delta\phi$ represents an electronic phase shifter and \ominus an adjustable DC voltage.

Principle of Resonant Sideband Extraction



- Without the signal extraction cavity, the detector bandwidth is set by the arms
- The s.e.m. creates a coupled cavity system
 - ›› The bandwidth of the coupled cavity is a function of the s.e.m. reflectivity and the round trip phase of the extraction cavity
 - Varying the round trip phase from 0 to π varies the coupled cavity bandwidth and the frequency at which it's resonant
 - RSE uses the s.e.m. to decrease the bandwidth of the arm cavities for the signal, which allows the use of high finesse arm cavities.

Objectives of the RSE table-top project

- A signal extraction scheme utilizing Schnupp modulation to control the positions of the mirrors
- Analytical and numerical models with which to design the control systems
- Analysis and optimization of the detuning of the signal extraction mirror for narrow-band operation
- Analysis of lock acquisition, locking sequences, sign flips and gain changes compared to a time-domain model
- A Ph.D. thesis

Work Plan

- Optical parameters and configuration
 - ›› Mathematics and modeling (Mar.-Nov. '97)
 - ›› Control system configuration (May-July '97)
- Detailed interferometer design
 - ›› Purchasing and lab setup (April-Aug. '97)
 - ›› Mirror mount fabrication (June-Aug. '97)
 - ›› Control system design and fabrication (July-Dec. '97)
- Interferometer assembly and shakedown
 - ›› Locking the degrees of freedom (Oct '97-June '98)
- Analysis and characterization (Apr.-Dec. '98)
 - ›› Transfer functions and cross-couplings
 - ›› Lock acquisition studies
 - ›› Narrow-band operation
- Documentation (Jan.-June '99)

Suspension / Isolation

Advanced R&D

D. Shoemaker



Suspensions/Isolation

Science/Integration 23 May 97 dhs

LIGO Adv R&D proposal carries outline of research

- Overall plans and schedules
- LIGO activities in domain
 - > double pendulum suspension
 - > active isolation
 - > thermal noise
 - > advanced isolation

January '97 Aspen workshop: Formation of Ad-Hoc Working Group

- meeting of interested parties
- discussions of present/nearterm activities
 - > LIGO: LIGO I; requirements; plans for thermal noise measurements
 - > GEO double pendulum design: final design this spring
 - > JILA: ambitious active seismic isolation system: 6 dof, 2 stages
 - > Stanford: fiber development, bonding techniques, control system studies
 - > Syracuse (and Moscow): substrate material losses
 - > Penn. State: sensor, actuator and servo studies
 - > Caltech/Drever: magnetic suspensions

Working Group

Common activities focussed around LIGO evolution

- 2003 LIGO II advanced subsystems
 - > double pendulum explicit path
 - > moderate improvements in Q
 - > associated control changes (e.g., external active system)
- 2007 LIGO III advanced LIGO
 - > large masses, high Qs, low F seismic isolation
 - > too early for conceptual designs
 - > 'what is crossover frequency with gravity gradient limit?'
- interest in coupling activities more tightly
 - > linked schedules, joint activities

Working group

Spring APS meeting: second meeting

- ~25 persons, some there just for Suspensions etc.
- technical discussions rather than organizational issues
- presentations: gravity gradient noise, ground noise at LIGO sites, point design spreadsheets, low-frequency limit to interferometry, control analysis of the JILA active isolation system, design considerations for LIGO suspensions, notes from visits to GEO lab, detailed transfer function modeling, status of the GEO600 suspension design, materials for suspensions, and experiment to make a direct measurement of substrate thermal noise and excesses, magnetic suspensions, silicon and sapphire bonding methods
 - > notes to appear on LIGO Web site (or ask dhs)
- basic plan outlined in Adv R&D proposal supported
- action items developed
 - > dhs: to distribute key LIGO environment, design documents

Next meeting

- in fall
- probably in conjunction with a first LSC meeting
- Summary: functional working group, targeted on LIGO needs;
- LIGO Lab playing a central role

MIT Lab proposal

LIGO plans range of activities in suspensions etc.

- modeling
- design
- table top testing
- high-sensitivity measurement of prototypes
- qualification

MIT proposes to become center for this research

- in particular, for full-scale measurements
- expect some activity also at CIT
- Mike will discuss facility
- focus here on medium-term plans impacting MIT facility
- small-scale experiments, modeling, associated (MIT/CIT)

Research to have strong collaborative element

- of course and first: within Lab (CIT/MIT)
- important to bring more hands to bear on problems
- significant activity in GEO, Stanford, JILA, PennState, Syracuse...
- desirable to have facilities within LIGO Lab

Responsibility and constraint

- requires human and physical infrastructure
- will lead to limits to time for bluesky research in a vacuum facility

Outline of plan

2003 Double pendulum advanced subsystem is focus

Near-term

- development of requirements
- establish boundary conditions and interfaces
 - > present stacks?
 - > present optics size?
- establish criteria for choosing configuration
 - > number of masses/reaction masses
 - > actuation philosophy: act on test mass?
 - > thermal noise

FALL 98

- perform up-front proof-of-principle tests as modeling indicates:
 - > actuator noise/dynamic range
 - > control hierarchy
 - > suspension fiber resonances; wire sensing/damping schemes
 - > Qs for translational (H,V) and rotational modes
 - > some can be performed in individual tanks of vacuum system
- build initial prototypes
 - > full-scale
 - > possibly targeting only control, or Q, or seismic filtering

Outline of plan

SUMMER 99

- test in suspended cavity(ies) in MIT facility
- control and isolation transfer function test targeted
- length and alignment

SUMMER 00

- test of multiple suspensions
- acquisition characterized

SUMMER 01

- test of complete FP-MI ifo, double suspensions
- full displacement sensitivity
- possibly also testing optical configurations
 - > (post-modulation?)

SUMMER 02

- qualification of suspension design
- final design
- fabrication

40m R&D - Longer Term Options

S. Kawamura



40m Future Plan

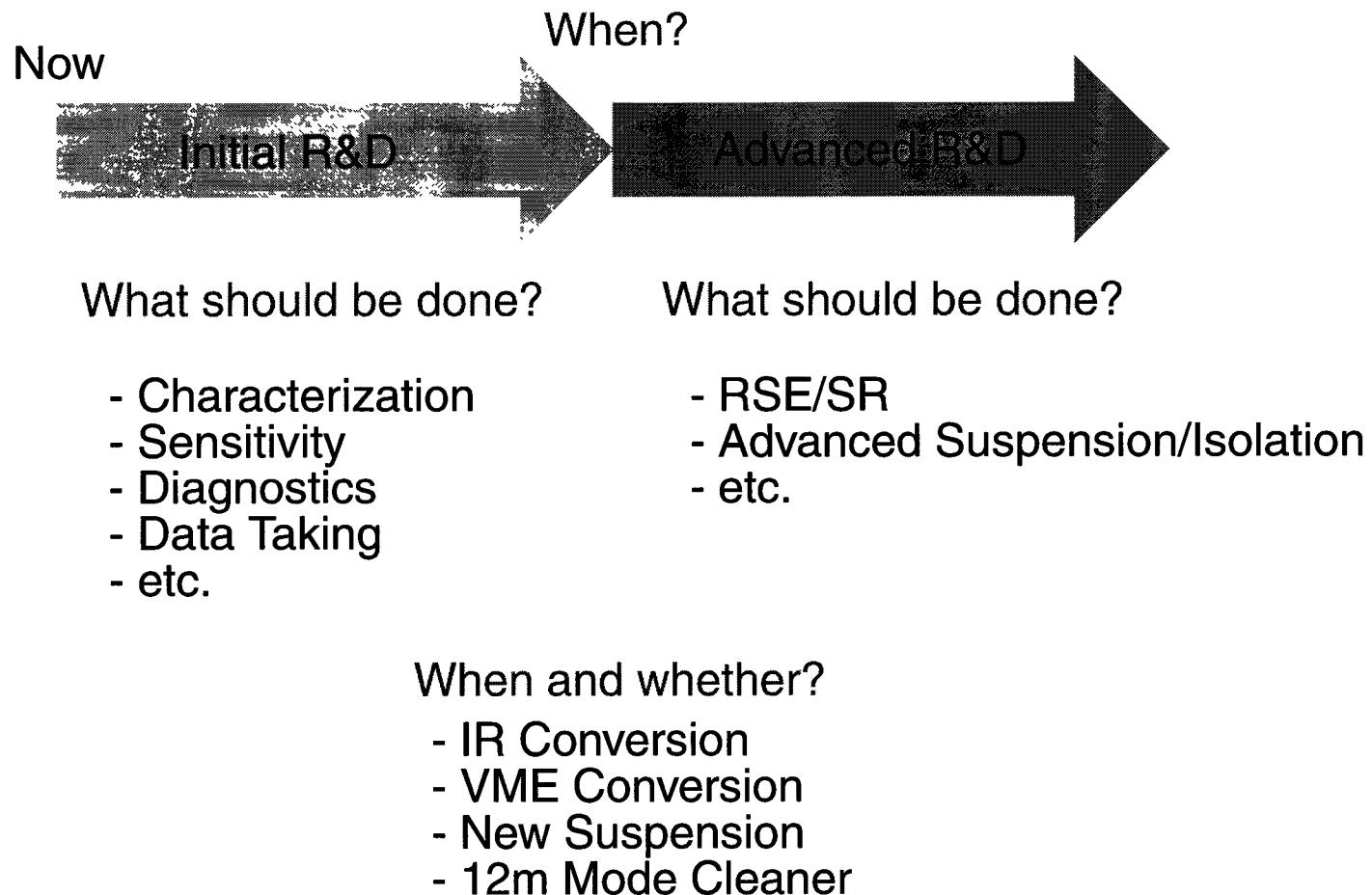

40m Future Plan Options

Options	Advocate	97	98	99	00	01
R&D for Very Advanced Technique	Whitcomb	Recycling - Characterization - LIGO Test	IR Conversion VME Conversion New Suspension	RSE/SR Sapphire Test Mass		Squeezing Adaptive Narrow band
Pathfinder for LIGO Technology	Spero	Recycling - Lock Acquisition - Sensitivity - Wavefront Sensing	Hardware & Software for Stability and Robustness - VME Conversion - New Suspension - Diagnostic Procedures, Control, and Archiving		IR Conversion RSE/SR	
Data Taking and Diagnostics	Lazzarini	Recycling Characterization Data Taking	Diagnostics & Availability Research - VME Conversion - New Suspension	IR Conversion	RSE/SR	

DETECTION RANGE FOR NEUTRON STAR CHIRP SIGNAL

Table 1:

	SNR = 6, Random Polarization	SNR = 3, Optimum Polarization
Initial LIGO	11 Mpc	50 Mpc
40 m scaled to 4km (Oct. 94 disp. sens.)	1.6 Mpc	7 Mpc

Thermal Lensing in the Core Optics

Results from FFT Model

W. Kells



Table 3: Summary table of relative thermal distortion amplitude

6 WATTS INTO RM
GCR ≈ 50

Optic	dn/dT		Thermo-elastic		
	Bulk heating	Surface heating	Bulk OPD	Surface deformation	dR/R
ETM	----	-----	-----	.03 G	.004
ITM	.01 A	.08 B	.05 C	.03 D	.0025
BS	.3 - .6 E	.006 - .012	.01 - .02 F	< .0002	-0
RM	.06 - .012	.012	.006 - .012	< .001	

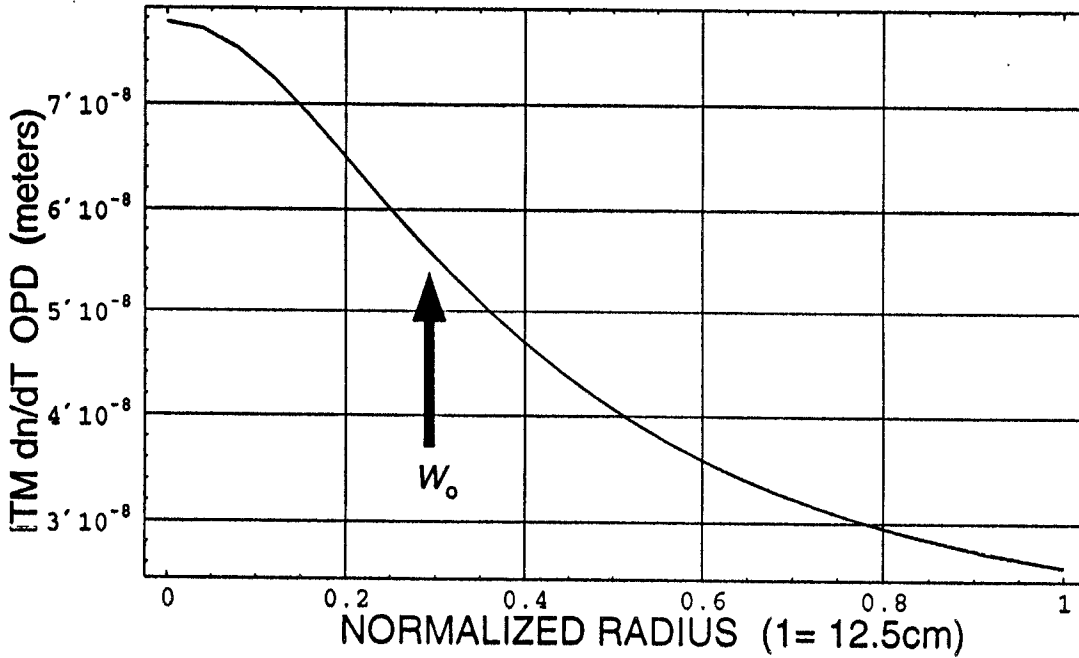
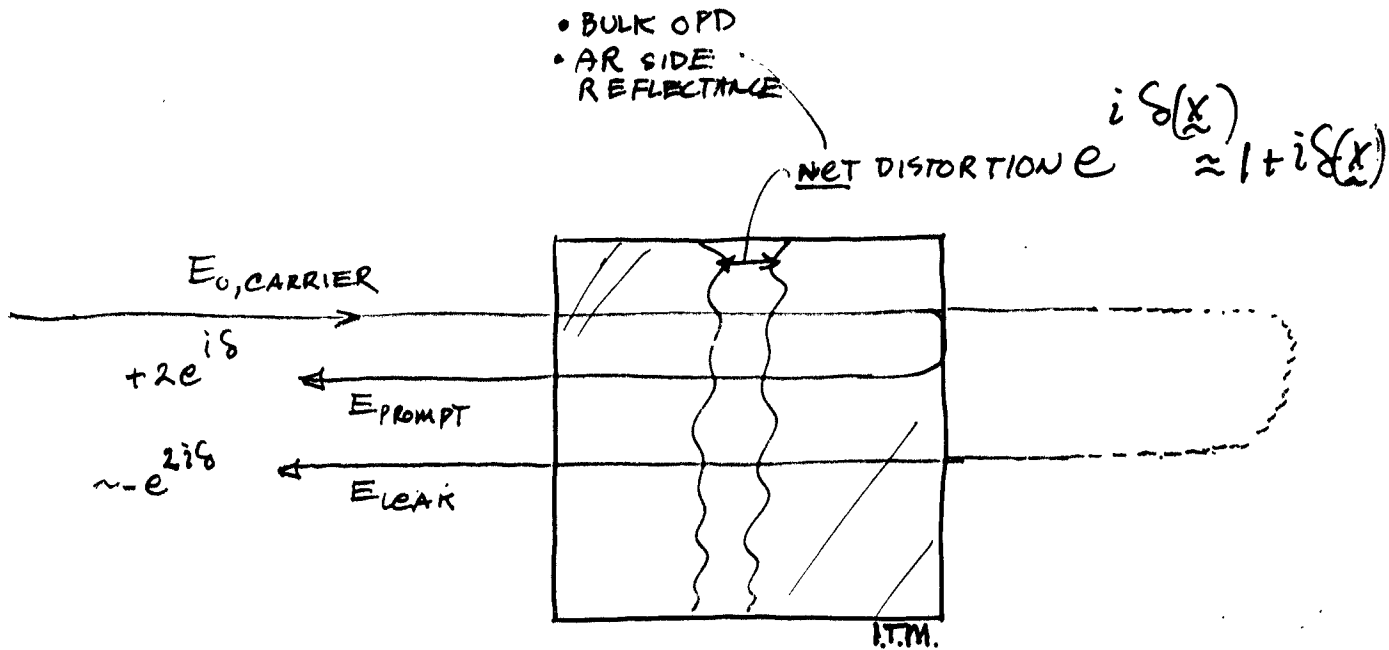

Table 2: decomposition description of Fig. 2 deformation (in nano-meters)

fit radius cm	ITM design Z ₂	Deformation shape						
		Z ₂	Z ₄	Z ₆	Z ₈	Z ₁₀	rms	PV
12.5	-268	-17.4	10.9	-5.97	3.89	-2.4	11.5	51.4
w ₀	-14.5	-7.24	0.46	-0.15	0.0002	0.0	4.23	14.4
2w ₀	-58.1	-16.8	4.53	-0.67	0.046	-0.0012	9.92	34.8

R.C. DISTORTION APPROXIMATION

- R.C. DISTORTIONS HARDLY EFFECT CARRIER
- THIN, SMALL PERTURBATION APPROX
- ~ OK FOR ITM BULK, r vs r_{AR} MAPS : BUT FOR BS. ?



E_{PROMPT} : DOUBLE PASS

E_{LEAK} : (-) phase AND ~ 2X AMPLITUDE } CANCEL

NOT SO FOR SB's

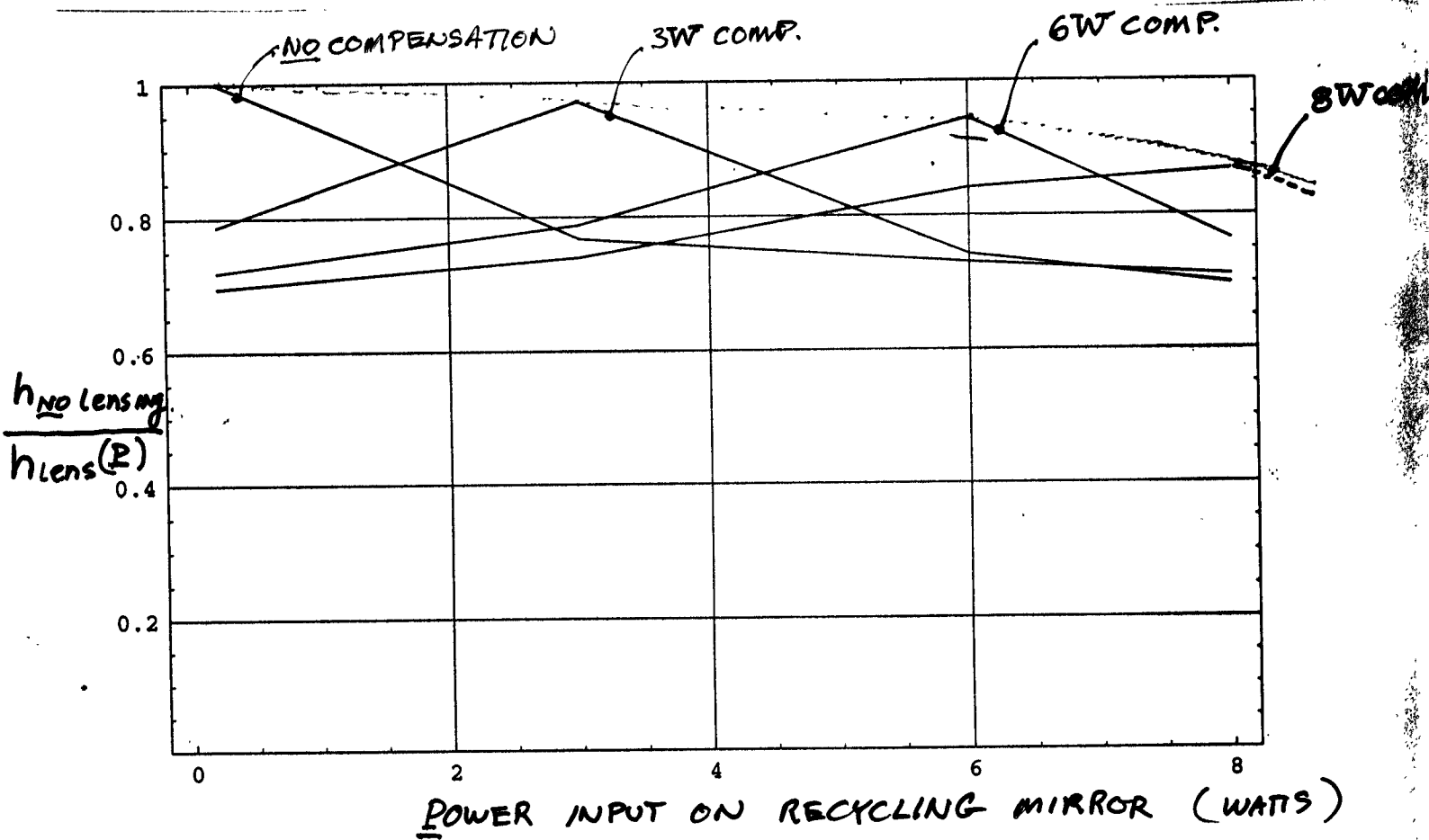

- $G_{CARRIER} \approx \text{CONSTANT}$ (WITHIN $\pm 2\%$) $\Rightarrow R_{RM} \equiv \text{CONST.}$

- L_{SCHUPP} OPTIMIZED: VARIES: 11CM \rightarrow 35CM

- COLD START FOR 6W COMPENSATION: $P_{SD,00}$ TO RP. $\approx 8\%$

- Γ OPTIMIZED: VARIES .26 - .44

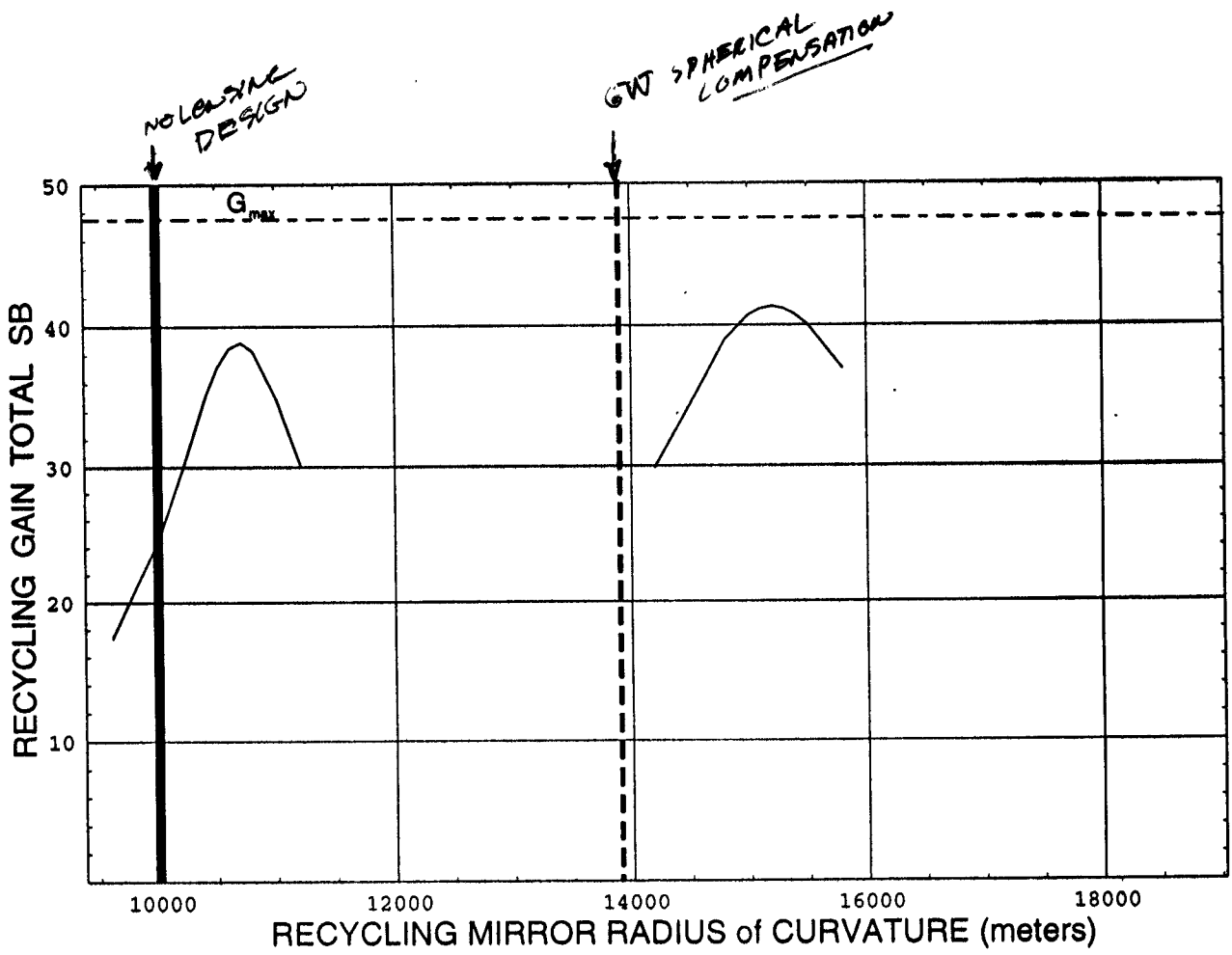

Contamination Studies

D. Shoemaker, J. Camp



Contamination

Science/Integration 23 May 97 dhs

Stimulus:

- 10 ppm scatter loss and 1 ppm absorption.
- corresponds to $\sim 0.1 \text{ \AA}$ of carbon on the optic surface.

Scope

- the establishment of an ordered list for testing based on technical and schedule considerations,
- design and construction/installation of measurement systems data collection and analysis,
- requirements to be imposed on optically contaminating substances based on the research,
- the delivery of a list of acceptable materials and exposures.

Two approaches will be followed in parallel, close coordination

- Optical exposure testing (Ring down and variants)
- Non-optical analysis - direct measurements of contaminant partial pressures and related parameters

Ordered list for testing

- Kapton ribbon cabling
- Epoxy
- Viton O-rings
- Suspension actuator/sensor head components
- Lubricants
- Teflon/Vespel
- Other materials and relevant procedures to follow:
 - > mirror cleaning procedures
 - > air bake procedure
 - > solder
 - > Faraday isolator components
 - > RTV pellets
 - > alternatives to the present epoxy (e.g., low temperature metals)
 - > components discussed in the Virgo documentation
 - > translation stage (anticipated for IOO)
 - > gowns and other paraphernalia used in the vacuum systems at atmospheric pressure

Sensitivity

- guess that less than 1/100 of a monolayer 10^{13} molecules/cm² is most likely safe
- The worst cases would be those where the molecule increases its non linear polarizability by being adsorbed on the surface.
 - > less likely at 1 micron where the frequency doubles photon would only be 2 ev. Still below most surface work functions and less danger of photo ionization.
- don't know the accommodation coefficient of the hydrocarbons (probability of sticking).
- For a heavy hydrocarbon this could be close to 1 so that every molecule hitting the surface sticks.
- The number of molecules/sec/cm² hitting the surface is $(\rho v)/4$ where ρ is the particle density in the vapor = $3 \times 10^{16} P$ (in Torr), $v =$ the velocity $4 \times 10^4 / \left(\sqrt{\frac{\text{amu}}{28}} \right)$ cm/sec.
- for say 10^{-13} torr and a year with amu = 100, get close to a monolayer/year.
- RGA has sensitivity $\sim 10^{-15}$ torr in counter mode.

Beyond RGAs

Increasing the sensitivity

- orifice to reduce pumping speed
- accumulation at room temperature - close valve to pump
- accumulation with temperature cycling
 - > LN2 trap can be blown out

Other instrumentation/measurement techniques

- crystal deposition monitor
- Auger analysis
- XPS, SIMS,
- X-ray backscatter

Vacuum system

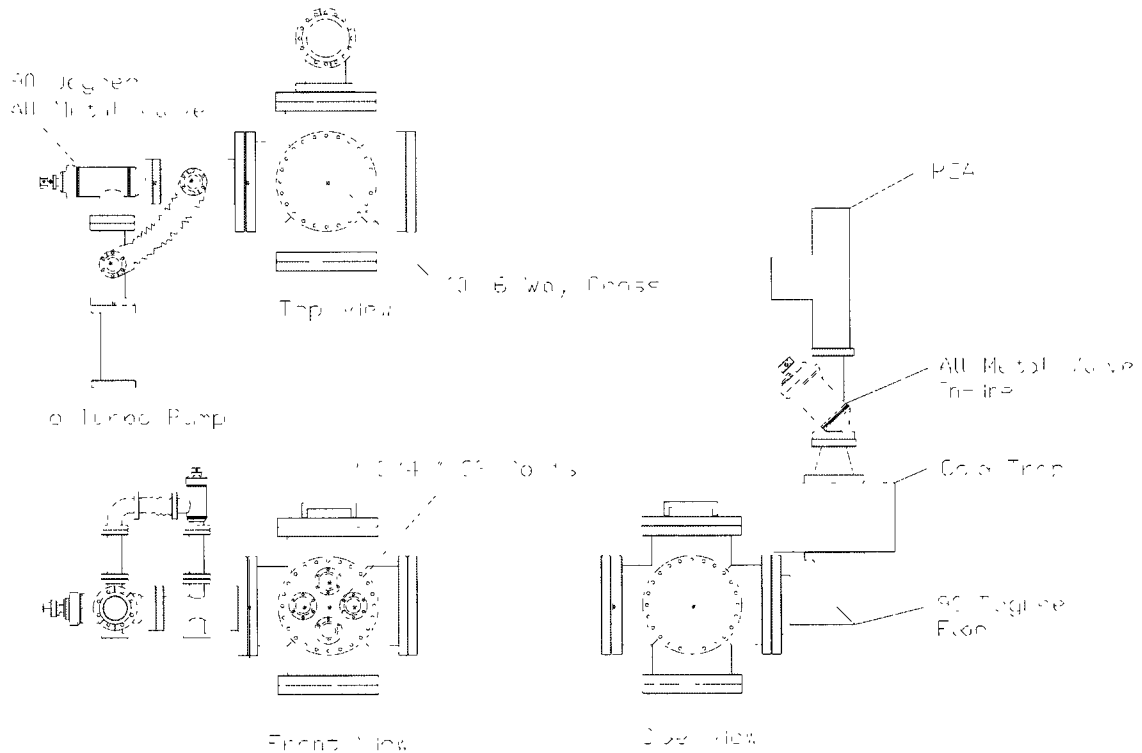

Vacuum Chamber, Containment, Trapping

- based on 10" 6-way cross
- RGA, gauges, cold trap, calibrated leaks, bakeout oven
- maybe Crystal monitor
- most parts in house, mostly assembled
- oven is one remaining question

Schedule

Table 1: Non-Optical Contamination Test Schedule

Task	Person	M	A	M	J	J	A	S	O
Vacuum procurement, fab	1/2 time	x	x	x					
Qualification	1/2 time				x				
Sample procurement, plan	1/2 time	x	x						
Setup/test plan Review					x				
First tests	1/2 time				x	x			
First test review						x			
Second tests	1/4 time					x	x		
Second test review							x		

not impossible to do qualification in June

- depends on oven solution (last piece missing)

Possible Elimination of Some HAM SEI Subsystems

S. Whitcomb



Possible Elimination of Some HAM Seismic Isolation Stacks

Stan Whitcomb

23 May 1997



CALIFORNIA INSTITUTE OF TECHNOLOGY
MASSACHUSETTS INSTITUTE OF TECHNOLOGY

Very Abbreviated History

- 1989 Proposal outlined initial and advanced vacuum chamber configurations (intended to house “plausible” IFO’s)
 - ›› “Phase A” configuration included 9 HAM chambers per interferometer
 - ›› “Phase C” configuration included 14 HAM chambers per interferometer
- 1994 Vacuum Equipment specification reviewed and released
 - ›› Configuration included 6 HAM chambers per interferometer (3 input, 3 output)
 - ›› Input: 12 m Modecleaner (2 chambers), Recycling Mirror (1 chamber)
 - ›› Output: Reducing optics (1 Chamber), 12 m Modecleaner (2 chambers)
- Current interferometer design does not include output MC
 - ›› 2 HAM’s per interferometer are unused



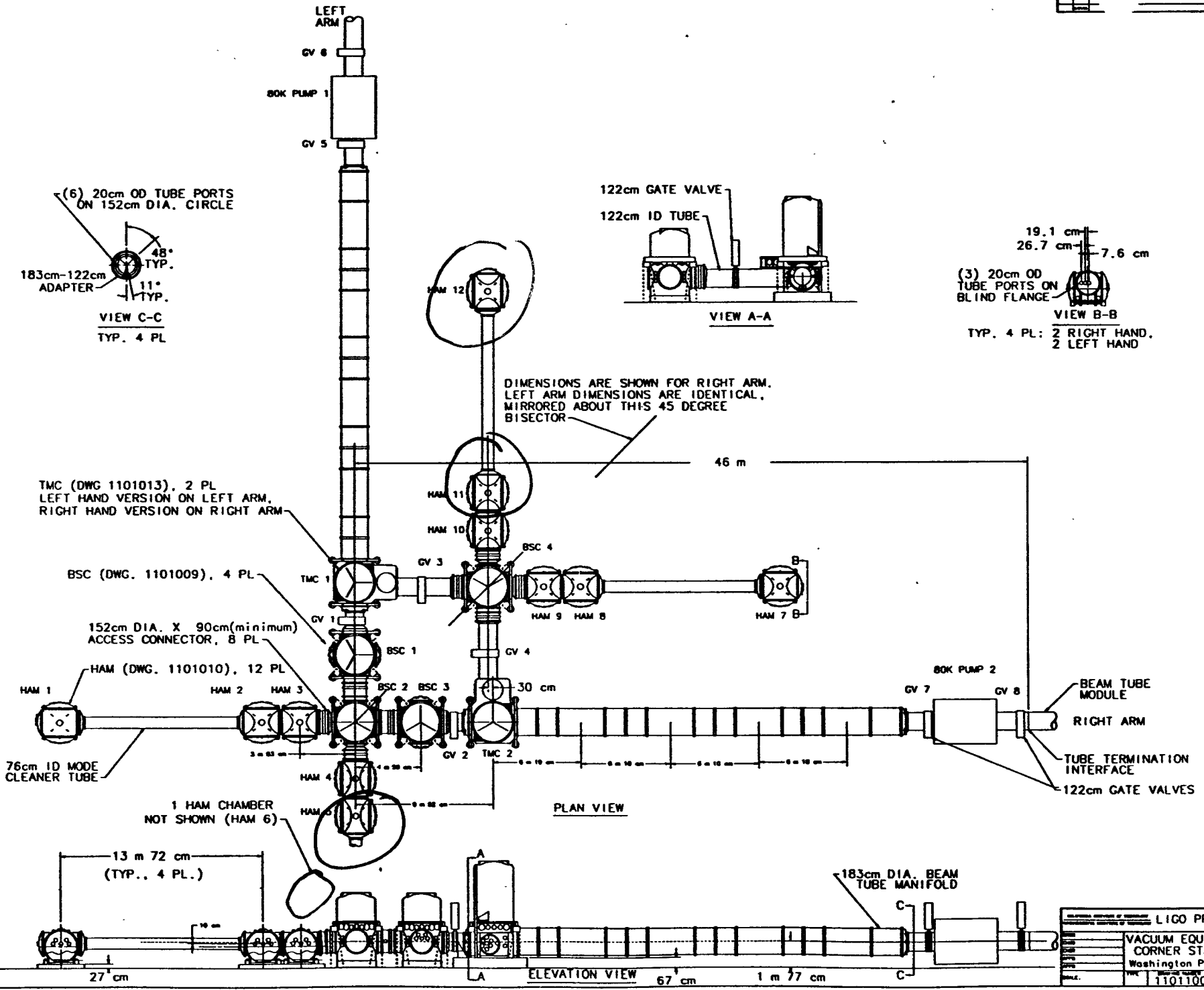
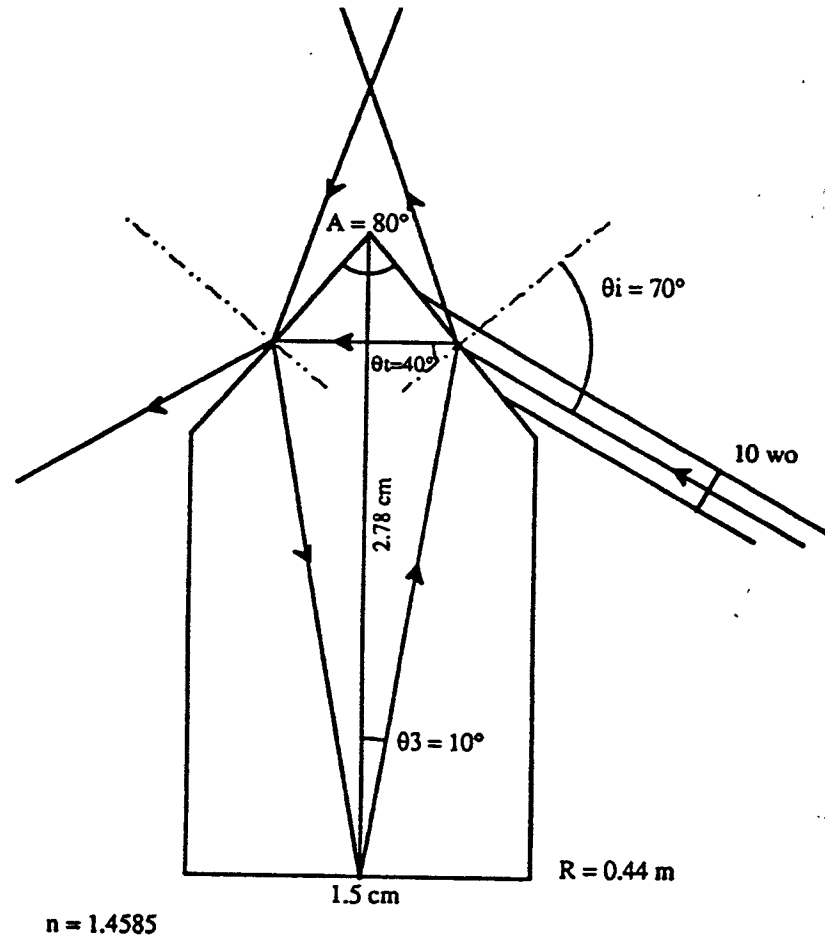

Figure 4.

VIRGO Output Modecleaner



Potential Savings

- Possible options: Eliminate 0, 1, 2 HAM stacks for each interferometer
- Each HAM stack costs \$202 k
 - ›› Total Savings up to \$1.2 M
- Deferring fabrication/installation improves schedule contingency for commissioning
- May want different type of stack later



Possible Problems

- Delays if we need to add something
- Possible contamination of vacuum system/interferometer during heavy installation
- Loss of fabrication skills by custom vendors (springs)
- Increases costs of later enhancements



Questions

- Does anyone see a near-term need for additional space at interferometer output?
- Are we confident that these stacks are what we will want when we finally do want the space?
- How high is the cost (dollars, disruption, whatever) if we defer the fabrication/installation of some output stacks until needed?
- Any other thoughts?

