



## Statement of Work TMS Suspension Springs C1200457-v3

### 1.0 Scope (LIGO sub-system)

This Statement of Work covers the manufacturing of two types of maraging steel 'thin' curved blade springs according to LIGO Specification [E0900023-v11](#), sections 1 through 2.4. Parts will be manufactured from LIGO supplied material.

### 2.0 Document Access

Many supplemental documents and specifications are incorporated into and made a part this Statement of Work. Click on the document links to access these documents from the LIGO Document Control Center (DCC) or go on line to the LIGO Public DCC at <https://dcc.ligo.org/> to access the DCC#.

### 3.0 Commercial Terms and Applicable LIGO Specifications:

**Note: The documents listed below are invoked for this Statement of Work and comprise additional requirements which are integral to this Statement of Work.**

- [LIGO-C080185-v1](#) LIGO Commercial Items or Services Contract General Provisions
- [LIGO-Q0900001-v5](#) Advanced LIGO Supplier Quality Requirements
- [LIGO-E0900023-v11](#) Process for Manufacturing Cantilever Spring Blades for AdvLIGO

### 4.0 Quality System:

Referring to the above referenced LIGO Specification Q0900001, Suppliers should include a copy of their current ISO 9001, AS9100, or TS16949 certification in their bid package. Suppliers lacking current certification should send a copy of their Quality Manual with their bid package.

### 5.0 Parts to be manufactured, Quantity Required, and Inspection requirements:

Drawing #	Part Description	Total Qty:	Parts to be Inspected
<a href="#">LIGO-D1200116-v2</a>	aLIGO TMS Upper Stage Blade Spring	21	Serial #'s 001 thru 021 (All Parts)
<a href="#">LIGO-D1200117-v2</a>	aLIGO TMS Lower Stage Blade Spring	21	Serial #'s 001 thru 021 (All Parts)

**Notes:**

- (1) Refer to section 7.6.1 of this SOW for scope of inspection required.
- (2) See section 7.7 for Part Number and Serial Number marking requirement.

### 6.0 Manufacturing Facilities, Equipment, and Capability:

LIGO personnel will inspect the supplier's facilities and equipment to ascertain that the supplier possesses adequate and appropriate facilities, equipment, and capability for the stated work. Supplier

must insure that all sub-contractors have the necessary facilities, equipment, and capabilities for the sub-contracted work. LIGO reserves the right to inspect all sub-contractors' facilities.

## **7.0 Manufacturing Requirements:**

### **7.1 Fabrication:**

**7.1.1** All parts are to be manufactured in strict accordance with LIGO Specification [E0900023-v11](#), and all additional requirements of this SOW, except for section 2.5, section 2.6 and section 3.0 of [E0900023-v11](#). (Supplier is not responsible for nickel plating or hydrogen embrittlement bake as per section 2.5 and section 2.6 of [E0900023-v11](#).)

All parts are 'thin' curved springs as described in section 2.2 of LIGO Specification [E0900023-v11](#).

Supplier is responsible for all sub-contractors' conformance to LIGO Specification [E0900023-v11](#) wherever applicable, including handling and protection of parts, and to all additional and applicable requirements of this SOW.

**7.1.2** Included with price and delivery quote, supplier will supply a complete outline of the intended manufacturing process.

**7.1.3** For each completed part, all surfaces including holes and sides, must be finished to a 63 µinch Ra [1.6 µm Ra] roughness maximum (not per Specification [E0900023-v11](#) which specifies 32 µinch Ra [.8 µm Ra] roughness maximum).

**7.1.4** All completed parts must consist of 100% virgin material, free of repairs such as plugs or welds.

### **7.2 Material:**

LIGO will supply the raw material for all parts from stock on hand. This material is Maraging Steel C-250, circa 2002 per AMS 6512D, .27 inch thick sheet.

NOTE: LIGO Specification [E0900023-v11](#), section 2.1, requires Maraging Steel C-250 per AMS 6520. This discrepancy is noted and approved by LIGO.

### **7.3 Tooling:**

**7.3.1** LIGO possesses some tooling specifically for production and inspection of the parts of this SOW. This tooling may be useful to the supplier and is available for their use. This tooling will remain the property of LIGO.

**7.3.2** Supplier will supply all further necessary tooling for production and inspection of the parts. This tooling, for an agreed NRE, will be the property of LIGO.

### **7.4 Sub-Contracted Work:**

LIGO expects that at least 2/3 (by dollar value) of the contracted work be performed by the Supplier named on the Purchase Order. All sub-contracted work shall be done in accordance with the manufacturing process agreed to prior to award of prime contract. The Supplier shall be responsible for all sub-contracted work.

## 7.5 Precedence:

If any conflict is perceived among the drawings and other invoked documents of this SOW (see section 3.0 for other invoked documents), the supplier is requested to contact a LIGO representative for resolution.

## 7.6 Inspection of Parts:

LIGO reserves the right to source inspect at supplier's facility after:

- flat fabrication
- rolling (curve forming)
- heat treat

**7.6.1** All completed parts (Serial Numbers 001 through 021 for both Part Numbers) shall be inspected by the supplier for full conformance to the specifications of the drawings, except as stated in section 7.1.3 of this SOW.

**7.6.2** Prior to delivery, supplier will provide complete drawing conformance inspection reports for all parts according to Part Number and Serial Number. See section 8.0, this SOW.

## 7.7 Marking of Parts:

Each part is to be numbered in an approximate location as noted on the drawing. Marking is to be scribed, engraved (a vibratory tool may be used), or laser applied. No inks or dyes are permitted. Marking shall consist of part number with revision, followed by a three digit serial number. Serial numbers shall start at 001 and proceed consecutively. Character height shall be .10" minimum.

Example: D1200116-V2 S/N 004

## 7.8 Manufacturing Environment and Protection of Parts:

**7.8.1** LIGO personnel will initially inspect the supplier's facility to ascertain acceptable moisture control, general air quality control, and general facility cleanliness control. All sub-contractors must agree that LIGO may similarly inspect their facilities.

**7.8.2** Parts must be protected from moisture at all times up to and including time of delivery. These requirements apply to all sub-contractors, and supplier is responsible for all sub-contractors' conformance to them. These requirements are in addition to the various protection and special handling requirements throughout LIGO Specification [E0900023-v11](#).

## 8.0 End Item Data Package:

Before delivery of the parts, the Supplier shall provide the following data, as a minimum:

- Any as-built modifications (with approval of the LIGO Contracting Officer) as mark-ups to the drawings
- Heat Treat and/or Stress Relief certifications, if applicable
- Inspection reports according to Sections 5.0 and 7.6.1&2 of this SOW
- Certificate of compliance for each part number stating conformance to contract and drawing requirements

## **9.0 Delivery Requirements:**

### **9.1 Shipping Containers and Packaging:**

The contractor is responsible for providing shipping containers and transportation which protects these parts from damage from the transportation environment (weather, handling, accidents, etc.). Mating edges of parts should be especially protected from damage during shipping.

### **9.2 Shipping Destination:**

The deliveries are FOB at these destinations, i.e. the Supplier has the responsibility for shipping title and control of goods until they are delivered and the transportation has been completed. The contractor selects the carrier and is responsible for the risk of transportation and for filing claims for loss or damage.

These items will be shipped to:

#### **California Institute of Technology (CIT)**

attn: Ken Mailand  
LIGO Project MS 100-36  
391 S. Holliston Ave.  
Pasadena, CA 91125

### **9.3 Delivery Schedule:**

LIGO desires to receive (at the address cited in 9.2 above) *at least* 4 pieces of each part number within 8 weeks ARO and the balance within 12 weeks ARO. Please quote the best delivery that you are confident of achieving, even if it exceeds the desired delivery time. Among other factors, the quoted delivery time will be a consideration in the award selection process.

8

7

6

5

4

3

2

1

NOTES CONTINUED:  
 5. SCRIBE, ENGRAVE (A VIBRATORY TOOL MAY BE USED), LASER MARK OR MECHANICALLY STAMP (NO INKS OR DYES) DRAWING PART NUMBER, REVISION (AND VARIANT OR "TYPE" IF APPLICABLE) ON NOTED SURFACE OF PART FOLLOWED ON THE NEXT LINE WITH A THREE DIGIT SERIAL NUMBER. SERIAL NUMBERS START AT 001 FOR THE FIRST ARTICLE AND PROCEED CONSECUTIVELY. USE MINIMUM 0.12" HIGH CHARACTERS, UNLESS THE SIZE OF THE PART DICTATES SMALLER CHARACTERS. EXAMPLE: DXXXXXX-VY, TYPE-XX, S/N XXX

6. MASS: 2.074 LB [0.941 KG].

7. FROM STATEMENT OF WORK C1200457-v3:

ALL PARTS ARE TO BE MANUFACTURED IN STRICT ACCORDANCE WITH LIGO SPECIFICATION E0900023-v11 AND ALL ADDITIONAL REQUIREMENTS OF THIS SOW. MANUFACTURER IS RESPONSIBLE FOR ALL SUB-CONTRACTORS' CONFORMANCE TO LIGO SPECIFICATION E0900023-v11 WHEREVER APPLICABLE, INCLUDING HANDLING AND PROTECTION OF PARTS, AND TO ALL ADDITIONAL APPLICABLE REQUIREMENTS OF THIS SOW.

PARTS ARE 'THIN' CURVED SPRINGS AS DESCRIBED IN SECTION 2.2 OF LIGO SPECIFICATION E0900023-v11.

8. ALL MATERIAL IS TO BE VIRGIN MATERIAL (i.e. NO WELD REPAIRS, PLUGS OR RECYCLED MATERIAL). NO REPAIRS SHALL BE MADE UNLESS APPROVED IN ADVANCE, AND IN WRITING, BY LIGO LABORATORY. REFER TO LIGO-E0900023-v11.

9. SPECIFIED SURFACE FINISH (63 μINCH Ra) APPLIES TO ENTIRE PART, INCLUDING SIDES AND HOLES. (NOT PER LIGO-E0900023-v11, WHICH SPECIFIES 32 μINCH Ra)

REV.	DATE	DCN #	DRAWING TREE #
v1	03 FEB 2012	-	-
v2	28 FEB 2012	E1200070	-
-	-	-	-

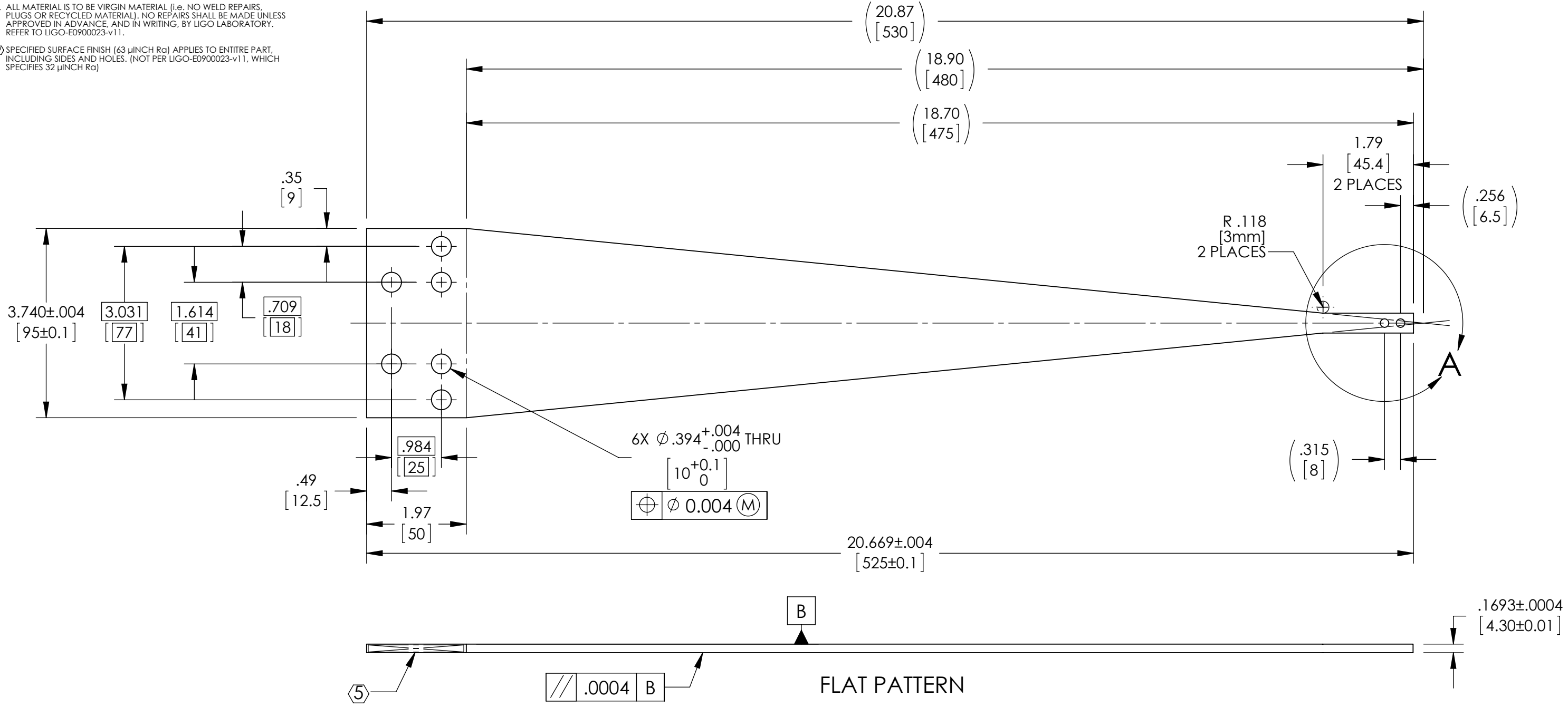
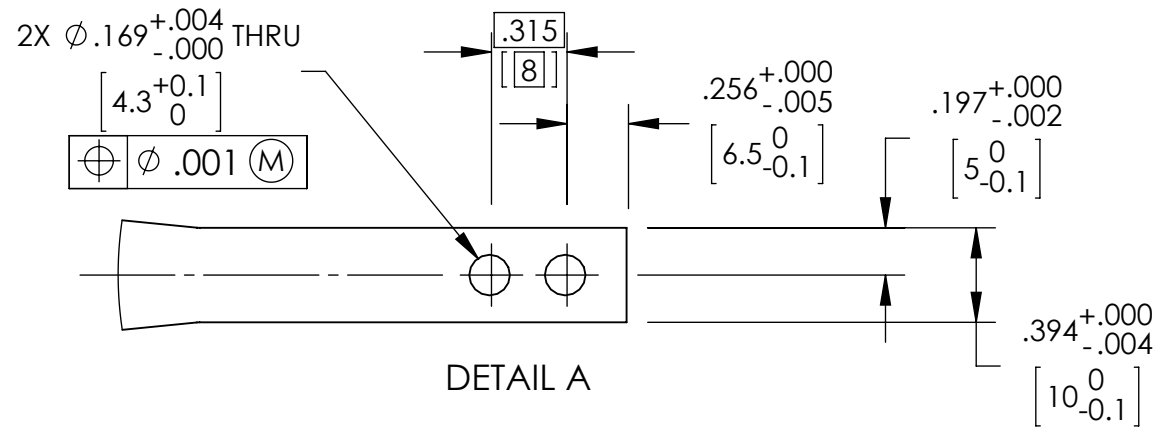

5.0004 B

FLAT PATTERN

NOTES AND TOLERANCES: (UNLESS OTHERWISE SPECIFIED)

DIMENSIONS ARE IN MILLIMETERS

TOLERANCES:  
 .XX ± .01  
 .XXX ± .005  
 ANGULAR ± 0.5°

MATERIAL: MARAGING STEEL C250  
 FINISH: 63 μinch Ra (9)

CALIFORNIA INSTITUTE OF TECHNOLOGY MASSACHUSETTS INSTITUTE OF TECHNOLOGY		PART NAME <b>ALIGO TMS UPPER STAGE BLADE SPRING</b>	
SYSTEM <b>ADVANCED LIGO</b>	SUB-SYSTEM <b>SUS</b>	DESIGNER C. CONLEY	DATE 23 JAN 2012
NEXT ASSY D1200120	DRAFTER K MAILAND	DATE 28 FEB 2012	SIZE DWG. NO. <b>B D1200116</b>
CHECKER SEE DCN	APPROVAL SEE DCN	SCALE: NONE	PROJECTION:
		REV. <b>v2</b>	SHEET 1 OF 2

D1200116 alIGO TMS Upper Stage Blade Spring, PART PDM REV: X-019, DRAWING PDM REV: X-009

8 7 6 5 4 3 2 1

D1200116 aLIGO TMS Upper Stage Blade Spring, PART PDM REV: X-019, DRAWING PDM REV: X-009

TOTAL SUSPENDED MASS ON BLADE: 63 KG

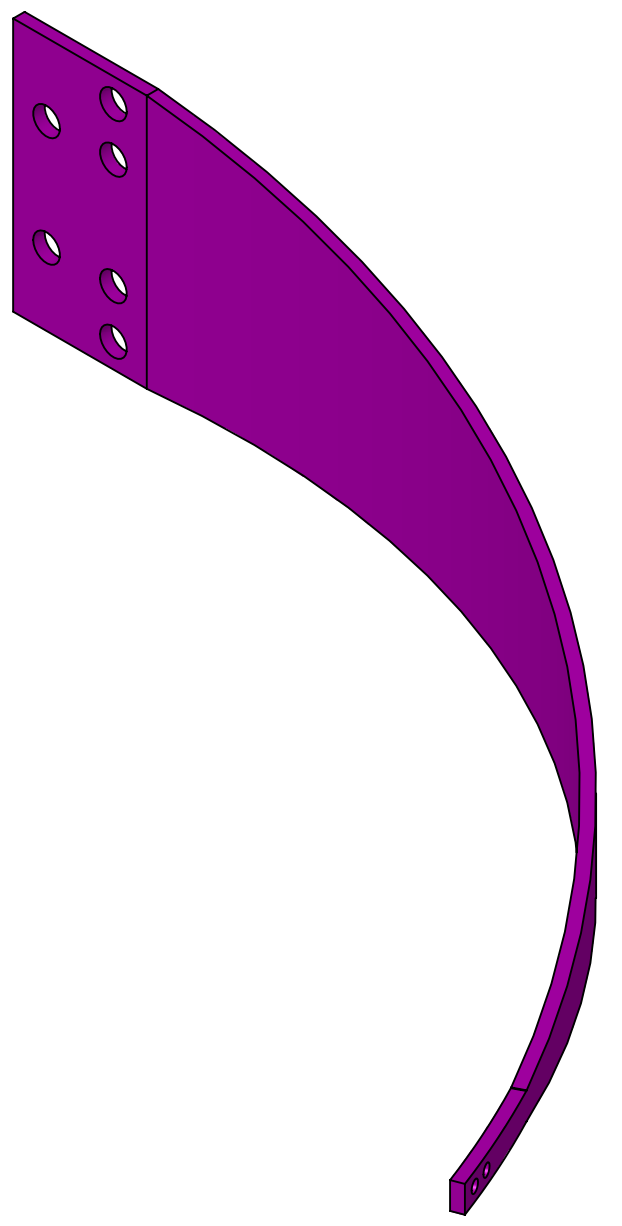
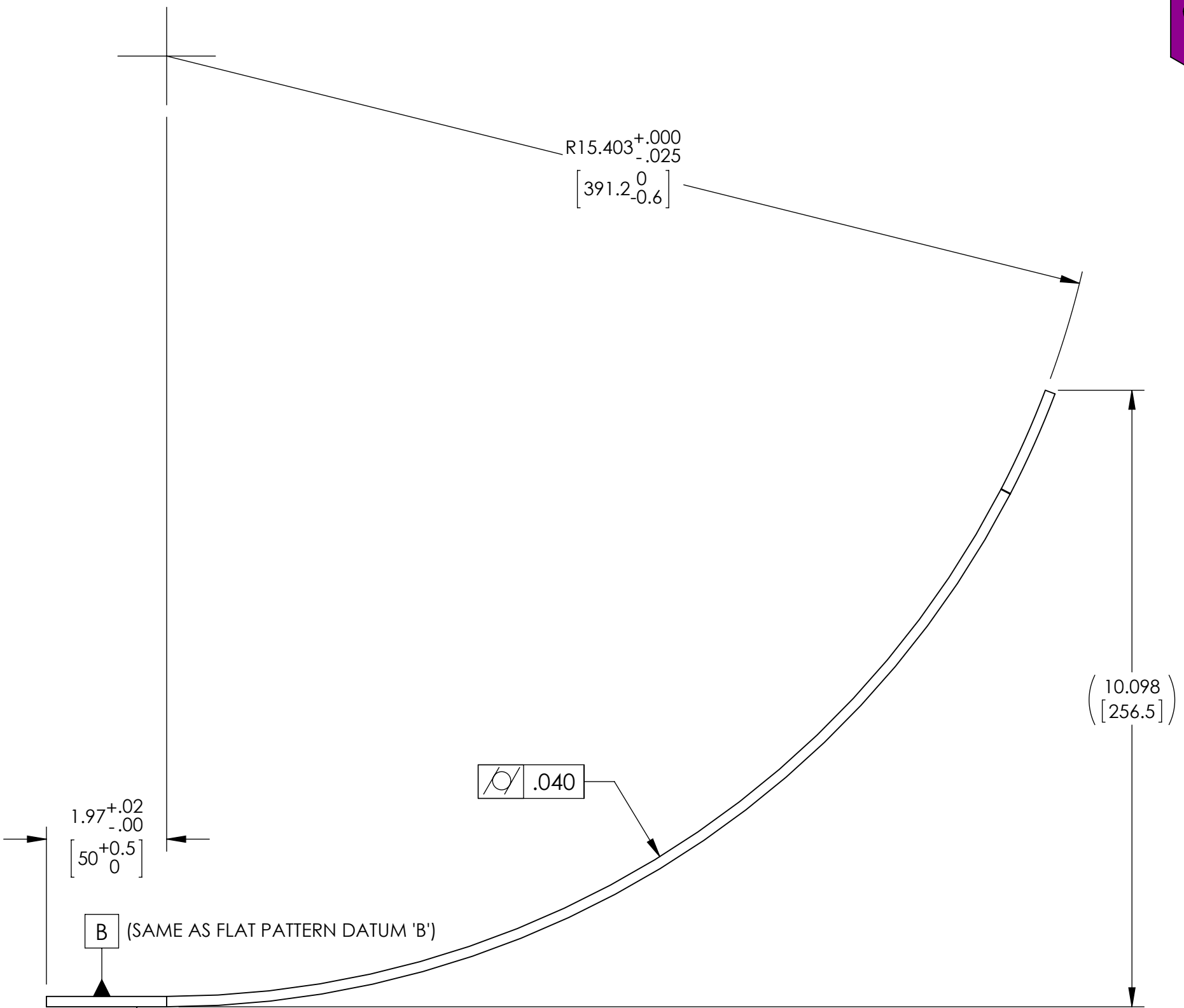
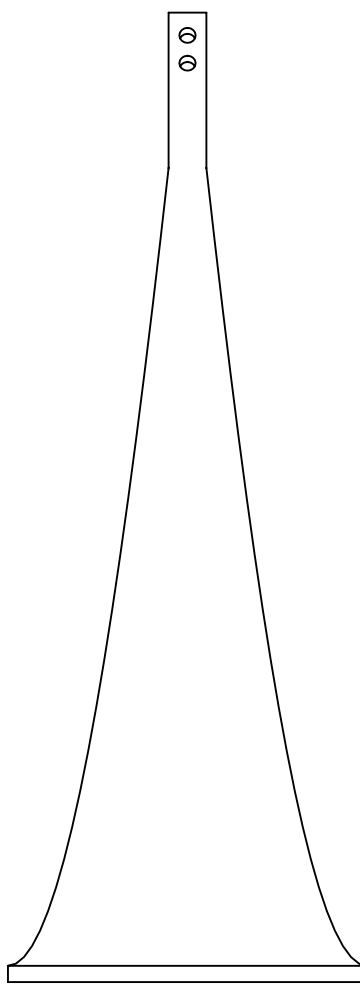

D  
C  
B  
A

D  
C  
B  
A



FORMED BLADE SPRING

/// .0004 B

 CALIFORNIA INSTITUTE OF TECHNOLOGY MASSACHUSETTS INSTITUTE OF TECHNOLOGY	
SIZE DWG. NO. <b>B</b>	D1200116
REV. v2	
SCALE: NONE	PROJECTION:  SHEET 2 OF 2

8 7 6 5 4 3 2 1

**NOTES CONTINUED:**  
 5. SCRIBE, ENGRAVE (A VIBRATORY TOOL MAY BE USED), LASER MARK OR MECHANICALLY STAMP (NO INKS OR DYES) DRAWING PART NUMBER, REVISION (AND VARIANT OR "TYPE" IF APPLICABLE) ON NOTED SURFACE OF PART FOLLOWED ON THE NEXT LINE WITH A THREE DIGIT SERIAL NUMBER. SERIAL NUMBERS START AT 001 FOR THE FIRST ARTICLE AND PROCEED CONSECUTIVELY. USE MINIMUM 0.12" HIGH CHARACTERS, UNLESS THE SIZE OF THE PART DICTATES SMALLER CHARACTERS. EXAMPLE: DXXXXXX-VY, TYPE-XX, S/N XXX

REV.	DATE	DCN #	DRAWING TREE #
v1	03 FEB 2012	-	-
v2	28 FEB 2012	E1200070	-
-	-	-	-

6. MASS: 0.789 LB [0.358 KG].  
 7. FROM STATEMENT OF WORK C1200457-v3:  
 ALL PARTS ARE TO BE MANUFACTURED IN STRICT ACCORDANCE WITH LIGO SPECIFICATION E0900023-v11 AND ALL ADDITIONAL REQUIREMENTS OF THIS SOW. MANUFACTURER IS RESPONSIBLE FOR ALL SUB-CONTRACTORS' CONFORMANCE TO LIGO SPECIFICATION E0900023-v11 WHEREVER APPLICABLE, INCLUDING HANDLING AND PROTECTION OF PARTS, AND TO ALL ADDITIONAL APPLICABLE REQUIREMENTS OF THIS SOW.  
 PARTS ARE 'THIN' CURVED SPRINGS AS DESCRIBED IN SECTION 2.2 OF LIGO SPECIFICATION E0900023-v11.  
 8. ALL MATERIAL IS TO BE VIRGIN MATERIAL (i.e. NO WELD REPAIRS, PLUGS OR RECYCLED MATERIAL). NO REPAIRS SHALL BE MADE UNLESS APPROVED IN ADVANCE, AND IN WRITING, BY LIGO LABORATORY. REFER TO LIGO-E0900023-v11.  
 9. SPECIFIED SURFACE FINISH (63 μINCH Ra) APPLIES TO ENTIRE PART, INCLUDING SIDES AND HOLES. (NOT PER LIGO-E0900023-v11, WHICH SPECIFIES 32 μINCH Ra)

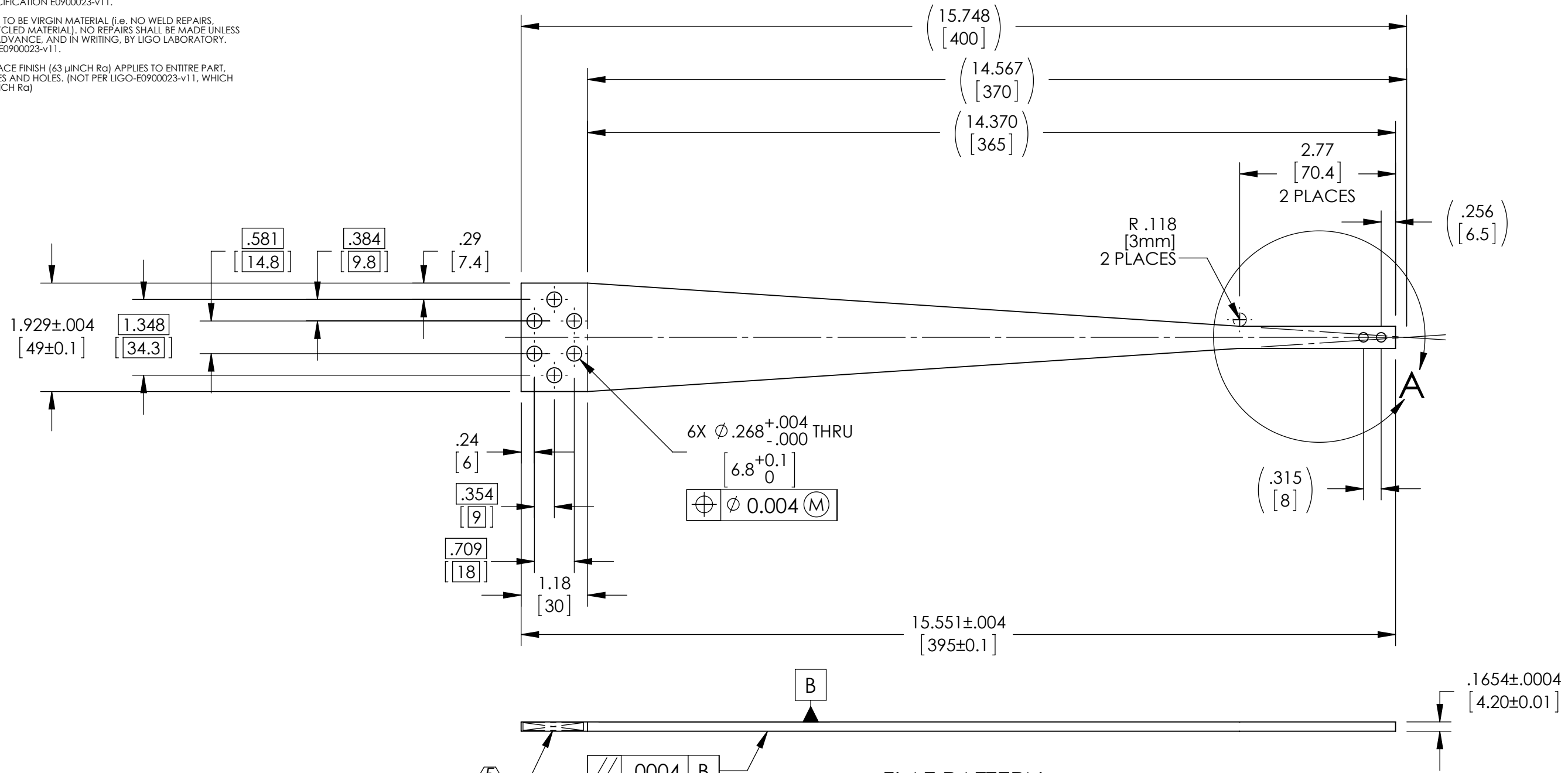
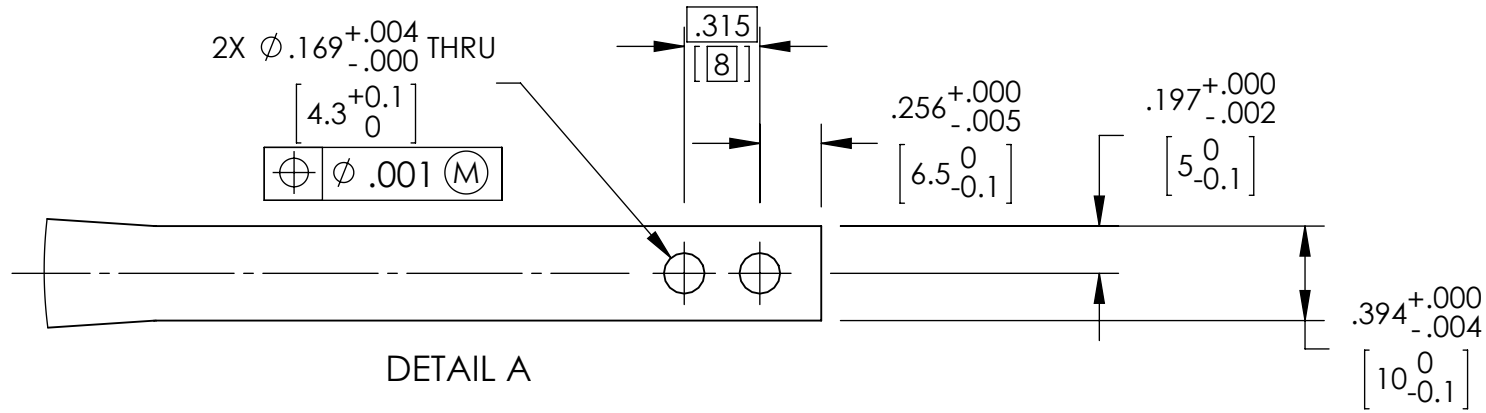

**NOTES AND TOLERANCES: (UNLESS OTHERWISE SPECIFIED)**  
 DIMENSIONS ARE IN MILLIMETERS  
 TOLERANCES:  
 .XX ± .01  
 .XXX ± .005  
 ANGULAR ± 0.5°  
 1. INTERPRET DRAWING PER ASME Y14.5-1994.  
 2. REMOVE ALL SHARP EDGES, .005-.015, FOR MACHINED PARTS. ROUND ALL EDGES APPROXIMATELY R.02 FOR SHEET METAL PARTS.  
 3. DO NOT SCALE FROM DRAWING.  
 4. ALL MACHINING FLUIDS MUST BE FULLY SYNTHETIC, FULLY WATER SOLUBLE AND FREE OF SULFUR, SILICONE, AND CHLORINE.  
**MATERIAL** MARAGING STEEL C250  
**FINISH** 63 μinch Ra (9)

**LIGO** CALIFORNIA INSTITUTE OF TECHNOLOGY MASSACHUSETTS INSTITUTE OF TECHNOLOGY  
**ADVANCED LIGO** SUB-SYSTEM SUS  
 NEXT ASSY D1000442  
**PART NAME** aLIGO TMS LOWER STAGE BLADE SPRING  
**DESIGNER** C. CONLEY 23 JAN 2012  
**DRAFTER** K MAILAND 28 FEB 2012  
**CHECKER** SEE DCN  
**APPROVAL** SEE DCN  
**SIZE** DWG. NO. B D1200117  
**REV.** v2  
 SCALE: NONE PROJECTION: SHEET 1 OF 2

D1200117 aLIGO TMS Lower Stage Blade Spring, PART PDM REV: X-012, DRAWING PDM REV: X-002

D1200117 aLIGO TMS Lower Stage Blade Spring, PART PDM REV: X-012, DRAWING PDM REV: X-002

TOTAL SUSPENDED MASS ON BLADE: 22 KG



D  
C  
B  
A

D  
C  
B  
A

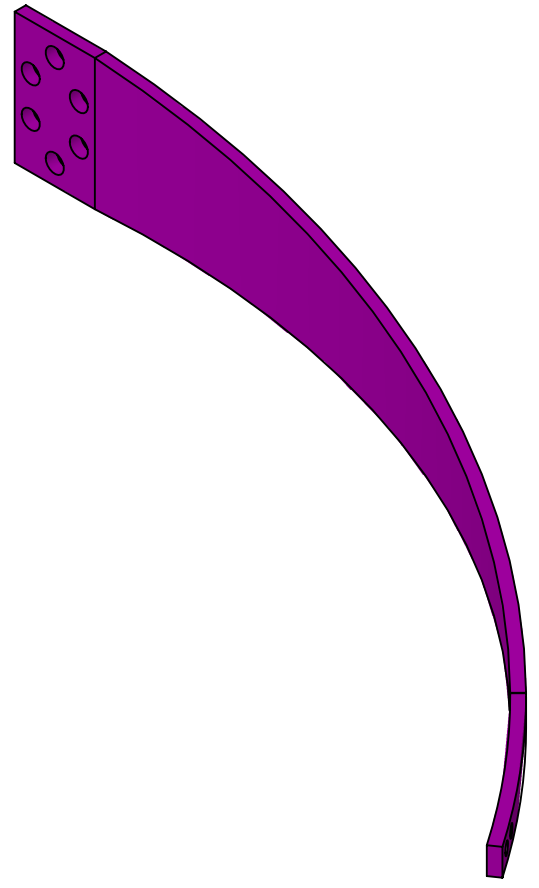
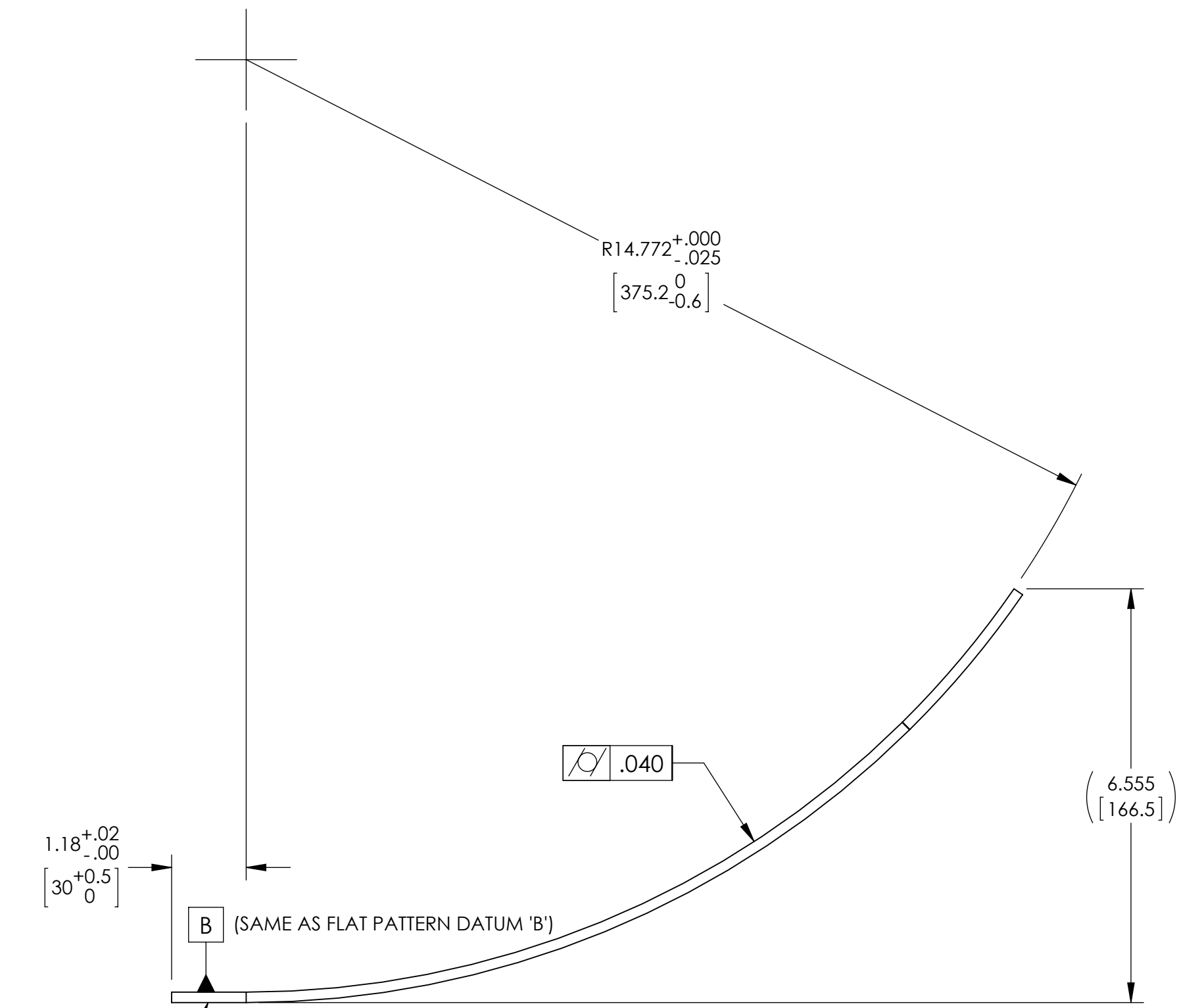
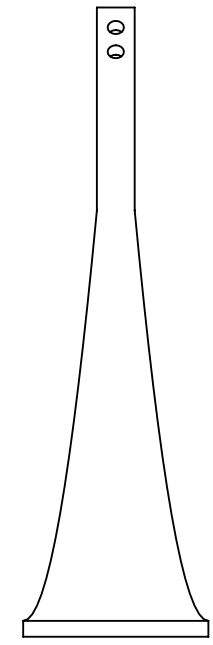
8 7 6 5 4 3 2 1



### FORMED BLADE SPRING

 CALIFORNIA INSTITUTE OF TECHNOLOGY MASSACHUSETTS INSTITUTE OF TECHNOLOGY	
SIZE DWG. NO. <b>B</b>	D1200117
SCALE: NONE	PROJECTION: 
REV. v2	SHEET 2 OF 2



	LASER INTERFEROMETER GRAVITATIONAL WAVE OBSERVATORY <b>SPECIFICATION</b>	E0900023 -v11 Document No    Rev.
		Sheet 1 of 6
	<b>Manufacturing Process for Cantilever Spring Blades for Advanced LIGO</b>	

APPROVALS	DATE
<b>AUTHORS:</b> Calum I. Torrie, Ken Mason, Dennis Coyne, Janeen Romie, Doug Cook, Mike Meyer, Mick Flanigan	12 July 2010
<b>CHECKED:</b> Dennis Coyne	12 July 2010
<b>APPROVED:</b> Dennis Coyne ( <a href="#">refer to associated DCC file card to confirm approval</a> )	12 July 2010

## 1 Scope

This process specification is for manufacture of cantilever spring blades for Advanced LIGO. It includes material requirements, limitations on shaping, detail on the nickel plating process and details of the age hardening fixture. These springs are for use in an Ultra-High Vacuum (UHV) system.

## 2 Manufacturing Process

The following is the default process. An alternative process is defined in Section 3 below. Please ask LIGO staff if this option has not been defined for you. All manufactures should respond with a summary of how they are going to follow the following processes.

### 2.1 Material

The sheet, plate or block material is called out on the associated drawing for the cantilevered spring. Materials are limited to either Maraging C-250 per AMS-6520<sup>1</sup> or Maraging C-300 per AMS 6521. The sheet or plate should be hot rolled, de-scaled and solution annealed.

The material grain direction shall be oriented parallel to the long axis of the blade spring.

Upon receipt of the material, measure hardness in several locations and verify a Rockwell C hardness of 29-33 for the annealed state. Measurements should only be performed using a Rockwell Type machine unless prior approval is obtained from LIGO staff. These measurements locations should be chosen so as not to create upsets or dimples in the final springs surfaces. Provide these measurements in certification documentation to LIGO.

### 2.2 Shaping

All shaping and forming operations are performed on the material in the annealed state with exception to the finish machining of thick springs.

The thin (< 0.4 inch, or < 10 mm), curved cantilevered springs used in LIGO suspension systems are ground to the required thickness, machined to plan form dimensions and then rolled to the radius of curvature defined on the associated drawing.

<sup>1</sup> Two materials that we know meet this specification are VascoMax c-250 (Allvac, an Alleghany Technology Company) and Marval 18 (Albert & Duval).



## Manufacturing Process for Cantilever Spring Blades for Advanced LIGO

The thick ( $> 0.4$  inch, or  $> 10$  mm) cantilevered springs used in the LIGO seismic isolation systems are either flat or curved. The flat springs are machined  $.010 - .015$ " oversize then age hardened per section 2.7.2. After age hardening the flat blades are finish ground to final thickness. The curved blades are cut by EDM  $.18 - .20$ " oversize and age hardened per section 2.7.2. After age hardening the curved blades are EDM cut to its final shape. This procedure is necessary to remove distortions that may occur during the age hardening.

All machining fluids shall be water soluble (not simply water miscible) and free of sulfur, chlorine and silicone, such as Cincinnati Milacron's Cimtech 410 (SSTL).

Machine all surfaces to remove oxides and mill finish. Abrasive removal techniques other than Blanchard grinding, surface grinding or double disk grinding, are not acceptable. These abrasive removal techniques are acceptable only if all surfaces are subsequently electropolished to remove a minimum of  $0.0002$  in, refer to section 2.5. Any additional methods must first be approved by the LIGO Contracts Technical Representative. A surface finish of 32 microinches is required. The vendor will need to confirm this surface finish in the inspection report.

Intermediate machining and strain relief steps are acceptable.

Thoroughly clean part to remove all oil, dirt and chips.

### 2.3 Dimensional Check

Perform initial dimensional check on all dimensions, including, but not limited to the thickness at various positions along the length, the radius and the height. If the dimensions are not within the tolerances called out on the drawing, forward this information to LIGO for review.

### 2.4 Cleanliness

The cleanliness of the blade springs must be maintained during all of the following steps. When not undergoing processing, the springs must be stored in cleaned & baked, covered, stainless steel containers or wrapped in clean UHV foil<sup>2</sup>, handled only with latex gloves and exposed as little as possible to the environment.

Clean (and not previously used) latex gloves must be worn when clean parts are handled during the various processes below. If the gloves come in contact with anything other than clean surfaces, they must be replaced with new ones.

<sup>2</sup> Part # ASTM B 479, UHV Certified Aluminum Foil, All Foil, 4597 Van Epps Road, Brooklyn Heights, Ohio 44131  
(216)661-0211 Voice; (216)398-4161 Fax

	LASER INTERFEROMETER GRAVITATIONAL WAVE OBSERVATORY <b>SPECIFICATION</b>	E0900023 -v11 Document No    Rev.
	Sheet 3 of 6	
	<b>Manufacturing Process for Cantilever Spring Blades for Advanced LIGO</b>	

## 2.5 Electroless Nickel Plating

Prior to nickel plating, the parts must be electrocleaned (or electropolished).

### 2.5.1 Electropolishing or Electrocleaning Qualification

Electrocleaning/electropolishing of maraging steel must be achieved by a process that does not leave behind black spotting or streaking on the material due to improper chemical baths. Only suppliers with proven experience performing electrocleaning work on maraging steel components are to be used. In addition post electrocleaning/electropolishing inspections must be performed prior to acceptance. Suppliers without a track history can be asked to provide coupons of LIGO supplied maraging steel processed through their electrocleaning steps prior to accepting any bids, and these coupons must pass a visual inspection by the cognizant engineer and LIGO QA Officer.

### 2.5.2 Electrocleaning and Nickel Plating Process

Specific thickness and heat treatments are called out below and for that reason no specific class or grade of electroless nickel plating is defined. The following process steps are suggested. Due to outgassing concerns for UHV service, the specific process steps proposed by the plating company should be submitted to LIGO for approval. Once cleaned, the springs must be kept in a clean condition, kept covered in clean stainless steel containers, or wrapped in UHV foil and handled carefully with latex gloves both prior to and after nickel plating. Cleaning should occur just prior to plating.

1. Alkaline Soak: Alkaline Soak for 30 minutes. A new batch of soak cleaner should be used and periodically replaced. Parts should remain wet with cleaning solution and not be allowed to dry out.
2. Rinse: Rinse in clean, ambient-temperature tap water. The tanks should be drained and rinsed out prior to starting. Cross rinsing or dirty rinses are not acceptable.
3. Alkaline Electrocleaning: 20 sec Cathodic / 40 sec Anodic / 20 sec Cathodic / 40 sec Anodic / 20 sec Cathodic / 40 sec Anodic; typically using 15-20 Amps/square foot. A new batch of the electro-cleaner solution (to be specified by vendor) should be used and periodically replaced. A bath with a filtration system will be accepted as an alternative to changing the fluid (after approval from LIGO) but changing the fluid is preferred.
4. Rinse in ambient temperature tap water (step 2 above).
5. Acid Clean: Place the parts in a 30 % (by volume) hydrochloric acid at ambient temperature for a minimum of 30 sec. Leave the parts in the acid until 10 sec after uniform gassing over the surface is observed, but for not more than 2 min. A new batch of the acid solution should be used and replaced at the same time as the soak and electrocleaners.
6. Rinse in ambient temperature tap water (step 2 above).
7. Repeat electrocleaning (step 3 above)
8. Rinse in ambient temperature tap water (step 2 above).

9. Electroless nickel plate with a low (<5%) phosphor bath as called out in table 1 of ASTM<sup>3</sup> (Type III phosphorus % wt - 2% - 4%) to a thickness of 0.5 um (microns) / [0.0000197 inches]. We will accept a tolerance on the thickness from 0.4 to 0.6 microns / [0.0000157 to 0.0000236 inches]. Use a method, as called out in section 9 of the ASTM<sup>3</sup> Designation B 733-97, to gauge the time required to obtain the required thickness .
10. Rinse blades with ambient temperature, de-ionized water.

### 2.6 Bake to prevent Hydrogen Embrittlement <sup>4</sup>

The blade springs must be baked soon after plating to avoid any problems associated with hydrogen embrittlement. If the age hardening bake (see section 2.7) can begin within 1 hour of plating, then the following bake can be eliminated.

The bake to prevent hydrogen embrittlement should be carried out as soon as possible, preferably within 1 hour of the plating process but not later than 3 hours, as per ASTM B850-98 (2009). The springs should be baked 22 hours at 190-220 deg C, as per ASTM B850-98 (2009).

Handle the springs only with latex gloves and expose them as little as possible to the environment. The bake to prevent hydrogen embrittlement must occur in a clean, non-shedding oven with stainless steel surfaces, or in a clean stainless steel box insert within the oven. The preference would be to use a closed loop oven with circulating air for this step, meaning an oven where the heated air circulates in from the top and bottom and out through the sides continuously to maintain a uniform temperature.

The blades should be suspended from the holes in the narrow end of the blades to prevent contacting oven surfaces and giving uniform heating. The blades should not be stacked on top of each other.

Please include in your process sheet the time taken. The time should be from removal from rinse bath (at the end of plating process) to inclusion in oven at desired temperature. If blades are not plated within the desired time, please contact LIGO Contract officer.

### 2.7 Age Hardening Bake

Prior to aging, soak the springs in a bath of iso-propanol and either ultrasonically or manually agitate for 2 minutes. Handle the springs only with latex gloves and expose them as little as possible to the environment.

<sup>3</sup> Standard Specification for Autocatalytic (Electroless) Nickel-Phosphorus Coatings on Metals, ASTM Designation: B 733-97

<sup>4</sup> Standard Guide for Post-Coating Treatments of Steel for Reducing the Risk of Hydrogen Embrittlement, ASTM B850-98 (2009)

The springs must be mounted in a "comb" or "wire rack with pins" fixture. The fixture should be made from stainless steel, other materials should be approved by LIGO staff.. The fixture is used to maintain the shape of the blades during aging and should expose most of the blades surface area. The design of this fixture should be discussed and approved with LIGO staff prior to proceeding. The fixture must be electrocleaned and baked out at 500 degrees C for 4 hours prior to initial use.

The age hardening bake must occur in a clean, non-shedding oven with stainless steel surfaces, or in a clean stainless steel box insert within the oven. The oven (or stainless steel box if one is used) must be continuously purged with heated Argon gas at a rate of about 10 liters/min through oil-free plumbing lines and valves. A vacuum oven (1 millibar (1x10<sup>-3</sup> bar) is also acceptable for age hardening. However, an inspection of such an oven must be carried out by LIGO approved staff prior to use.

Measure the post heat treatment hardness at several locations on each blade spring. Care should be taken when making measurements, especially on the thin (< 0.2 inch, or < 5 mm) blades, and if questions arise on settings please contact LIGO staff. If measurements are taken at the clamp regions please confirm with LIGO staff the acceptable locations, since the upset/dimple created could interfere with proper clamping. Details of clamping will be provided at this time if not already received with package. Provide these measurements in certification documentation to LIGO.

### **2.7.1 Thin Blade Springs**

For suspension assembly blade springs (see section 2.2):

Age harden at 815 F (435 C) for 100 hours in an inert atmosphere and air cool.

After aging the hardness should be 48 to 52 Rockwell C.

### **2.7.2 Thick Blade Springs**

For seismic isolation assembly blade springs (see section 2.2):

Age harden at 900 F +/- 10 (482 C) at temperature for 6 hours in inert atmosphere then cool at air temperature.

After aging the hardness should be 50 to 55 Rockwell C.

### **2.8 Post-Hardening Dimensional Check**

Perform a final dimensional check on all dimensions, including, but not limited to the thickness at various positions along the length, the radius and the height. If the dimensions are not within the tolerances called out on the drawing, forward this information to LIGO for review. Provide a summary of these final dimensional checks with a certification statement of compliance with this specification.

### 3 Alternative

In the process outlined above nickel plating is performed before aging. However, it should be noted that plating after age hardening is also acceptable, but only with the addition of a 275 deg C for 24 hr bake in air, used to drive off any unbound phosphorous<sup>5</sup>. This additional bake step should be performed after the hydrogen embrittlement prevention bake (section 2.6) at the end of the nickel plating process. Alternatively, if this bake can be accomplished within 1 hour of plating it also serves the purpose of preventing hydrogen embrittlement.

The additional bake, outlined above, must occur in a clean, non-shedding oven with stainless steel surfaces, or in a clean stainless steel box insert within the oven. The oven (or stainless steel box if one is used) must be continuously purged with HEPA and carbon filtered air, at a rate of about 10 liters/min through oil-free plumbing lines and valves, depending on size of oven. A closed loop oven with circulating air is also acceptable for this step, meaning an oven where the heated air circulates in from the top and bottom and out through the sides continuously to maintain a uniform temperature.

The blades should be suspended from the holes in the narrow end of the blades to prevent contacting oven surfaces and giving uniform heating. The blades should not be stacked on top of each other.

Prior to baking to remove unbound phosphorous, soak the springs in a bath of iso-propanol and either ultrasonically or manually agitate for 2 minutes. Handle the springs only with latex gloves and expose them as little as possible to the environment.

### 4 Internal Steps <sup>6</sup>

The following steps will be performed by LIGO staff after receipt of the blade springs: -

1. Blade spring response characterization – deflection/flatness under load, internal mode frequencies, etc., [LIGO-E1000169](#)
2. Cleaning and baking (200 deg C for 48 hours) for UHV service, as per [LIGO-E960022](#), including outgassing measurements - not under load.
3. If required for noise performance, then perform a Creep bake: 120 deg C for a week, which is 168 hours. Keep blades under load during and after bake.

<sup>5</sup> Internal LIGO reference - [LIGO-L0900024-v1](#) The VRB response to nickel-phosphorous plating issues.

<sup>6</sup> This section was updated following an exchange of e-mails titled "Re: Maraging steel clean and bake p.s. - further tweak" and sent on 5th January 2010.



*LIGO Laboratory / LIGO Scientific Collaboration*

LIGO-Q0900001-v5

3 February 2010

**Advanced LIGO Supplier Quality Requirements**

Jeff Lewis, Bob Anderson, Calum Torrie

Distribution of this document:  
LIGO Scientific Collaboration  
and LIGO Suppliers

**California Institute of Technology**  
LIGO Project – MS 18-34  
1200 E. California Blvd.  
Pasadena, CA 91125  
Phone (626) 395-2129  
Fax (626) 304-9834  
E-mail: [info@ligo.caltech.edu](mailto:info@ligo.caltech.edu)

**Massachusetts Institute of Technology**  
LIGO Project – NW22-295  
185 Albany St  
Cambridge, MA 02139  
Phone (617) 253-4824  
Fax (617) 253-7014  
E-mail: [info@ligo.mit.edu](mailto:info@ligo.mit.edu)

**LIGO Hanford Observatory**  
P.O. Box 1970  
Mail Stop S9-02  
Richland WA 99352  
Phone 509-372-8106  
Fax 509-372-8137

**LIGO Livingston Observatory**  
P.O. Box 940  
Livingston, LA 70754  
Phone 225-686-3100  
Fax 225-686-7189

<http://www.ligo.caltech.edu/>

email: [quality@ligo.caltech.edu](mailto:quality@ligo.caltech.edu)

## Contents

<b>1. Scope</b>	<b>3</b>
<b>2. Supplier Quality System</b>	<b>3</b>
<b>2.1. Certified or Compliant</b>	<b>3</b>
<b>2.2. Calibration Program</b>	<b>3</b>
<b>3. Procurement Process</b>	<b>3</b>
<b>3.1. Pre-RFP/RFQ Supplier Visit</b>	<b>3</b>
<b>3.2. LIGO Procurement Documentation</b>	<b>3</b>
<b>3.3. Pre-Award Inspection</b>	<b>3</b>
<b>4. Manufacture, Assembly, and Inspection Requirements</b>	<b>4</b>
<b>4.1. Manufacturing Planning / Traveler</b>	<b>4</b>
<b>4.2. First Article Inspection</b>	<b>4</b>
<b>4.3. In-Process Inspection</b>	<b>4</b>
<b>4.4. Final Inspection</b>	<b>4</b>
<b>4.5. Source Inspection</b>	<b>4</b>
<b>4.6. Discrepant Material</b>	<b>4</b>
<b>4.7. Drawing and Specification Change Control</b>	<b>5</b>
<b>4.8. Welding Certifications</b>	<b>5</b>
<b>4.9. End Item Data Package</b>	<b>5</b>



## 1. Scope

This document is intended for Suppliers and potential Suppliers to LIGO when specified on the Statement of Work (SOW). Supplier requirements are defined, including: the Supplier's Quality System; inspection, material handling, packaging and shipping procedures.

## 2. Supplier Quality System

### 2.1. Certified or Compliant

During the Request for Proposal (RFP) or Request for Quote (RFQ) process, preference will be given to potential and current suppliers who are currently ISO 9001, AS9100, or TS16949 certified. LIGO can still contract with suppliers who are not certified but those suppliers typically have ISO 9001 compliant Quality Systems. Potential suppliers having neither an ISO 9001 certified nor compliant Quality System will be required to create a quality document addressing the main points of ISO 9001 with respect to the LIGO work. Only potential suppliers lacking certification shall submit a copy of their Quality System along with the bid package for consideration.

### 2.2. Calibration Program

The supplier shall maintain an ISO 9001 compliant calibration program of all instruments and tools required for the inspection of all LIGO production parts and assemblies manufactured by the supplier or sub-contractor.

## 3. Procurement Process

### 3.1. Pre-RFP/RFQ Supplier Visit

A LIGO representative may conduct a visit or audit to gage a potential supplier's Quality System, facilities, equipment and personnel capabilities, and capacity. The LIGO representative can explain any LIGO specific requirements that are not clear.

### 3.2. LIGO Procurement Documentation

LIGO will provide the supplier with the following documentation in support of the bid process (if applicable):

- 3.2.1. Statement of Work (SOW)
- 3.2.2. Technical documents, drawings, and specifications, identified by revision. Solid Models are available on request.
- 3.2.3. On-line access to all applicable LIGO specifications

### 3.3. Pre-Award Inspection

Prior to contract award LIGO staff may perform an audit of the prospective supplier's Quality System. The audit scope includes but is not limited to:

- Understanding of the various LIGO requirements and specifications. This should be an opportunity for both parties to communicate.
- Supplier QA/QC program and how it will be implemented for Advanced LIGO contracts.
- Manufacturing methodologies, especially as regards cleanliness and use of approved materials and fluids.
- Cleaning and packaging methodologies compared to RFP/RFQ requirements.
- Critical worker certification levels (i.e., welding, electrical, CNC, etc.).

- Calibration program review.

## 4. Manufacture, Assembly, and Inspection Requirements

### 4.1. Manufacturing Planning / Traveler

Unless otherwise instructed, the supplier shall create planning for each manufacturing job which identifies the following components. This planning shall be available for review by LIGO before, during, or after manufacturing.

- The schedule of operations, including the type of process to be performed (ie, mill, lathe, deburr, outside processing, etc.)
- Machinist sign-off and date, including quantity conforming and non-conforming
- Identification and definition of the inspection points during the manufacturing process
- Inspector sign-off and date, including quantity conforming and non-conforming
- Identification of process specifications, as applicable, for internal and external processes
- Identification of operational constraints, as appropriate (ie, no abrasive metal removal techniques for parts destined for Ultra High Vacuum use.)

### 4.2. First Article Inspection

LIGO may wish to witness or inspect the First Article part before the rest of the order is completed. The requirement for this will be defined on the Statement of Work if applicable.

### 4.3. In-Process Inspection

In-process inspections shall be performed where subsequent assembly stages will prevent/limit inspection access, and to detect defects early in the process. In-process inspections shall be identified in the manufacturing planning (see Section 4.1 above).

### 4.4. Final Inspection

The Supplier shall conduct a Final Inspection of all component parts and assemblies to verify completion and conformance of the following items:

- Conformance to all applicable drawings, SOW, and specifications.
- End Item Data Package review (refer to SOW for complete list)
- LIGO property control documentation, when LIGO materials are in possession of a supplier.
- Evidence of safety requirements compliance, if applicable.
- Shipping documentation such as the manifest or shipper.
- Verification of the adequacy of the shipment packaging and weather protection.
- Verification that transportation environmental controls and monitoring requirements will be satisfied.

### 4.5. Source Inspection

Source inspection by LIGO personnel may be required. The supplier will be notified of this in advance of shipping the components.

### 4.6. Discrepant Material

Discrepant parts must be identified and segregated immediately upon detection. If the discrepant parts are required to complete an order and the parts can be reworked to comply with the drawing and/or specifications and with no effect on the delivery date

then LIGO does not need to be notified. If the parts can be reworked to comply with the drawing and/or specifications but the rework process will adversely affect the delivery date, then the LIGO Contracting Officer must be notified.

Please immediately contact LIGO to discuss discrepant parts that cannot be reworked to comply with the drawing and/or specification. Suppliers should use the LIGO form [Q110001 Request for Deviation](#) to formalize a request to submit or rework discrepant parts which will not comply to the drawing and/or specifications. Email the completed form to [quality@ligo.caltech.edu](mailto:quality@ligo.caltech.edu) for a disposition.

The supplier must retain records of any rework processes as part of the job traveler package.

#### **4.7. Drawing and Specification Change Control**

All drawings and specifications will be controlled by the suppliers Quality Assurance Department, including receipt and distribution. Upon receiving the order/contract, all drawings will be verified as to correct number and revision.

Controlled documents must be kept updated at every document change or engineering change. The contract administrator under the guidance of QA will insure that all controlled documents, whether in house or out, will be updated.

Occasionally, LIGO may need to revise drawings for design or manufacturing reasons after the purchase order has been issued. These changes are normally discussed with the supplier in advance of official notification to come to a common agreement on the feasibility and implications of the desired changes. When the change will have no adverse effect on the cost or delivery of the part(s) then a Technical Directive Memorandum will be issued by LIGO to formally document the change. If the change is estimated to affect either cost or delivery of the part(s), then a Change Request will be initiated and sent to the supplier, followed by a revised Purchase Order.

Upon receipt of drawing and specification changes, the supplier Quality Assurance or other appropriate personnel will remove obsolete drawing and/or specifications and issue the latest drawing and/or specification to proper personnel. Obsolete drawings shall either be marked "obsolete" if needed for records or destroyed.

#### **4.8. Welding Certifications**

Suppliers of parts or assemblies requiring welding which will be used in an Ultra High Vacuum environment must refer to LIGO specification [E0900048 Welding Specification for Weldments used within the Advanced LIGO Vacuum System](#). This specification details numerous welding specific requirements. The SOW will state if this specification is invoked for a certain part or order.

#### **4.9. End Item Data Package**

The end item data package is the set of required documents to be supplied to LIGO upon delivery of ordered parts or services. Refer to the Statement of Work (SOW) for the complete list of documents to be included.



## **LASER INTERFEROMETER GRAVITATIONAL WAVE OBSERVATORY (LIGO)**

### **COMMERCIAL ITEMS OR SERVICES CONTRACT**

#### **GENERAL PROVISIONS CALIFORNIA INSTITUTE OF TECHNOLOGY "INSTITUTE"**

##### GENERAL PROVISION TITLE

1. Offer and Contract
2. Time of Delivery
3. Improper Delivery
4. Assignment
5. Authority of Institute Representative and Required Notices
6. Changes
7. Force Majeure
8. Existing Commercial Computer Software – Licensing
9. Export Licenses
10. Disputes and Governing Law
11. Inspection and Acceptance
12. Insurance
13. Indemnification
14. New Material
15. Order of Precedence
16. Payment
17. Use of Name
18. Title and Risk of Loss
19. Government Title to Property Purchased or Fabricated with Contract Funds
20. Taxes
21. Termination
22. Warranty
23. Audit and Records
24. Site Visits
25. Nondiscrimination
26. Equal Employment Opportunity
27. Anti-Kickback
28. Clean Air Act and the Federal Water Pollution Contract Act
29. Debarment and Suspension
30. Byrd Anti-Lobbying Amendment
31. Copeland "Anti-Kickback" Act
32. Davis Bacon Act
33. Surety Bonds
34. Rights to Inventions – 37 CFR part 401
35. Patent Rights - Bayh-Dole Act [35 U.S.C. 200 et seq.]

(See Page 2 for Individual General Provision Applicability)

## APPLICABILITY OF INDIVIDUAL GENERAL PROVISIONS

### APPLICABLE TO ALL TRANSACTIONS IN THE UNITED STATES

The term *United States* includes the several States of the United States, the District of Columbia, the Commonwealth of Puerto Rico, the Virgin Islands, American Samoa, Guam, Wake Island, the Canal Zone, and all other territories and possessions of the United States, and the term *States* includes any one of the forgoing.

- |  |   |
|--|---|
| 1. Offer and Contract  | 16. Payment   |
| 2. Time of Delivery  | 17. Use of Name   |
| 3. Improper Delivery   | 18. Title and Risk of Loss  |
| 4. Assignment  | 19. Government Title to Property Purchased or Fabricated with Contact Funds |
| 5. Authority of Institute Representatives and Required Notices | 20. Taxes   |
| 6. Changes   | 21. Termination   |
| 7. Force Majeure   | 22. Warranty  |
| 8. Existing Commercial Computer Software – Licensing           | 23. Audit and Records   |
| 10. Disputes and Governing Law                                 | 24. Site Visits   |
| 11. Inspection and Acceptance                                  | 25. Nondiscrimination   |
| 13. Indemnification  | 26. Equal Employment Opportunity  |
| 14. New Material   | 28. Clean Air Act and the Federal Water Pollution Control Act               |
| 15. Order of Precedence  |   |

### TAXES

20. The applicability of State sales tax is addressed on the face of the Purchase Order  
**[For imports]** Value Added Tax (VAT) is addressed on the face of the Purchase Order

### APPLICABLE IN SPECIAL CIRCUMSTANCES ACCORDING TO THEIR TERMS

9. **[For exports]** Compliance with Export Regulations  
12. **[Suppliers Working on Site]** Insurance  
27. **[For Contracts in excess of \$100,000]** Anti-Kickback Enforcement Act of 1986  
29. **[For Contracts in excess of \$25,000]** Debarment and Suspension  
30. **[For Contracts of \$100,000 or More]** Byrd Anti-Lobbying Amendment  
31. **[For designated Construction/Repair Contracts in excess of \$2,000]** Copeland “Anti-Kickback” Act  
32. **[For designated Construction/Repair Contracts in excess of \$2,000]** Davis-Bacon Act  
33. **[For designated Construction/Repair Contracts in excess of \$500,000]** Surety Bonds  
34. **[For designated Experimental, Development or Research Work]** Rights to Inventions- 37 CFR part 401  
35. **[For designated Experimental, Development or Research Work]** Patent Rights - Bayh-Dole Act [35 U.S.C. 200 et seq.]

### APPLICABLE TO ALL TRANSACTIONS IN THE UNITED STATES

These provisions **do not apply to foreign suppliers** performing outside the United States.

- |                                  |   |
|----------------------------------|---|
| 25. Nondiscrimination            | 32. Clean Air Act and the Federal Water Pollution Control Act |
| 27. Equal Employment Opportunity |   |

This agreement is a subcontract pursuant to an NSF Cooperative Agreement (CA) between the NSF and the Institute, [PHY-0328418](#).

1. **OFFER AND CONTRACT** The following terms, together with such terms, plans, specifications or other documents as attached or incorporated by reference as set forth on the face of this purchase order, constitute the offer of the Institute to Supplier and shall, when accepted, constitute the entire agreement ("Contract") between the Institute and Supplier. Institute hereby gives notice of its objection to any different or additional terms. This Contract is valid only as written. If price, terms, shipping date or other expressed condition of this Contract are not acceptable, the Institute must be notified and any variation must be accepted in writing prior to shipment or delivery. This Contract shall be deemed to have been accepted (a) in the absence of written notification of non-acceptance by the Supplier within a reasonable time, or (b) upon timely delivery of the products identified to the shipping address specified on the face of the order.
2. **TIME OF DELIVERY** Time is of the essence in this Contract. If delivery dates cannot be met, Supplier must notify the Institute immediately. Such notification shall not, however, constitute a change to the terms of this Contract except as the order may be modified in writing by the Institute.
3. **IMPROPER DELIVERY** In addition to other remedies provided by law, the Institute reserves the right to refuse any goods or services and to cancel all or any part of this Contract if Supplier fails to deliver all or any part of the goods or services in accordance with the terms and conditions of this Contract. Acceptance of any part of this order shall not bind the Institute to accept any future shipments nor deprive it of the right to return goods already accepted.
4. **ASSIGNMENT** The Supplier shall have no right to assign this Contract or any benefits from this Contract without prior written consent of the Institute.
5. **AUTHORITY OF INSTITUTE REPRESENTATIVES AND REQUIRED NOTICES; FACSIMILE AND ELECTRONIC SIGNATURES ACCEPTABLE**
  - (a) No order, notice, or direction received by the Supplier and issued pursuant to this Contract shall be binding upon either the Supplier or the Institute, unless issued or ratified in writing by the Institute Purchasing Agent, the Director of Procurement Services, or by representatives designated in writing by either of them.
  - (b) The parties agree that facsimile (fax) or electronic signature copies of contract documents are just as binding as originally-executed documents.
6. **CHANGES** The Institute may at any time, by a written order to the Supplier, make changes within

the general scope of this Contract in any one or more of the following: (a) drawings, designs, or specifications; (b) method of shipment or packing; and (c) time or place of delivery. If any such change causes an increase or decrease in the cost of, or the time required for, the performance of any part of the work under this order, an equitable adjustment may be made in the order price or delivery schedule or both, and the order shall be modified in writing accordingly. Any claim by Supplier for adjustment under this Article must be asserted within 30 days from the date of receipt by Supplier of the notification of change; provided, however, that the Institute, if it decides that the facts justify such action, may receive and act upon any such claim asserted at any time prior to final payment under this purchase order. Nothing in this clause shall excuse Supplier from proceeding with this order as changed.

7. **FORCE MAJEURE** Each party shall not be liable for damages arising out of either its failure to deliver or any delay in delivery caused by strikes, lockouts, fires, war, or acts of God. The Supplier shall notify the Institute in writing as soon as it is reasonably possible after the commencement of any event triggering a delayed delivery or inability to deliver.
8. **EXISTING COMMERCIAL COMPUTER SOFTWARE – LICENSING** (This Article is applicable to the acquisition of any existing commercial computer software under this Contract.)
  - a) Where the Supplier proposes its standard commercial software license, only those applicable portions that comply with the provisions of this Contract are incorporated into and made a part of this Contract.
  - (b) If the Supplier does not propose its standard commercial software license until after this Contract has been issued, or at or after the time the computer software is delivered, such license shall nevertheless be deemed incorporated into and made a part of this Contract under the same terms and conditions as in paragraph (a) above. For purposes of receiving updates, correction notices, consultation, and similar activities on the computer software, any authorized user may acknowledge receipt of a registration form or card and return it directly to the Supplier; however, such signing shall not add to or alter any of the terms and conditions of this Contract.
  - (c) If the specified computer software is shipped or delivered to the Institute, it shall be understood that the Supplier has unconditionally accepted the terms and conditions set forth in this Article, and that the terms and conditions of this Contract (including the incorporated license) constitute the entire agreement between the parties concerning rights in the computer software.
  - (d) Supplier understands and agrees that the computer software may be: (1)

Used, or copied for use, in or with any computer owned or leased by, or on behalf of the Institute provided that the software is not used, nor copied for use, in or with more than one computer simultaneously, unless otherwise permitted; (2) Reproduced for safekeeping (archives) or backup purposes; (3) Modified, adapted, or combined with other computer software, provided that the modified, combined, or adapted portions of the derivative software incorporating restricted computer software shall be subject to the same restricted rights; and (4) Disclosed and reproduced for use by Institute designees in accordance with this Article. (e) Supplier agrees that the software may be used by the Institute in support and furtherance of any of its obligations to the US Government or other funding organization. (f) Supplier warrants that it has the right to sell, license, or transfer the license for the software furnished to the Institute under this Contract in accordance with the terms of this Contract.

9. **EXPORT LICENSES** The Supplier shall comply with all U.S. export control laws and regulations, including the International Traffic in Arms Regulations (ITAR), 22 CFR Parts 120 through 130, and the Export Administration Regulations (EAR), 15 CFR Parts 730 through 799, in the performance of this Contract. In the absence of available license exemptions/exceptions, the Supplier shall be responsible for obtaining the appropriate licenses or other approvals, if required, for exports of hardware, technical data, and software, or for the provision of technical assistance.

10. **DISPUTES AND GOVERNING LAW** (a) Any dispute or claim arising out of, in connection with, or relating to this Contract shall be submitted for resolution to ascending levels of management of the parties. If the dispute cannot be resolved after such negotiations, either party may pursue any appropriate legal recourse not inconsistent with the provisions of this Contract. (b) Pending any decision, appeal or judgment or the settlement of any dispute, Supplier agrees to proceed diligently with the performance of the requirements of this Contract. (c) This Contract shall be construed and enforced in accordance with the laws of the State of California. Disputes will be adjudicated in Los Angeles, California.

11. **INSPECTION AND ACCEPTANCE** The Institute shall have the right to inspect the work and activities of the Supplier under this Contract in such manner and at all reasonable times as are deemed appropriate. Final inspection shall be at the Institute's premises unless otherwise agreed in writing. The Institute, at its option, may reject any non-conforming items and (i) return such non-conforming items to the Supplier at the Supplier's

risk and expense for credit to the Institute at the full invoice price plus all transportation and other related costs, or (ii) hold them for disposition in accordance with the Supplier's instructions at the Supplier's expense, including storage and handling. If the Institute rejects items as nonconforming, the quantities under this Contract will automatically be reduced unless the Institute otherwise notifies the Supplier. The Supplier will not replace quantities so reduced without written instruction by the Institute. Payment for nonconforming goods shall not constitute an acceptance thereof, limit, or impair the Institute's right to assert any legal or equitable remedy, or relieve the Supplier's responsibility for latent defects. The Institute may also opt for a refund of the amount paid under this Contract.

12. **INSURANCE** (This Article is applicable when the Supplier will be entering Institute-controlled premises.) (a) The Supplier shall, at its own expense, provide and maintain during the entire performance period of this Contract at least the following types and minimum amounts of insurance with the Institute named as an additional insured in policies for comprehensive liability insurance with a licensed carrier authorized to do business in the State of California: (1) Workers' Compensation and Employer's Liability Insurance, as required by applicable Federal and State workers' compensation and occupational disease statutes. The Employer's Liability coverage shall be at least \$100,000, except in states with exclusive or monopolistic funds that do not permit worker's compensation to be written by private carriers. (2) Comprehensive Liability Insurance, including automobiles (owned, non-owned, or leased), completed operations, products, and contractual liability, for a combined single limit of not less than \$1,000,000 for all deaths, injuries, and property damage arising from one accident or occurrence. (b) Insurance Certificates and Endorsements. Before commencing work under this Contract, the Supplier shall furnish (i) certificates of insurance for the coverages specified in paragraph (a) above, and (ii) an additional insured endorsement naming the Institute as an additional insured to the Contract for the coverage specified above. Such certificates and the endorsement shall provide that any cancellation or material change in the insurance policies shall not be effective (i) for such period as the laws of the State in which this Contract is to be performed, or (ii) until 30 days after the insurer or the Supplier gives written notice to the Institute, whichever period is longer. Also, such certificates and the endorsement shall (i) cover contractual liability assumed under this Contract, and (ii) be primary and noncontributing to any insurance procured by the Institute. The Supplier agrees to

permit the Institute to examine its original policies, should the Institute so request. Should the Supplier at any time neglect or refuse to provide the insurance required herein, or should such insurance be canceled, the Institute shall have the right to procure same and the costs thereof shall be deducted from monies then due or thereafter to become due to the Supplier.

13. **INDEMNIFICATION** The Supplier agrees to defend, indemnify and hold harmless the Institute from and against all claims, liability and expenses, including reasonable legal fees, arising from any actual or claimed: (i) injury to any person or property resulting from any act or omission of Supplier, its employees or agents, excepting such liability as may result solely from the negligent acts or omissions of the Institute or its employees; and (ii) infringement of any patent, copyright, or trademark by reason of the sale or use of the goods provided by Supplier hereunder. The Supplier's obligations hereunder shall survive acceptance of the goods and payment thereof by the Institute.
14. **NEW MATERIAL** Unless this Contract specifies otherwise, the Supplier represents that the supplies are new and are not of such age or so deteriorated as to impair their usefulness or safety. If the Supplier believes that furnishing other than new material will be in the Institute's interest, the Supplier shall so notify the Purchasing Agent in writing and request authority to use such material.
15. **ORDER OF PRECEDENCE** To the extent there is inconsistency among any documents relating to this order, the inconsistency will be resolved in the following order of priority: (a) These General Provisions; (b) The details specified on the order, or description of products or services; (c) any other documents the Institute agrees in writing to incorporate by reference.
16. **PAYMENT** (a) Invoices shall be submitted in duplicate to the attention of the Institute's Accounts Payable Department, unless otherwise specified, and shall contain the following information as applicable: (i) Contract number, (ii) item number, (iii) description of supplies or services, (iv) size, (v) quantity, (vi) unit price, (vii) extended totals and (viii) any other information which may be specified on the face of this Contract. Any applicable state sales or use taxes or Federal excise taxes shall be shown separately on the invoice. (b) The Institute shall pay the Supplier, upon the submission of proper invoices, the prices stipulated in this Contract for supplies delivered and accepted or services rendered and accepted, less any deductions provided in this Contract. (c) The Institute shall make its best effort to make payments within the net period, if any, specified in the Contract, measured from the date of receipt of

the goods or services at the destination or the date of receipt of the invoice, whichever is later. Discount time periods will be measured from the same date. Payment shall be deemed to have been made on the date the check is mailed or on the date on which an electronic funds transfer was made. In no event will the Institute be liable for or pay a surcharge, interest, or any kind of penalty as a result of the Institute's payment not being made within the net period, if any, specified in the Contract or the date of payment by electronic funds transfer. (d) Payment for goods or services in accordance with this paragraph will not waive or otherwise affect the right of the Institute to inspect such goods or services or to reject, or revoke acceptance of, nonconforming goods.

17. **USE OF NAME** Supplier agrees not to use the name or trademarks of the Institute or any member its staff in sales promotional work or advertising, or in any form of publicity, without the prior written permission of the Institute.
18. **TITLE AND RISK OF LOSS** (a) Unless otherwise provided in Section 19 or elsewhere in this Contract, title to tangible property (property of any kind except intangible property and debt instruments) furnished under this Contract shall pass to the Institute upon formal acceptance by the Institute, regardless of when or where the Institute takes physical possession, unless the Contract specifically provides for earlier passage of title. (b) Risk of loss shall not pass to the Institute until the tangible property called for in this Contract has been actually received and accepted by the Institute at the destination specified. Supplier assumes all responsibility for packing, crating, marking, transportation and liability for loss or damage in transit, notwithstanding any agreement by Institute to pay freight, express or other transportation charges. Supplier agrees to trace lost or delayed shipments at the request of the Institute.
19. **GOVERNMENT TITLE TO PROPERTY PURCHASED OR FABRICATED WITH CONTRACT FUNDS** Title to tangible property shall vest in the Government upon acquisition when the tangible property is intended to be installed at, incorporated into, built, or necessary for the construction or operation of either the Hanford or Livingston Observatories. All Government property acquired in accordance with this Section 19 shall be subject to the requirements set forth below:
  1. Title.
    - (a) Tangible Property means property of any kind except intangible property and debt instruments. Title to all tangible property procured with funds provided through this Contract, and subject to this Section 19, shall vest in the Government as follows:



1) If this Contract contains a provision directing the Supplier to purchase material which the Government will reimburse as a direct item of cost under the Institute's primary Award, title to property shall pass to and vest in the Government upon delivery of such property to the Government, to the Institute, to the Supplier, to any subcontractor, or to any agent of the Government, of the Supplier, or of any subcontractor; and

2) Title to all other property shall pass to and vest in the Government upon the earliest to occur of the following:

(i) issuance of the property for use in contract performance pursuant to this Contract;

(ii) commencement of processing of the property or its use in contract performance pursuant to this Contract; or

(iii) reimbursement of the cost of the property by the Institute on behalf of the Government.

2. Legal title to all tangible property furnished by the NSF or acquired from other Government agencies shall remain with the Government, unless otherwise specified in this Contract.

3. Title to Government property shall not be affected by the incorporation or attachment thereof to any property not owned by the Government, nor shall any Government property lose its identity by reason of affixation to any reality.

4. All subcontracts issued or awarded with respect to the performance of this Contract shall include provisions regarding the determination of title to tangible property acquired by the subcontractor in accordance with Sections 18 and 19.

5. Should Supplier purchase tangible property pursuant to this Contract and subject to this Section 19, Supplier shall be a limited agent of the NSF solely for the purpose of transferring and vesting title to such tangible property in the Federal Government. The agent shall be solely responsible for the payment of the purchase price of tangible property acquired, and the agent shall have no authority to bind or obligate the Institute, NSF or the Federal Government for payment of the purchase price to any third party. Such agents shall be and shall remain liable for the risk of loss of, destruction of, or damage to tangible property acquired until such tangible property is transferred to the possession of the Government or acceptance by the Institute.

20. **TAXES** (a) **Except as may be otherwise provided on this order**, the contract price includes all applicable Federal, State, and local taxes and duties. With respect to transactions for which the

Institute may be exempt from any tax or duty, the Institute will provide, upon request, evidence to support its claim to such exemption. (b) The Institute will comply with all Federal and State income tax laws with respect to withholding and year-end tax reporting. (c) The Internal Revenue Service (IRS) requires the Institute to have on file a Taxpayer Identification Number (TIN) for every US person or US business that receives a payment, regardless if the payment is tax reportable or not. This information is provided on IRS Form W-9. US Citizens and Resident Aliens are required to complete a Form W-9 before receiving any payments from the Institute. A TIN can be any of the following: a Social Security Number (SSN) an Individual Taxpayer Identification Number (ITIN) or an Employer Identification Number (EIN). Failure to provide a TIN will result in delay of payment and/or backup withholding. (d) Foreign businesses providing services in the US for the Institute are required to provide the appropriate IRS Form W-8 (i.e., Form W-8BEN, W-8ECI, or W-8IMY). (e) Foreign individuals providing services in the US for the Institute are required to provide an IRS Form W-8BEN or IRS Form 8233 depending on the appropriate tax withholding treatment.

21. **TERMINATION** (a) **For Cause.** The Institute may terminate this Contract, or any part of it, for cause in the event of any default by the Supplier, or if the Supplier fails to comply with any Contract terms and conditions, or fails to provide the Institute, upon request, with adequate assurances of future performance. In the event of termination for cause, the Institute shall not be liable to the Supplier for any amount for supplies or services not accepted, and the Supplier shall be liable to the Institute for any and all rights and remedies provided by law. If it is determined that the Institute improperly terminated this Contract for cause, such termination shall be deemed a termination for convenience. (b) **For Convenience.** The Institute reserves the right to terminate this Contract, or any part hereof, for its sole convenience. In the event of such termination, the Supplier shall immediately stop all work hereunder and shall immediately cause any and all of its subcontractors to cease work. Subject to the terms of this Contract, the Supplier shall be paid a percentage of the Contract price reflecting the percentage of the work performed prior to the notice of termination, plus reasonable charges the Supplier can demonstrate to the satisfaction of the Institute, using its standard record keeping system, have resulted from the termination. The Supplier shall not be paid for any work performed or costs incurred which reasonably could have been avoided.

22. **WARRANTY** Supplier expressly warrants all goods and services delivered under this Contract to be free from defects in material and workmanship and to be of the quality, size and dimensions ordered. This express warranty shall not be waived by reason of the acceptance of the goods or services or payment by Institute. The Supplier shall provide the Institute with a copy of any standard warranty which is normally offered on a commercial product deliverable under this Contract. The commercial product warranty shall be deemed to be incorporated by reference and the Institute shall be entitled to all rights under such warranty.
23. **AUDIT AND RECORDS** Financial records, supporting documents, statistical records, and other records pertinent to this Contract shall be retained by the Supplier for a period of five years from acceptance by the Institute. Supplier agrees that the Institute, the National Science Foundation, the Comptroller General of the United States, or any of their duly authorized representatives, shall have access to any books, documents, papers and records of the Supplier which are directly pertinent to this Contract, for the purpose of making audits, examinations, excerpts and transcriptions.
24. **SITE VISITS** NSF and the Institute, through authorized representatives, have the right, at all reasonable times, to make site visits to review project accomplishments and management control systems and to provide such technical assistance as may be required. If any site visit is made by NSF or the Institute on the premises of the Supplier or a contractor under a subcontract, the Supplier shall provide and shall require its contractors to provide all reasonable facilities and assistance for the safety and convenience of the Institute or Government representatives in the performance of their duties. All site visits and evaluations shall be performed in such a manner that will not unduly delay the work.
25. **NONDISCRIMINATION** The Contract is subject to the provisions of Title VI of the Civil Rights Act of 1964 [42 U.S.C. § 2000d], Title IX of the Education Amendments of 1972 [20 USC §§ 1681 et seq.], the Rehabilitation Act of 1973 [29 U.S.C. § 794], the Age Discrimination Act of 1975 [42 U.S.C. §§ 6101 et seq], and all regulations and policies issued by NSF pursuant to these statutes. In accordance with these statutes, regulations, and policies, no person on the basis of race, color, national origin, sex, disability, or age shall be excluded from participation in, be denied the benefits of, or otherwise be subjected to discrimination under the Contract.
26. **EQUAL EMPLOYMENT OPPORTUNITY** This Contract is subject to the requirements of Executive Orders 11246 and 11375 and the rules and regulations or the Secretary of Labor (41 CFR Chapter 60) in promoting Equal Employment Opportunities.
27. **ANTI-KICKBACK ENFORCEMENT ACT OF 1986** This Contract is subject to the provisions of the Anti-Kickback Enforcement Act of 1986, Public Law 99-634 (41 U.S.C. 51-58). By accepting this order, Seller certifies that it has not paid kickbacks directly or indirectly to any Institute employee for the purpose of obtaining this or any other Institute purchase order or to obtain favorable treatment in an Institute matter.
28. **CLEAN AIR ACT AND THE FEDERAL WATER POLLUTION CONTROL ACT** – Should this Contract be for an amount in excess of \$100,000, Supplier agrees to comply with all applicable standards, orders or regulations issued pursuant to the Clean Air Act (42 U.S.C. 7401 et seq.) and the Federal Water Pollution Control Act as amended (33 U.S.C. 1251 et seq.). Further, Supplier agrees as follows:
- To comply with all the requirements of Section 114 of the Clean Air Act [42 U.S.C. §7414] and Section 308 of the Clean Water Act [33 U.S.C. § 1318], respectively, relating to inspection, monitoring, entry, reports and information, as well as other requirements specified in Section 114 and Section 308 of the Clean Air Act and the Clean Water Act, respectively, and all regulations and guidelines issued thereunder before the Contract.
  - That no portion of the work required by the Contract will be performed in a facility listed on the Environmental Protection Agency List of Violating Facilities on the date that the Contract was awarded unless and until EPA eliminates the name of such facility or facilities from such listing.
  - To use its best efforts to comply with clean air standards and clean water standards at the facility in which the Contract is being performed.
  - To insert the substance of the provisions of this article into any nonexempt subcontract.
29. **DEBARMENT AND SUSPENSION** – (a) Supplier shall fully comply with the requirements stipulated in 2 CFR Part 180, as modified by 45 CFR 620.330 and shall ensure that any lower tier covered transaction, as described in 2 CFR 180.220 and modified by 45 CFR 620.200 and 620.220 includes a term or condition requiring compliance with these requirements. The Supplier acknowledges that failing to disclose the information required under 45 CFR § 620.335 may result in the termination of the Contract, or pursuance of other available remedies, including suspension and debarment. Supplier may access the Excluded Parties List System at <http://epls.arnet.gov>. (b) No contract at any tier shall be made to parties listed on the General Services Administration's List

of Parties Excluded from Federal Procurement or Nonprocurement Programs in accordance with E.O.s 12549 and 12689, "Debarment and Suspension." This list contains the names of parties debarred, suspended, or otherwise excluded by agencies, and contractors declared ineligible under statutory or regulatory authority other than E.O. 12549. Supplier, whose Contract exceeds the small purchase threshold, shall provide the required certification regarding its exclusion status and that of its principal employees.

30. **[FOR CONTRACTS OF \$100,000 OR MORE] BYRD ANTI-LOBBYING AMENDMENT** - Supplier warrants that Supplier has applied or bid on a Contract of \$100,000 or more and has filed the required certification. Each subcontracting tier must certify to the tier above that it will not and has not used Federal appropriated funds to pay any person or organization for influencing or attempting to influence an officer or employee of any agency, a member of Congress, officer or employee of Congress, or an employee of a member of Congress in connection with obtaining any Federal contract, grant or any other award covered by 31 U.S.C. 1352. Each tier shall also disclose any lobbying with non-Federal funds that takes place in connection with obtaining any Federal award. Such disclosures are forwarded from tier to tier up to the recipient.
31. **[FOR CONSTRUCTION/REPAIR CONTRACTS >\$2000] Copeland "Anti-Kickback" Act (18 U.S.C. 874 and 40 U.S.C. 276c)** Supplier shall comply with the Copeland "Anti-Kickback" Act (18 U.S.C. 874), as supplemented by Department of Labor regulations (29 CFR part 3, "Contractors and Subcontractors on Public Building or Public Work Financed in Whole or in Part by Loans or Grants from the United States").
32. **[FOR CONSTRUCTION/REPAIR CONTRACTS >\$2000] Davis-Bacon Act, as amended (40 U.S.C. 276a to a-7)** Supplier shall comply with the Davis-Bacon Act (40 U.S.C. 276a to a-7) and as supplemented by Department of Labor regulations (29 CFR part 5, "Labor Standards Provisions Applicable to Contracts Governing Federally Financed and Assisted Construction").
33. **[FOR CONSTRUCTION/REPAIR CONTRACTS >\$500,000] Surety Bonds - If so directed**, the Supplier shall furnish separate bid guarantees, performance and payment bonds to the Institute. Each bond shall set forth a penal sum in an amount not less than the Contract Price. Each bond furnished by the Supplier shall incorporate by reference the terms of this Contract as fully as though they were set forth verbatim in such bonds. In the event the Contract Price is adjusted by Change Order executed by the Contractor, the

penal sum of both the performance bond and the payment bond shall be deemed increased by like amount. The performance and payment bonds furnished by the Supplier shall be in form suitable to Institute and shall be executed by a surety, or sureties, reasonably acceptable to the Institute.

34. **[For designated Experimental, Development or Research Work] Rights to Inventions** - For non-profit organizations and small business firms, patent rights shall be governed by 37 CFR part 401, titled "Rights to Inventions Made by Non-Profit Organizations and Small Business Firms under Government Grants, Contracts and Cooperative Agreements".
35. **[For designated Experimental, Development or Research Work] Patent Rights** – Bayh-Dole Act [35 U.S.C. 200 et seq.]