

LIGO Laboratory / LIGO Scientific Collaboration

LIGO- E1300925-V1

LIGO

December 9th, 2013

aLIGO HEPI L1 HAM4 Assembly Validation Report

E1300925-V1

Adrien Le Roux for the SEI Team

Distribution of this document:
Advanced LIGO Project

This is an internal working note
of the LIGO Laboratory

California Institute of Technology
LIGO Project – MS 18-34
1200 E. California Blvd.
Pasadena, CA 91125
Phone (626) 395-2129
Fax (626) 304-9834
E-mail: info@ligo.caltech.edu

Massachusetts Institute of Technology
LIGO Project – NW22-295
185 Albany St
Cambridge, MA 02139
Phone (617) 253-4824
Fax (617) 253-7014
E-mail: info@ligo.mit.edu

LIGO Hanford Observatory
P.O. Box 1970
Mail Stop S9-02
Richland WA 99352
Phone 509-372-8106
Fax 509-372-8137

LIGO Livingston Observatory
P.O. Box 940
Livingston, LA 70754
Phone 225-686-3100
Fax 225-686-7189

Contents

Contents	2
Sub-Components Testing.....	4
Assembly Validation.....	7
1.1 Load Cells assembly	7
1.2 Bellows	8
1.3 Boot Location	8
1.4 Check Stops Gaps	11
1.5 Gaps check.....	13
1.6 IPS Centering.....	16
1.7 Sensor ASD	17
1.8 SUS-watchdogs interaction test.....	21
1.9 Static Test local drive	22
1.10 Linearity Test/Range of motion in the local basis	24
1.11 Actuator Plate to Shields gap.....	26
1.12 Valve Check.....	27
1.13 Local-to-local measurements	28
1.14 Alignment offsets:.....	31
Conclusion	32

Introduction

This document summarizes the different tests which have been done to validate HEPI L1 HAM4. All the HEPI testing reports must be posted under:

LIGO-E1300454: aLIGO HEPI Testing Reports

Sub-Components Testing

- Kaman Inductive Position Sensors: calibration, linearity, factory data, noise measurements (E0900426 – HEPI Kaman Sensor Receiving Analysis - Results posted in the SVN)

Note: these serial numbers have not been recorded at the time of install and are not hidden.

- HEPI actuator linearity test (E1100338 – aLIGO HEPI Actuators Test Results).

Note: these serial numbers have not been recorded at the time of install but are still accessible and will be recorded.

- L4C test (Q0900007)

	Horizontal	Vertical
Pier 1	L41684	L41629
Pier 2	L41663	L41611
Pier 3	L41675	L41630
Pier 4	L41653	L41637

Power spectrum

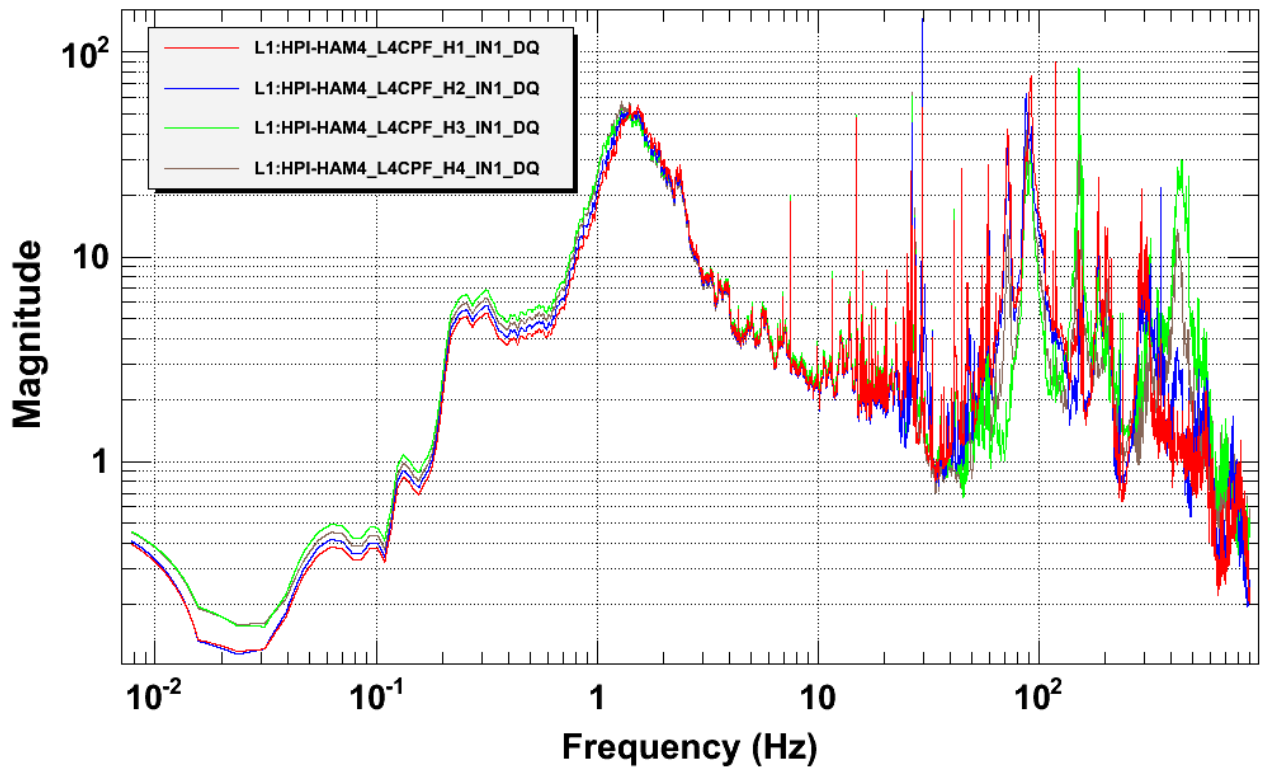

T0=20/07/2012 00:48:21

Avg=621/Bin=11L

BW=0.0117178

Figure 1: Power spectra of L1 HAM 4 horizontal L4Cs

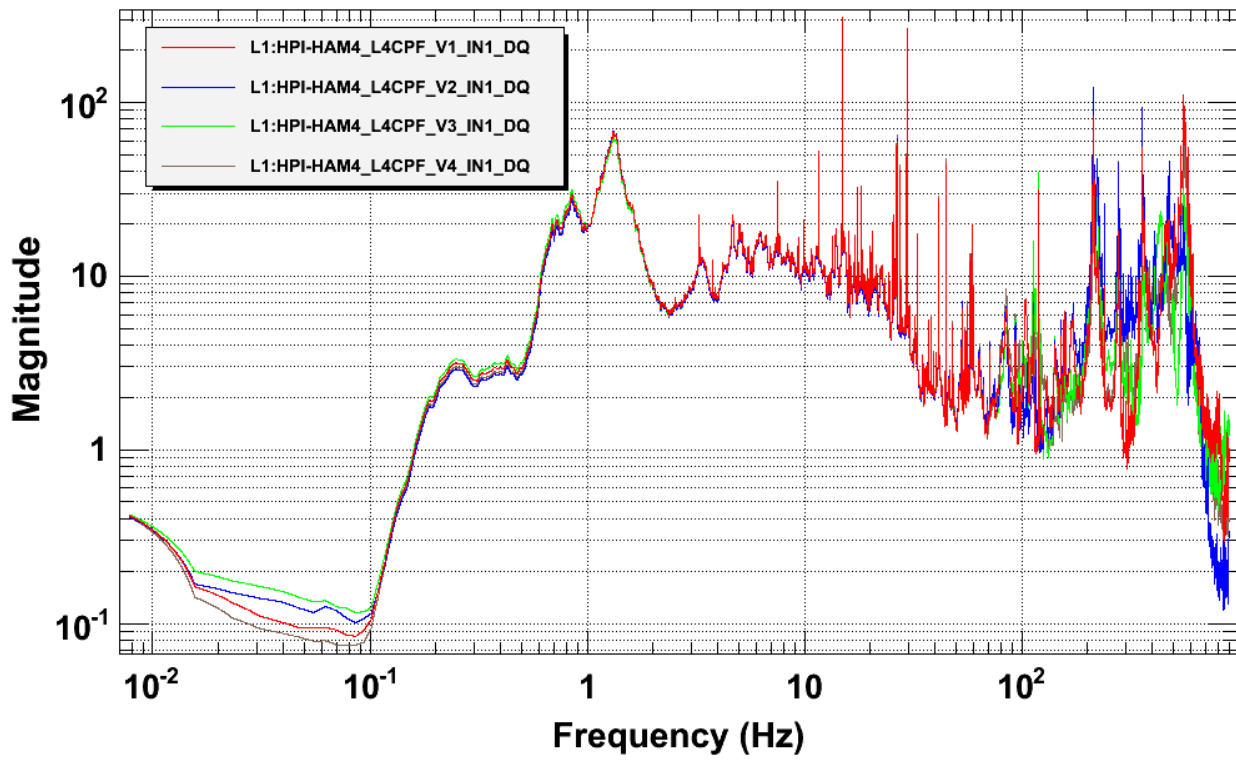
Power spectrum

T0=17/07/2012 23:56:49

Avg=500/Bin=11L

BW=0.0117178

Figure 2: Power spectra of L1 HAM 4 horizontal L4Cs

Assembly Validation

1.1 Load Cells assembly

- Spring attachment

For the HAM HEPI springs, check the assembly per [D1003359](#).

- Load cell values

HAM HEPI load cell capacity → 2000 lbs

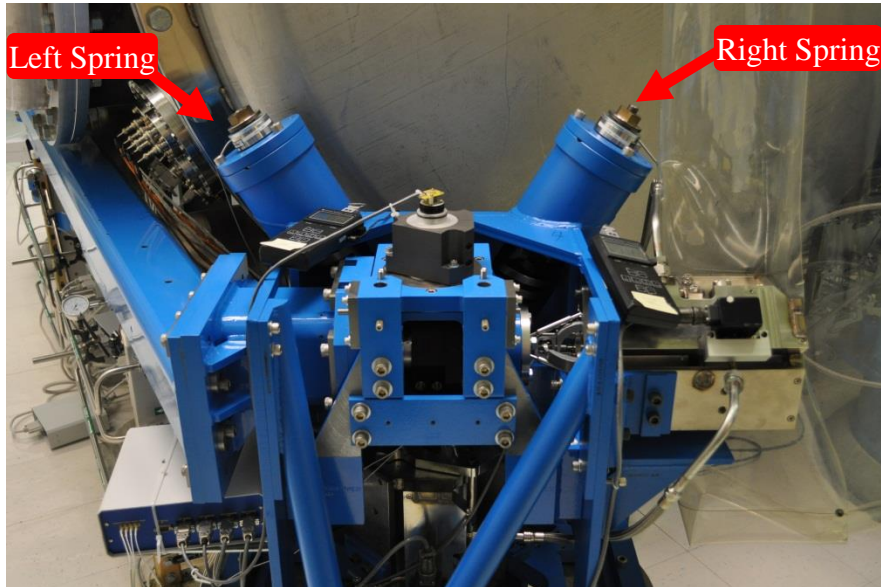

Figure 3: HAM-HEPI example at LASTI

	Left Spring (lbs)	Right Spring (lbs)
Pier 1		
Pier 2		
Pier 3		
Pier 4		

Acceptance criteria:

- The values must not exceed 80% of the load cell capacity (<1600lbs for HAM).

Test result:

Passed: ____

Failed: ____

Waived: ____

1.2 Bellows

The bellows are hard to access and tests are hard to proceed. After several discussions and brainstorming sessions, it has been decided not to measure the gaps on HEPI-HAM.

Test result: Passed: Failed: Waived: X

1.3 Boot Location

Tangential Left: 5.380”

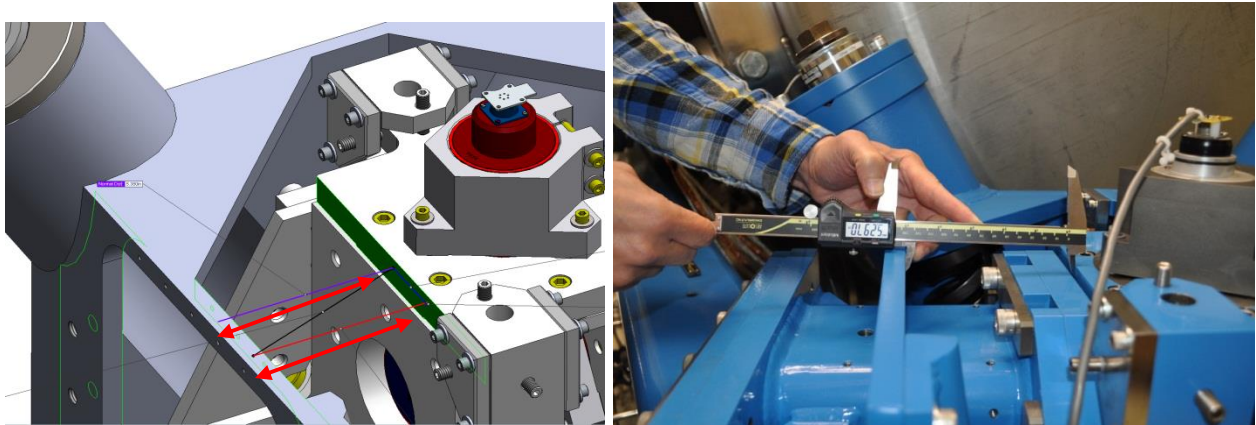

Figure 4: Boot location, tangential left gap measurement

Tangential Right: 5.380”

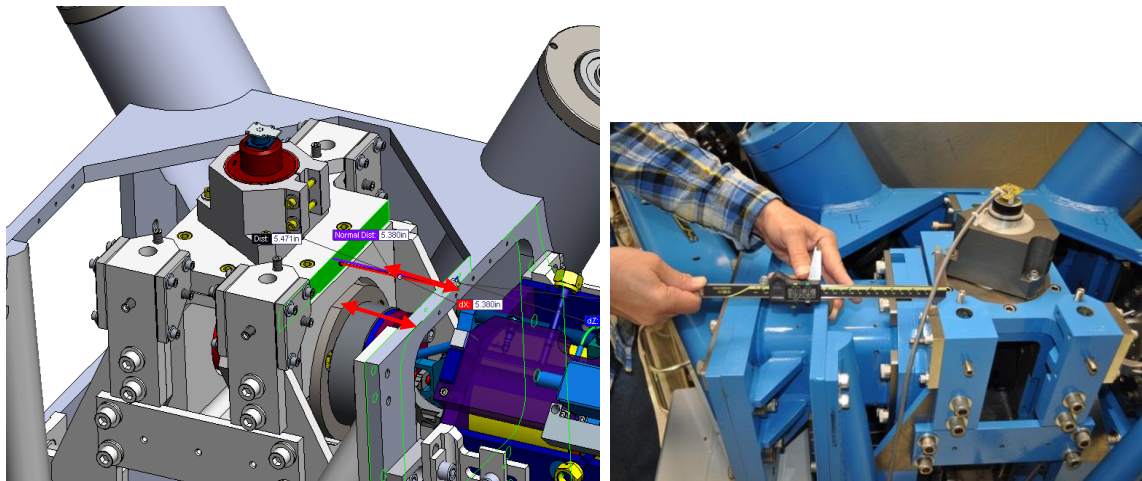

Figure 5: Boot location, tangential right gap measurement

Radial Back: 1.17"

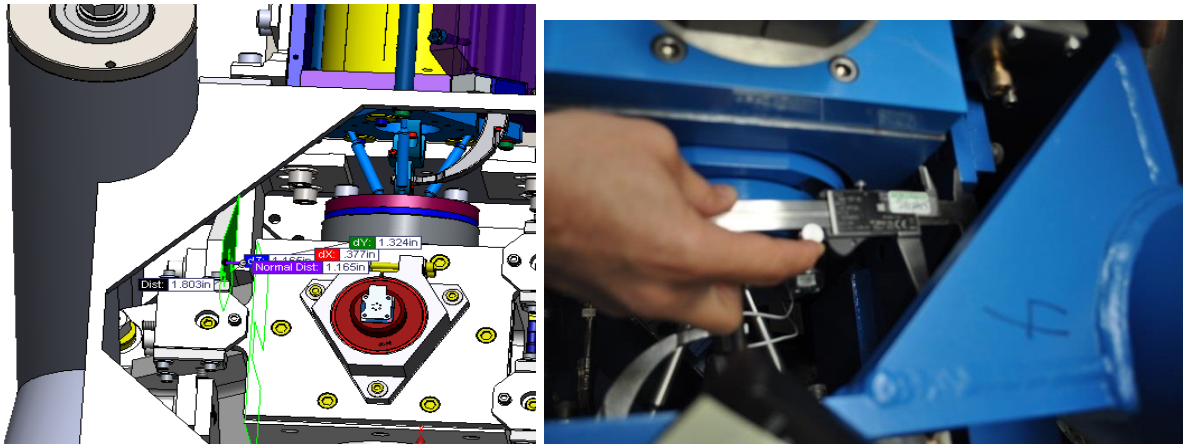

Figure 6: Boot location, radial back gap measurement

Radial Front: 1.42"

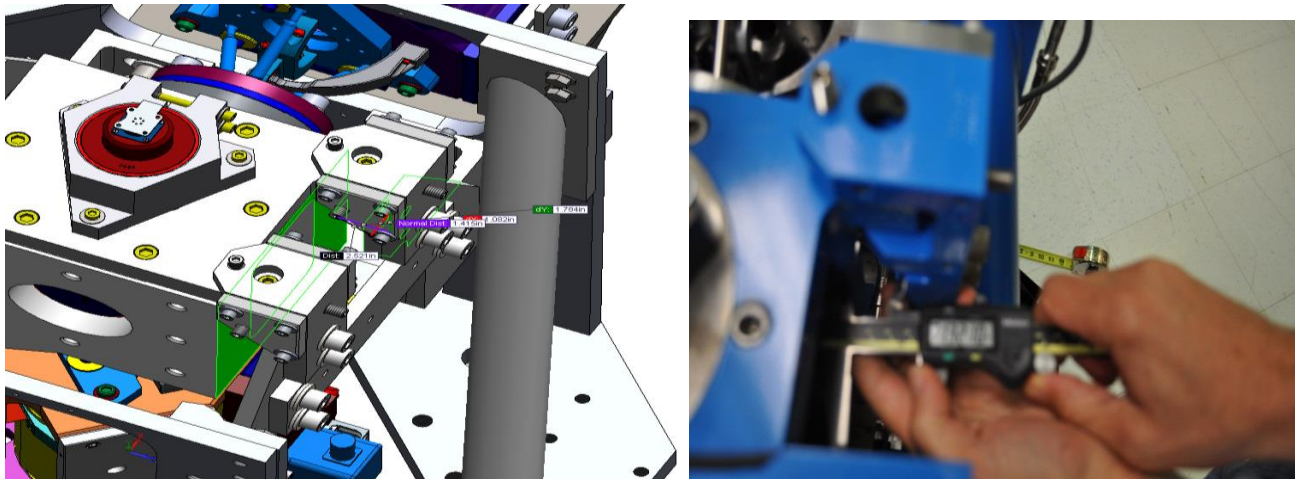

Figure 7: Boot location, radial front gap measurement

Vertical: 0.32"

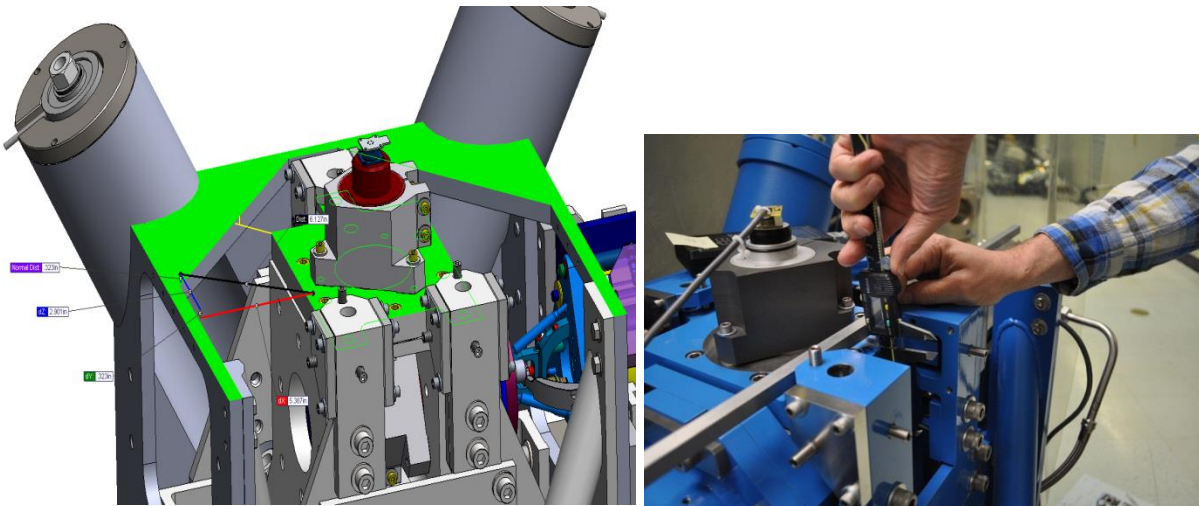

Figure 8: Boot location, vertical gap measurement

	Pier 1	Pier 2	Pier 3	Pier 4	Nominal
Tangential Left	5.061	5.021	4.884	5.215	5.38
Tangential Right	5.631	5.654	5.785	5.485	5.38
Radial Back	1.396	1.216	1.374	1.211	1.17
Radial Front	1.279	1.36	1.285	1.34	1.42
Vertical	0.366	0.2	0.233	0.419	0.32

Acceptance criteria:

	Pier 1	Pier 2	Pier 3	Pier 4	Requirements
Tangential Left	-0.319	-0.359	-0.496	-0.165	+/- 0.20
Tangential Right	0.251	0.274	0.405	0.105	+/- 0.20
Radial Back	0.226	0.046	0.204	0.041	+/- 0.10
Radial Front	-0.141	-0.06	-0.135	-0.08	+/- 0.15
Vertical	0.046	-0.12	-0.087	0.099	+/- 0.20

Note: usually this test can be waived if step 1.10 Linearity Test/Range of motion in the local basis passes because it means that the system has a full range of motion and is, therefore, free to move.

Test result: Passed: ___ Failed: X Waived: ___

1.4 Check Stops Gaps

The stops must not touch the boot. There are 15 stops per boot, 5 per F bracket.

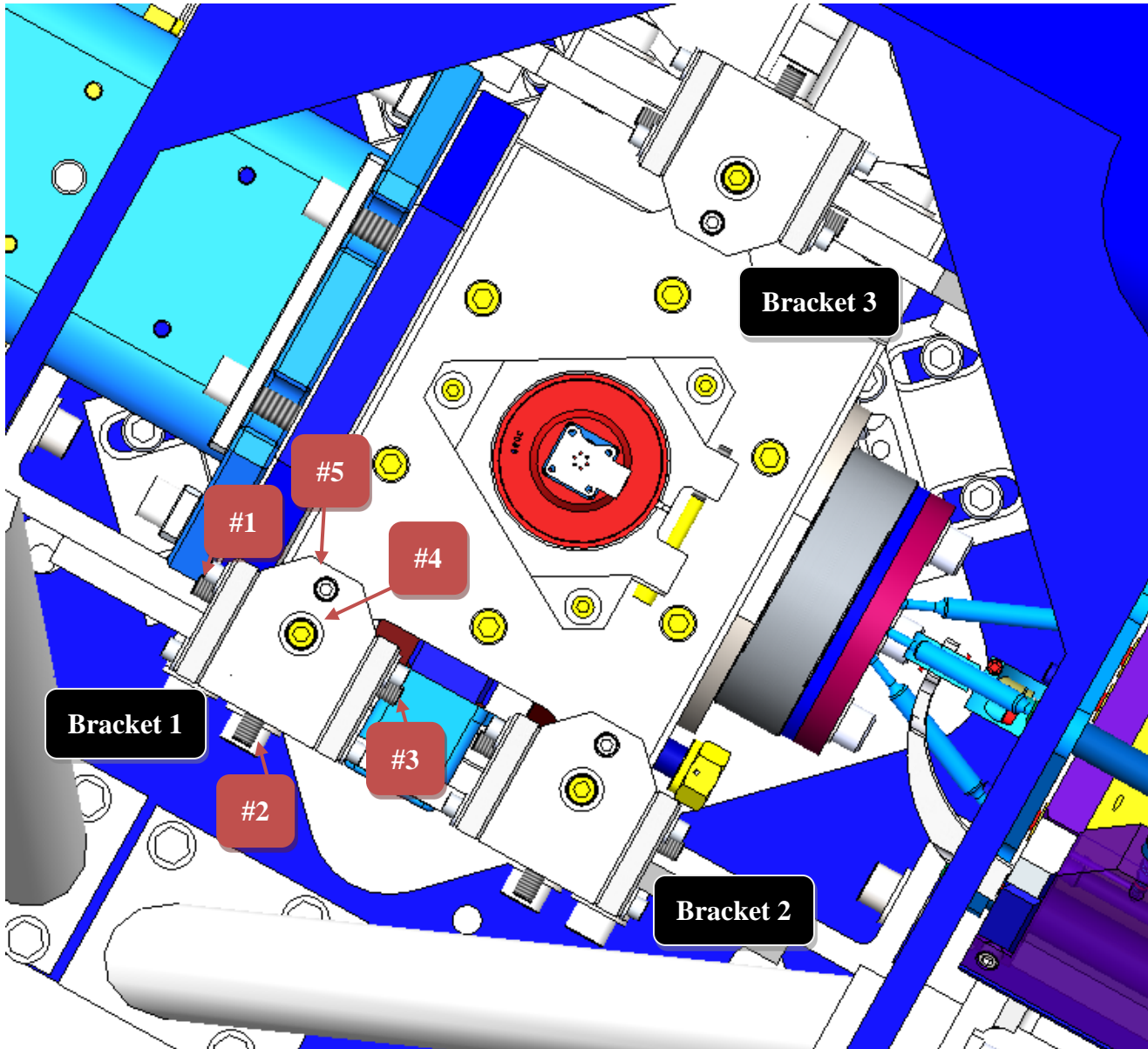

Figure 9: Locations of the boot's stops

Acceptance criteria:

- A 0.062" shim must fit into the gaps

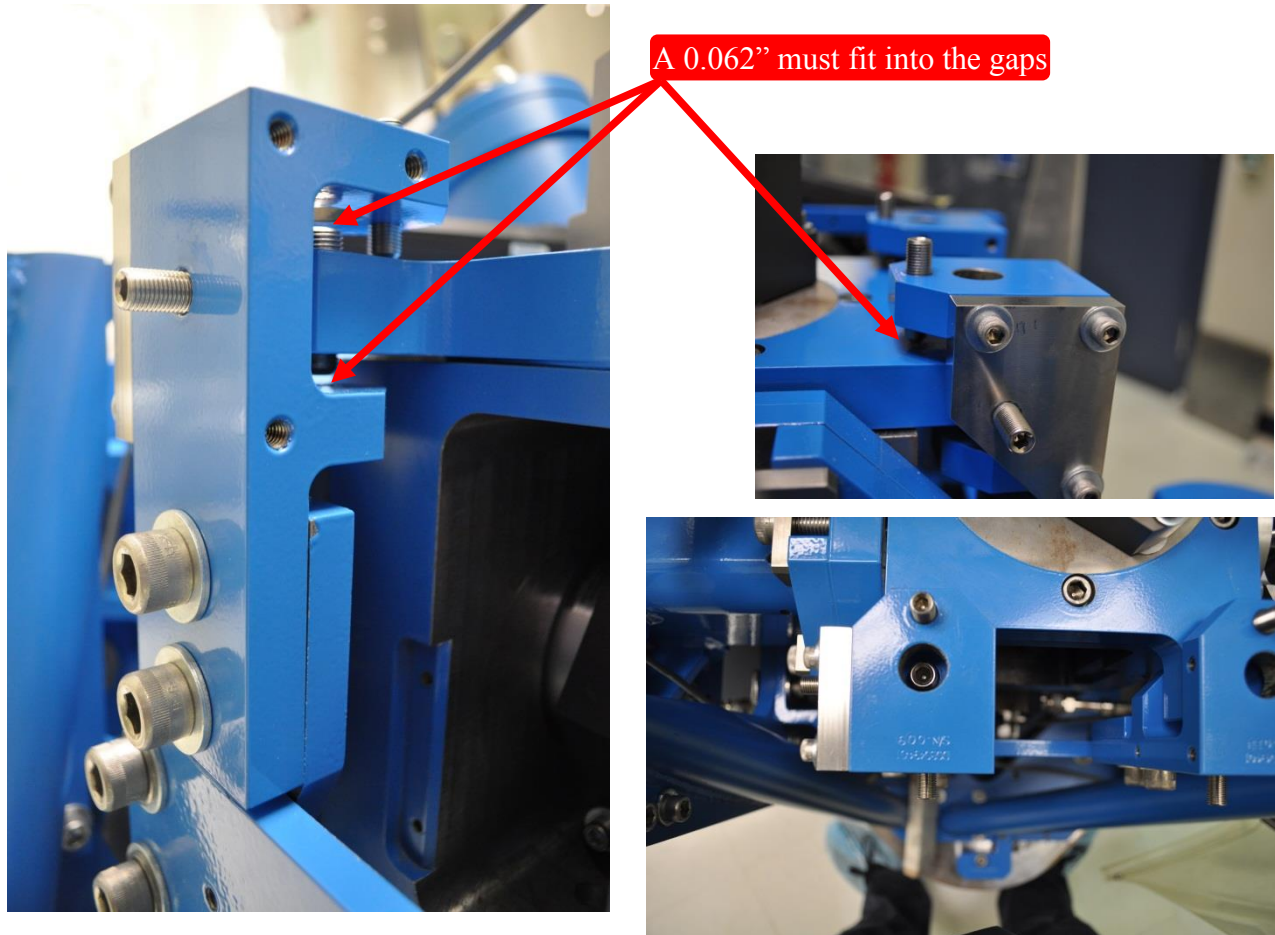

Figure 10: Locations of the boot's gaps to measure

	Bracket 1						Bracket 2						Bracket 3					
	Gap 1	Gap 2	Gap 3	Gap4 above	Gap4 under	Gap 5	Gap 1	Gap 2	Gap 3	Gap4 above	Gap4 under	Gap 5	Gap 1	Gap 2	Gap 3	Gap4 above	Gap4 under	Gap 5
Pier 1	Go	Go	Go	Go	Go	Go	Go	Go	Go	Go	Go	Go	Go	Go	Go	Go	Go	Go
Pier 2	Go	Go	Go	Go	Go	Go	Go	Go	Go	Go	Go	Go	Go	Go	Go	Go	Go	Go
Pier 3	Go	Go	Go	Go	Go	Go	Go	Go	Go	Go	Go	Go	Go	Go	Go	Go	Go	Go
Pier 4	Go	Go	Go	Go	Go	Go	Go	Go	Go	Go	Go	Go	Go	Go	Go	Go	Go	Go

Note: HAM 4 is currently in the locked position so the measurement of these gaps is pointless at this time. Measurements will be taken when HEPI will be unlocked on HAM 4.

Test result: Passed: ___ Failed: ___ Waived: ___

1.5 Gaps check

Four particular gaps need to be check.

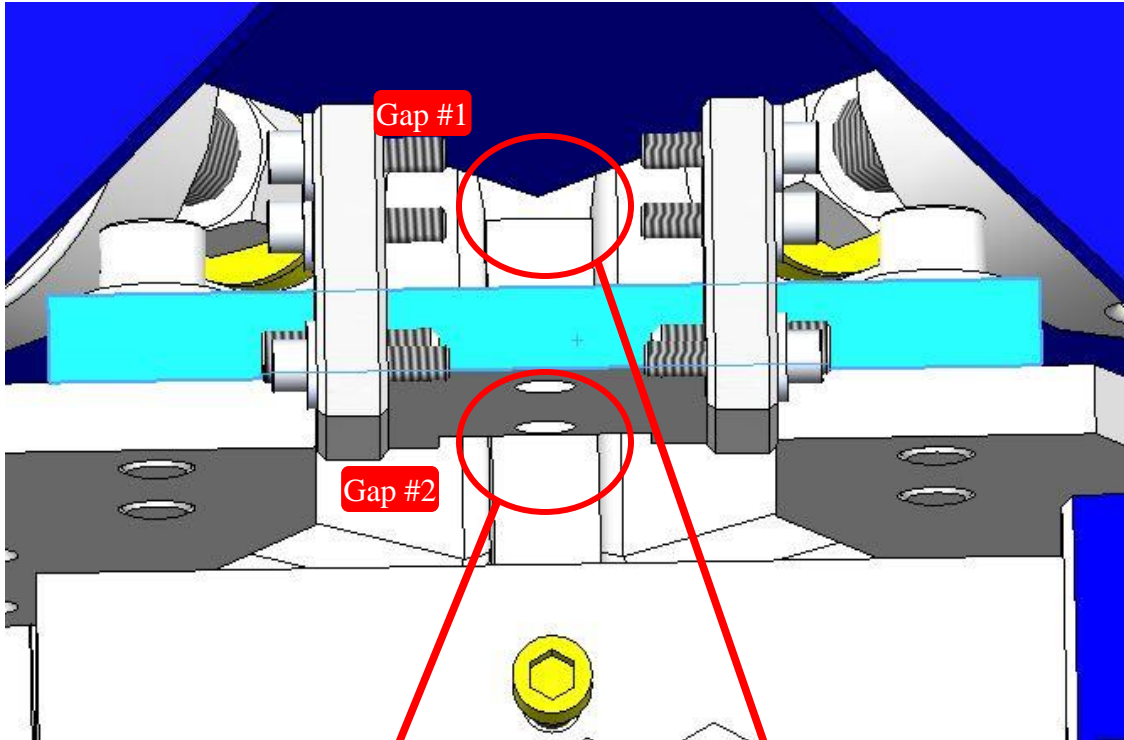

Note: The F bracket has been removed for a better visibility

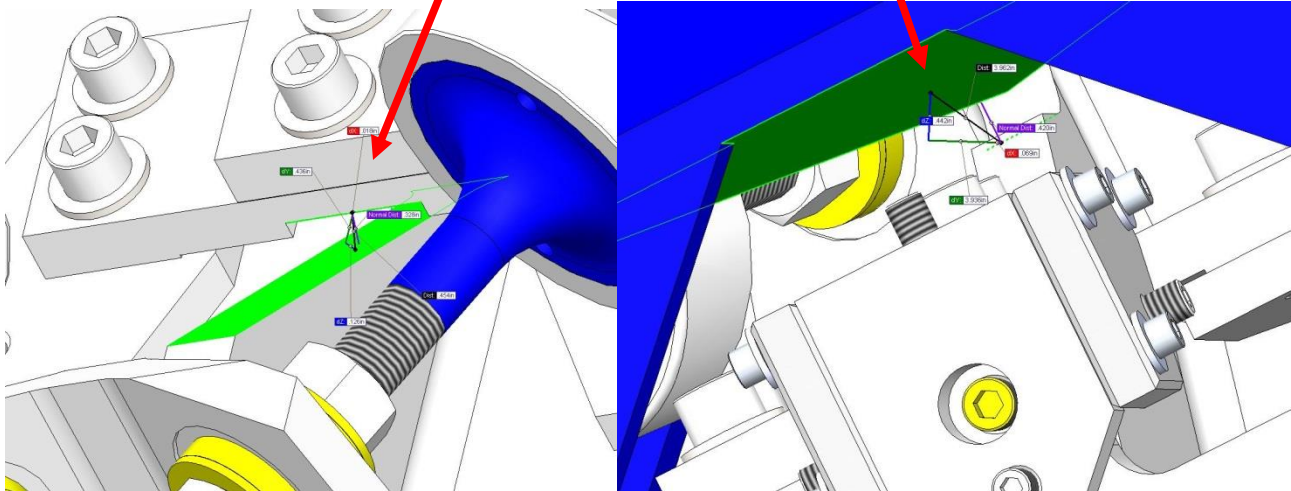

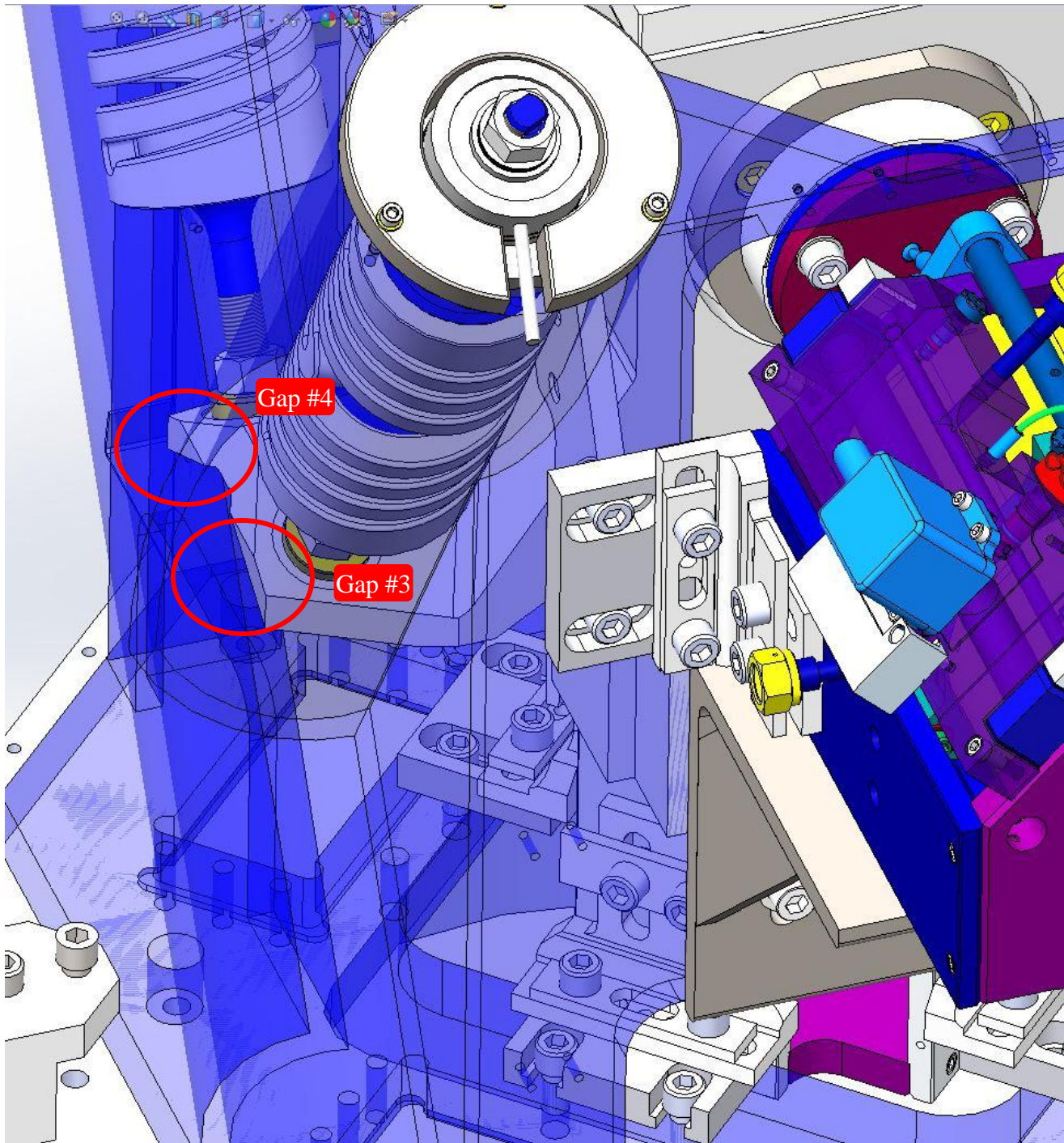

Figure 11: Gaps which need to be checked

Acceptance criteria:

- a 0.08" shim must fit in these two gaps

Issues/difficulties/comments regarding this test: Gap#1 is tricky to reach. At LASTI, the solution found was to tape the shim to an extension (rod, rigid ruler, etc.).

Gap#2 should be reachable by hand.

Gap#3 and 4 are tricky, but should also be doable (no picture)

Gap#1



Figure 12: First gap to measure (on the first picture, we can see the tool used to measure that gap)

Gap#2



Figure 13: Second gap to measure

	Gap#1	Gap#2	Gap#3	Gap#4
Pier 1	Go	Go	Go	Go
Pier 2	Go	Go	Go	Go
Pier 3	Go	Go	Go	Go
Pier 4	Go	Go	Go	Go

Note: usually this test can be waived if step 1.10 Linearity Test/Range of motion in the local basis passes because it means that the system has a full range of motion and is, therefore, free to move.

Test result: **Passed:** ____ **Failed:** ____ **Waived:** X

1.6 IPS Centering

Scripts files for processing and plotting in SVN at:

/SeiSVN/seismic/HEPI/Common/Testing_Functions_HEPI/Offset_STD_IPS_HEPI.m

Note: All the loops must be turned off during this test.

	H1	H2	H3	H4	V1	V2	V3	V4
Mean (counts)								
Acceptance	+/- 15000	+/- 15000	+/- 15000	+/- 15000	+/- 15000	+/- 15000	+/- 15000	+/- 15000

Test result: **Passed:** ____ **Failed:** ____ **Waived:** ____

1.7 Sensor ASD

Scripts files for processing and plotting in SVN at:

/SeiSVN/seismic/HEPI/Common/Testing_Functions_HEPI/ASD_Measurements_Local_HEPI.m

Data in SVN at:

SeiSVN/seismic/HEPI/L1/HAM4/Data/Perf_Analysis/2013-06-24-HEPI_Level1-ISI_Level2/

- *HEPI_L1_HAM4_Perf_Analysis_Parameters_2013-06-24-HEPI_Level1-ISI_Level2.mat*
- *HEPI_L1_HAM4_Test1_2013-06-24-HEPI_Level1-ISI_Level2.mat*
- *HEPI_L1_HAM4_Test2_2013-06-24-HEPI_Level1-ISI_Level2.mat*

Figures in SVN at:

/SeiSVN/seismic/HEPI/L1/HAM4/Data/Figures/Perf_Analysis/2013-06-24-HEPI_Level1-ISI_Level2/fig/

- *HEPI_L1_HAM4_Test_1_Fig_a_HPI_L4C_Hor_2013-06-24-HEPI_Level1-ISI_Level2.fig*
- *HEPI_L1_HAM4_Test_1_Fig_b_HPI_L4C_Vert_2013-06-24-HEPI_Level1-ISI_Level2.fig*
- *HEPI_L1_HAM4_Test_1_Fig_c_IPS_Hor_2013-06-24-HEPI_Level1-ISI_Level2.fig*
- *HEPI_L1_HAM4_Test_1_Fig_d_IPS_Vert_2013-06-24-HEPI_Level1-ISI_Level2.fig*

L1 HAM4-HEPI, Local Sensors Spectra: Horizontal L4C 2013-06-24-HEPI_{level1}-ISI_{level2}

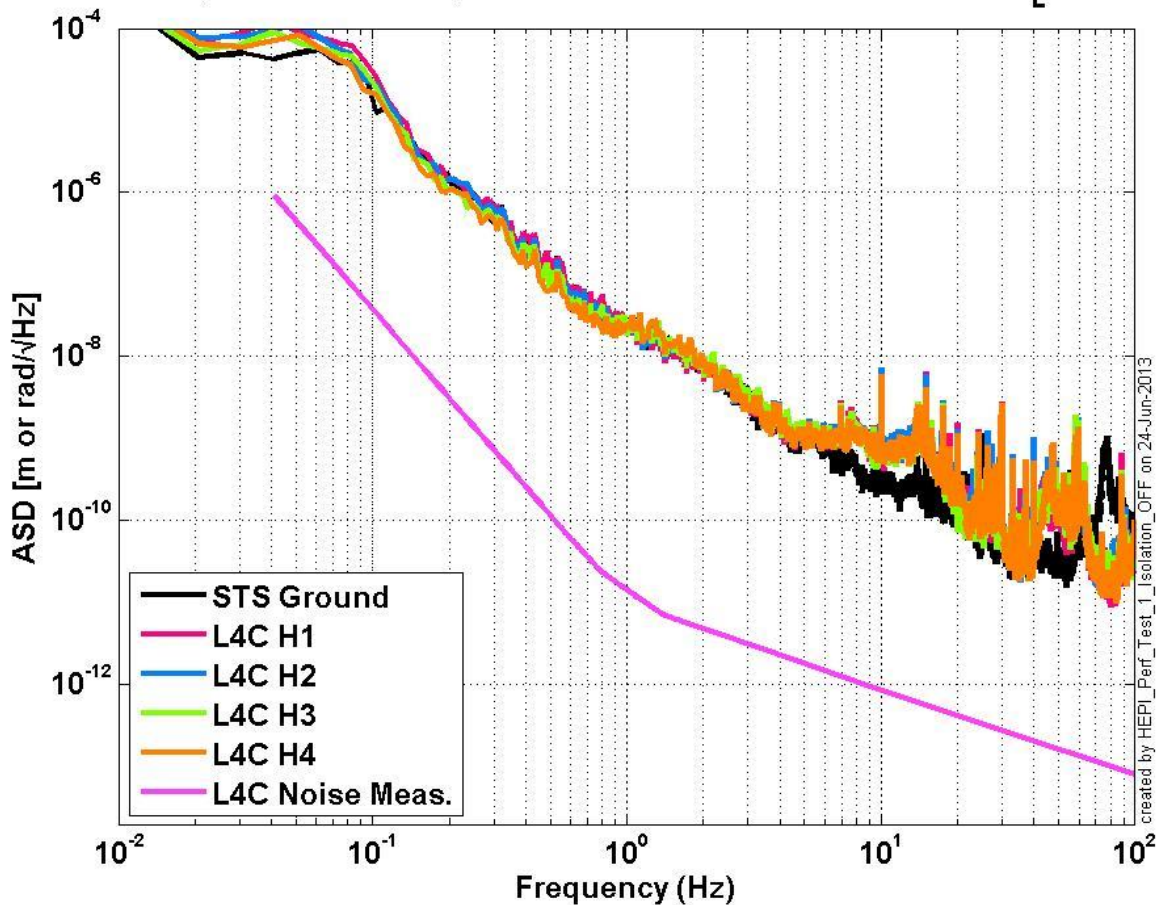

Figure 14: L1 HAM 4 HEPI Sensor spectra Horizontal L4Cs

L1 HAM4-HEPI, Local Sensors Spectra: Vertical L4C 2013-06-24-HEPI_level1-ISI_level2

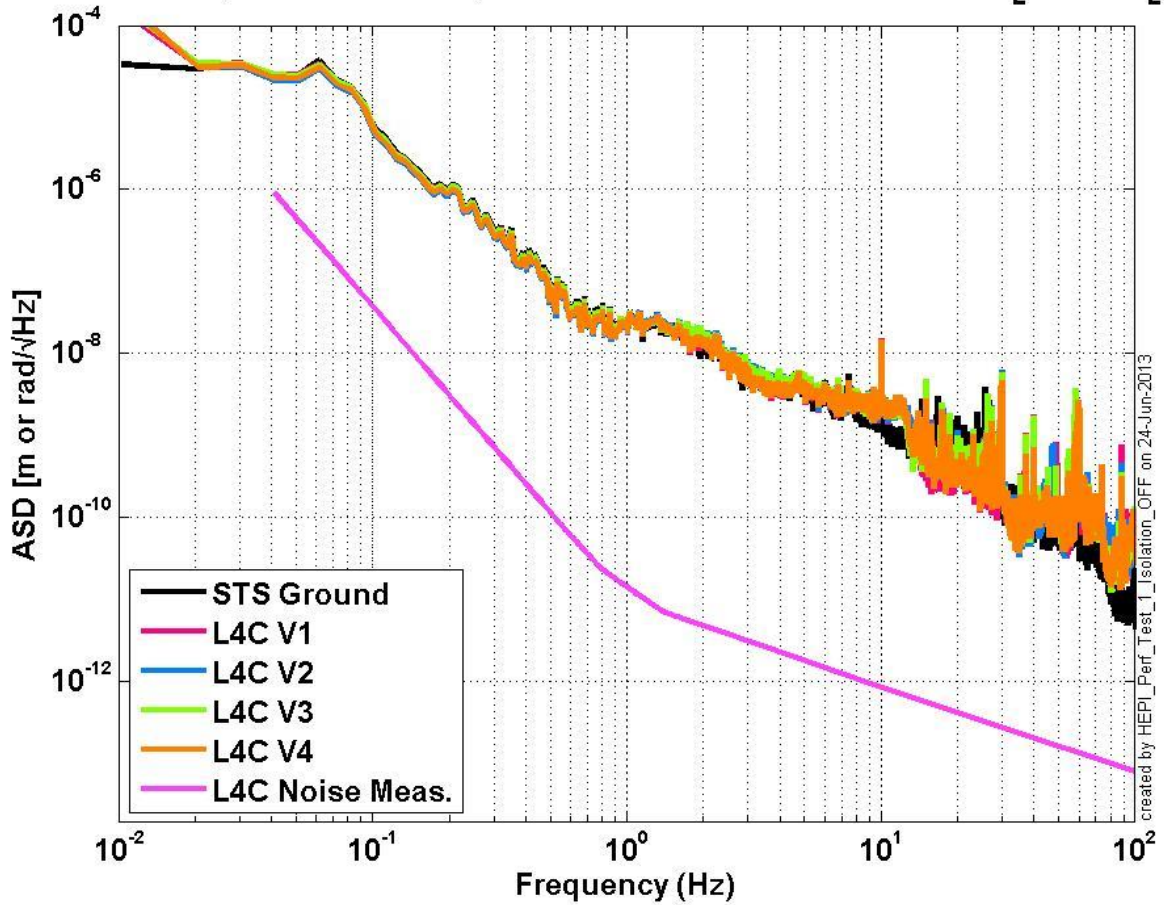

Figure 15: L1 HAM 4 HEPI Sensor spectra Vertical L4Cs

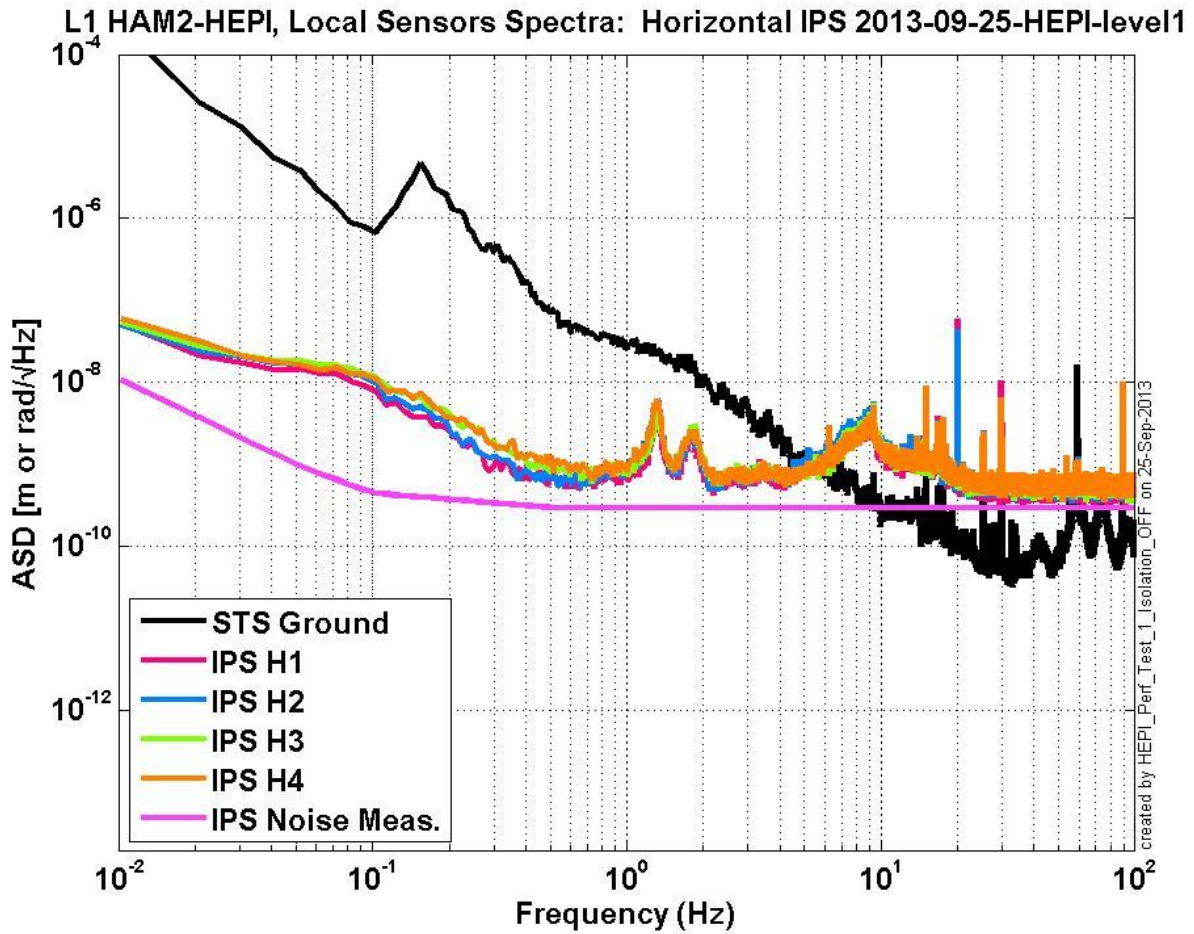

Figure 16: L1 HAM 4 HEPI Sensor spectra Horizontal IPSs

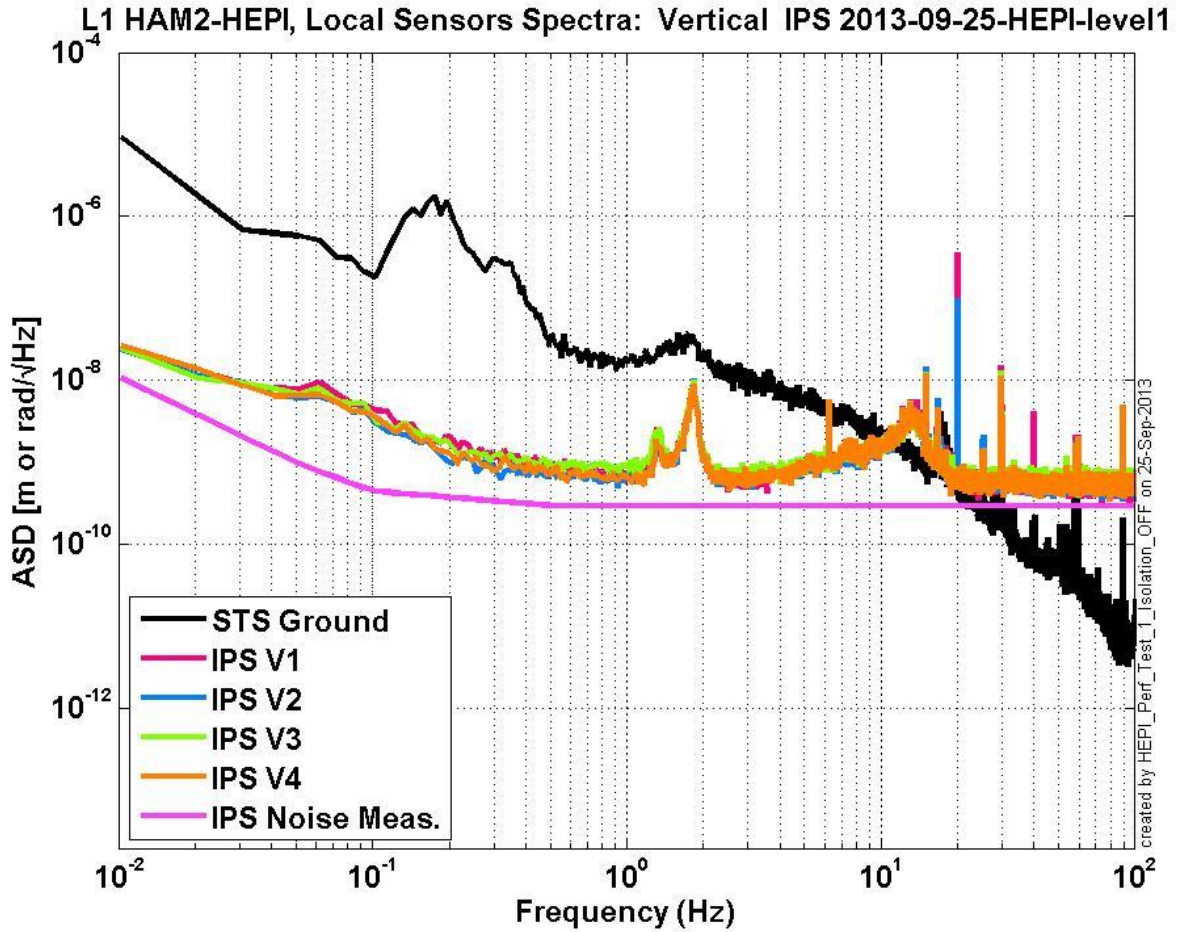

Figure 17: L1 HAM 4 HEPI Sensor spectra Vertical IPSs

Issues/difficulties/comments regarding this test:

Acceptance criteria:

Test result: Passed: X Failed: Waived:

1.8 SUS-watchdogs interaction test

Note: This test will be obsolete very soon, as the payload-HEPI WD connection is planned for removal.

- . Set up a zero value on the payload watchdogs.
- . Check that the payload watchdog screen of HEPI tripped.
- . In the payload watchdog screen, click on the OVERRIDE button and reset the watchdog.
- . Do the same process for all the payloads

Acceptance criteria:

- The HEPI must trip when the payload watchdogs are tripped
- The HEPI watchdogs could be reset when the OVERRIDE button is ON
- **Test result:** **Passed:** X **Failed:** **Waived:**

Note: When this test is done, reset everything (OVERRIDE button OFF, put back the value on the payload watchdog).

1.9 Static Test local drive

Scripts files for processing in SVN at:

/SeiSVN/seismic/HEPI/Common/Testing_Functions_HEPI/Static_Test_Local_Basis_HEPI.m

Data in SVN at:

SeiSVN/seismic/HEPI/L1/HAM4/Data/Static_Tests/L1_HPI_HAM4_Offset_Local_Drive_20130510.mat

. Drive of 100 counts (in progress)

	H1	H2	H3	H4	V1	V2	V3	V4
H1	8390.9418	-5056.1049	-327.0384	-1879.51872	-178.9088	209.3388	192.18836	-370.0864
H2	-4104.049	8306.5349	-1822.531974	-448.11792	134.8916	-100.465	-301.80668	139.7868
H3	-233.5984	-2065.5751	8170.4572	-4615.56692	178.7694	-183.7838	-239.1095	118.1154
H4	-1807.7793	-701.3897	-4558.2268	9000.50088	-488.2914	367.591	-1.00976	-441.0128
V1	-87.0864	1.56718	302.0506	-174.51156	7490.8344	918.82254	-1656.35338	784.3534
V2	182.2748	-404.56522	-128.0876	486.57564	833.8752	7402.042	675.00182	-1629.1482
V3	309.8688	-477.33554	-80.087	272.82164	-1436.731	1099.12212	7236.42762	695.124
V4	-177.839	74.78868	291.7698	-126.46464	955.694	-1414.8926	824.44686	7487.4108

Table 1: Main couplings and cross couplings for 100count offset

. Drive of 1000 counts (in progress)

	H1	H2	H3	H4	V1	V2	V3	V4
H1	8390.9418	-5056.1049	-327.0384	-1879.51872	-178.9088	209.3388	192.18836	-370.0864
H2	-4104.049	8306.5349	-1822.531974	-448.11792	134.8916	-100.465	-301.80668	139.7868
H3	-233.5984	-2065.5751	8170.4572	-4615.56692	178.7694	-183.7838	-239.1095	118.1154
H4	-1807.7793	-701.3897	-4558.2268	9000.50088	-488.2914	367.591	-1.00976	-441.0128
V1	-87.0864	1.56718	302.0506	-174.51156	7490.8344	918.82254	-1656.35338	784.3534
V2	182.2748	-404.56522	-128.0876	486.57564	833.8752	7402.042	675.00182	-1629.1482
V3	309.8688	-477.33554	-80.087	272.82164	-1436.731	1099.12212	7236.42762	695.124
V4	-177.839	74.78868	291.7698	-126.46464	955.694	-1414.8926	824.44686	7487.4108

Table 2: Main couplings and cross couplings for 1000 count offset

. Drive of 5000 counts (Nominal value handled by testing script)

	H1	H2	H3	H4	V1	V2	V3	V4
H1								
H2								
H3								
H4								
V1								
V2								
V3								
V4								

Table 3: Main couplings and cross couplings for 5000 count offset

Issues/difficulties encountered during this test:

Acceptance criteria:

- The results in these three tables must be the same (within xxx%)

Test result:

Passed: ____

Failed: ____

Waived: ____

1.10 Linearity Test/Range of motion in the local basis

Scripts files for processing and plotting in SVN at:

/SeiSVN/seismic/HEPI/Common/Testing_Functions_HEPI/Linearity_Test_Awgstream_HEPI.m

Data in SVN at:

SeiSVN/seismic/HEPI/L1/HAM4/Data/Linearity_Test/L1_HPI_HAM4_Linearity_test_20130521T165512.mat

Figures in SVN at:

/SeiSVN/seismic/HEPI/L1/HAM4/Data/Figures/Linearity_Test/L1_HPI_HAM4_Linearity_test_20130521T165512.fig

	Slopes	Offsets	Average Slope	Difference / Average in %
H1	-1.95	10115.78	-1.67	-16.94
H2	-1.45	812.65		13.04
H3	-1.7	-2306.25		-1.95
H4	-1.57	-7975.59		5.85
V1	-1.44	3668.89	-1.54	6.19
V2	-1.45	-4205.36		5.54
V3	-1.78	611.54		-15.96
V4	-1.47	3233.16		4.23

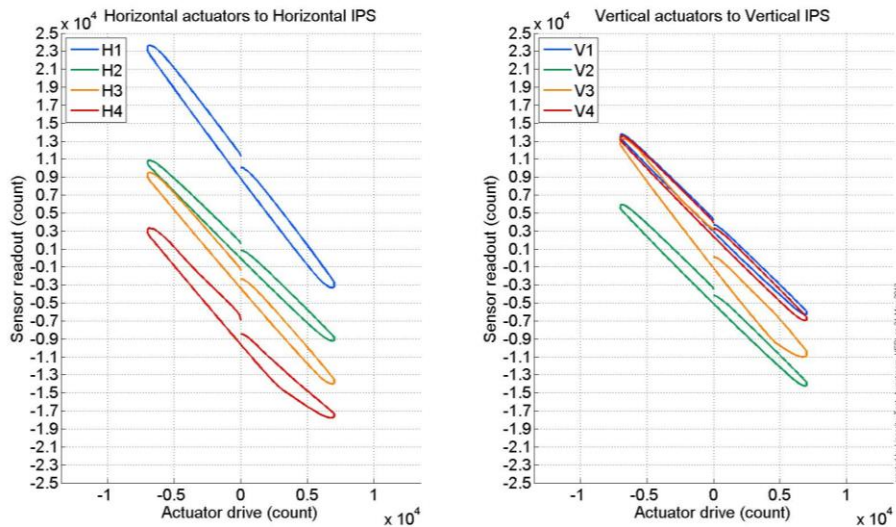

Figure 18: Linearity Test

Scripts files for processing in SVN at:

/SeiSVN/seismic/HEPI/Common/Testing_Functions_HEPI/Static_Test_Local_Basis_HEPI.m

Data in SVN at:

*SeiSVN/seismic/HEPI/L1/HAM4/Data/Static_Tests/
- L1_HPI_HAM4_Range_Of_Motion_20130520.mat*

	Positive Drive	At Rest	Negative Drive	Amplitude
H1	32767.00	1951.00	-12020.87	44787.87
H2	22924.17	2641.00	-17710.63	40634.81
H3	24146.02	-1942.00	-24775.31	48921.33
H4	22143.15	-3844.00	-27469.69	49612.84
V1	25373.23	3632.00	-16713.67	42086.90
V2	17581.54	-4367.00	-23045.33	40626.87
V3	28309.07	-1062.00	-26437.02	54746.09
V4	25086.32	2626.00	-18336.13	43422.45

Table 4: Range of Motion

Issues/difficulties encountered during this test:

Acceptance criteria:

- For the linearity test, the results in these three tables must be the same (within +/- 20% compared to the average slopes)
- For the range of motion, the sign must be positive for a positive drive and negative for a negative drive, and the amplitude must be bigger than 40000 counts.

Test result:

Passed: X

Failed: __

Waived: __

1.11 Actuator Plate to Shields gap

Note: Perform this test ONLY if the range of motion test failed.

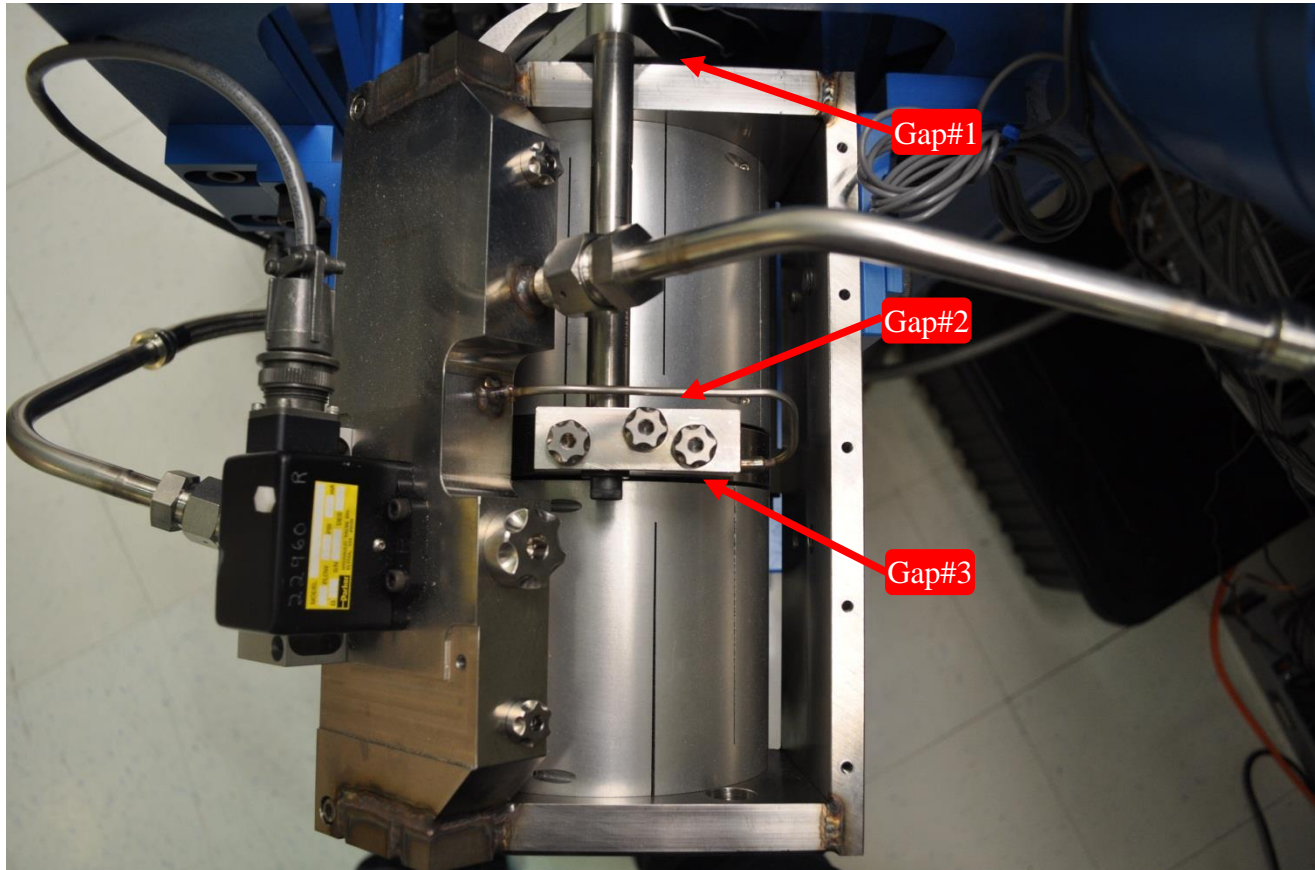

Figure 19: Locations of the actuator gaps to check if Step 1.10 Linearity Test/Range of motion in the local basis failed

Three gaps per actuator need to be checked as shown on Figure 19: Locations of the actuator gaps to check if Step 1.10 Linearity Test/Range of motion in the local basis failed .

	Horizontal			Vertical		
	Gap #1	Gap #2	Gap #3	Gap #1	Gap #2	Gap #3
Pier 1	Go	Go	Go	Go	Go	Go
Pier 2	Go	Go	Go	Go	Go	Go
Pier 3	Go	Go	Go	Go	Go	Go
Pier 4	Go	Go	Go	Go	Go	Go

Acceptance criteria:

- A 0.1” shim must fit into the gap #1
- A 0.05 shim must fit into gap #2 and #3

Test result: **Passed:** **Failed:** **Waived:** X

1.12 Valve Check

Scripts files for processing and plotting in SVN at:

`/SeiSVN/seismic/HEPI/L1/HAM4/Scripts/Valve_Check/plot_valve_check.m`

`/SeiSVN/seismic/HEPI/L1/HAM4/Scripts/Valve_Check`

Figures in SVN at:

`/SeiSVN/seismic/HEPI/L1/HAM4/Data/Figures/Valve_Check/Individual_Tests/Valve_Check_18-Jun-2013_14:19:22.fig`

`/SeiSVN/seismic/HEPI/L1/HAM4/Data/Figures/Valve_Check/Evolution/L1_HAM4_IPS_Valve_Check_From_07-May-2013_Until_18-Jun-2013.fig`

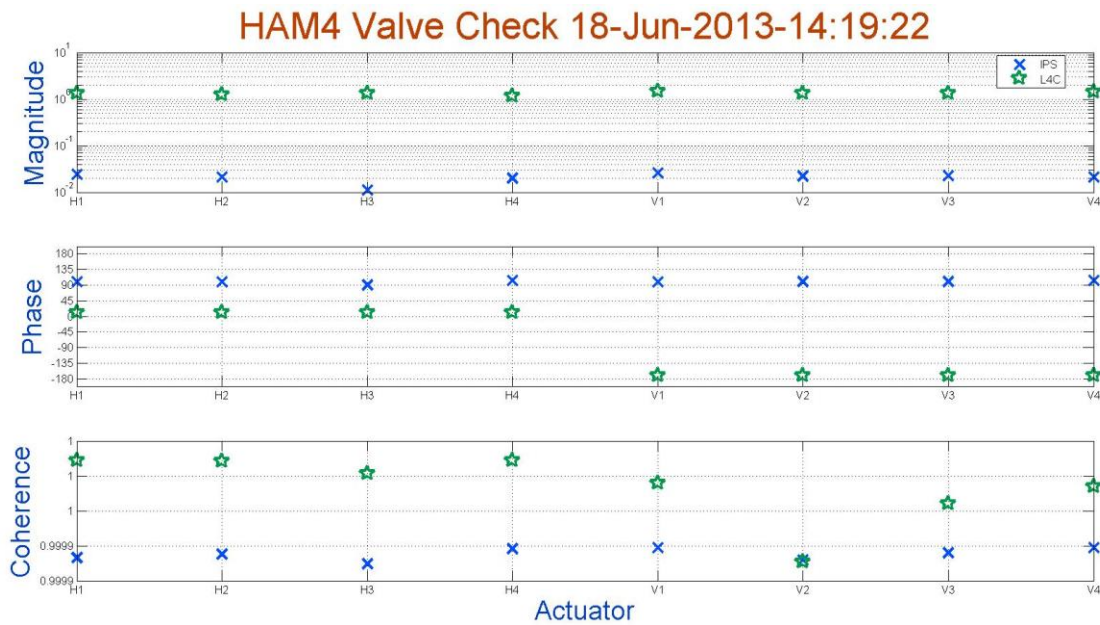

Figure 20: Valve check individual plot

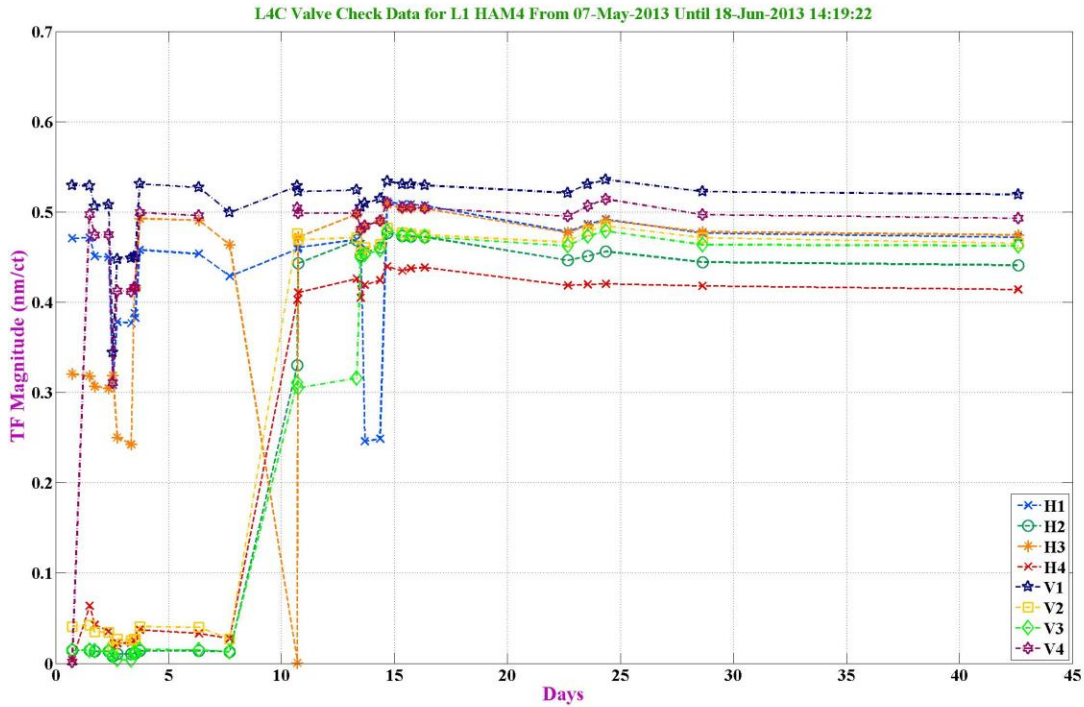

Figure 21: Valve check evolution plot

Acceptance criteria:

▪

▪ Test result: Passed: X Failed: Waived:

1.13 Local-to-local measurements

Band (Hz)	Resolution	Amplitude	Nreps	Time (s)	Time (min)	Time (h)
100 - 500	0.5	4000 - 4000	250	4176	69.6	1.2
10 - 100	0.25	4000 - 4000	200	6592	109.9	1.8
0.7 - 10	0.05	4000 - 4000	75	12320	205.3	3.4
0.1 - 0.7	0.025	4000 - 4000	30	10080	168.0	2.8
0.01 - 0.1	0.01	4000 - 4000	10	8960	149.3	2.5
0.002 - 0.01	0.002	4000 - 4000	2	12160	202.7	3.4
						15.1

Data files in SVN at:

/SeiSVN/seismic/HEPI/L1/HAM4/Data/Transfer_Functions/Measurements/Undamped/

- L1_HEPI_HAM4_0p05_to_0p5Hz_20130530-165220.mat
- L1_HEPI_HAM4_0p5_to_2Hz_20130529-180144.mat
- L1_HEPI_HAM4_2_to_20Hz_20130529-211023.mat
- L1_HEPI_HAM4_20_to_100Hz_20130529-230422.mat

- L1_HEPI_HAM4_100_to_250Hz_20130530-012101.mat

Data collection script files:

/SeiSVN/seismic/HEPI/Common//Transfer_Function_Scripts/

- Run_TF_L2L_10mHz_100mHz.m
- Run_TF_L2L_100mHz_500mHz.m
- Run_TF_L2L_500mHz_5Hz.m
- Run_TF_L2L_5Hz_100Hz.m
- Run_TF_L2L_100Hz_1000Hz.m

Scripts files for processing and plotting in SVN at:

/SeiSVN/seismic/HEPI/L1/HAM4/Scripts/Control_Scripts/Version_5/

- Step_1_TF_Loc_to_Loc_L1_HEPI_HAM4.m

Figures in SVN at:

/SeiSVN/seismic/HEPI/L1/HAM4/Data/Figures/Transfer_Functions/Measurements/Undamped/

- L1_HPI_HAM4_TF_L2L_Raw_from_ACT_to_IPS_2013_05_30.fig
- L1_HPI_HAM4_TF_L2L_Raw_from_ACT_to_L4C_2013_05_30.fig

Storage of measured transfer functions in the SVN at:

/SeiSVN/seismic/HEPI/L1/HAM4/Data/Transfer_functions/ Simulations/Undamped/

- L1_HPI_HAM4_TF_L2L_Raw_2013_05_30.mat

The local-to-local transfer functions are presented below.

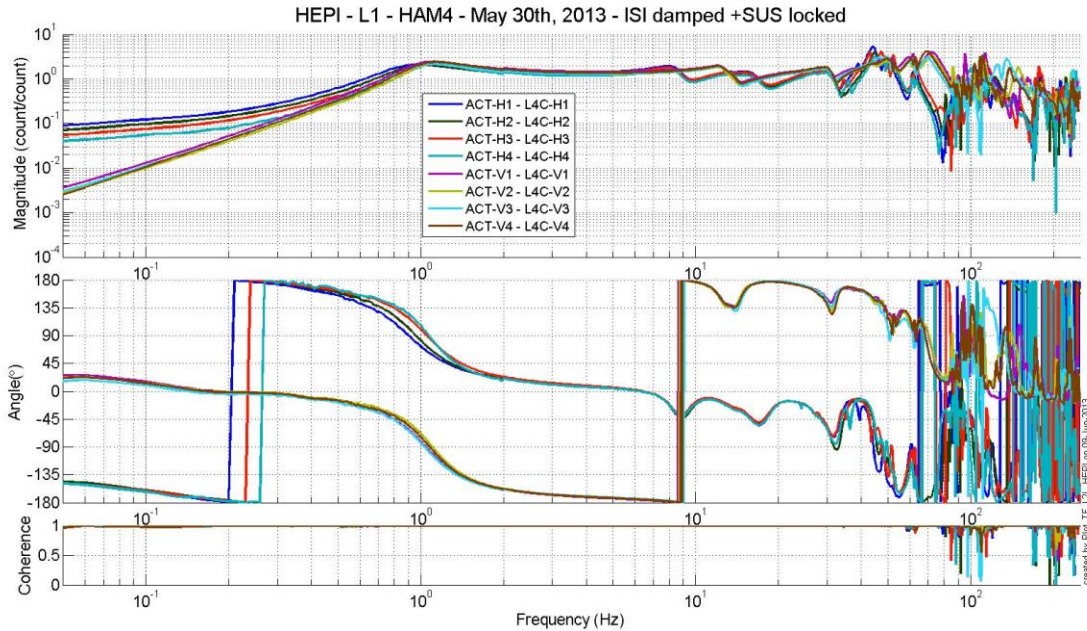

Figure 22:L1 HAM 4 HEPI Act to L4C Transfer Functions

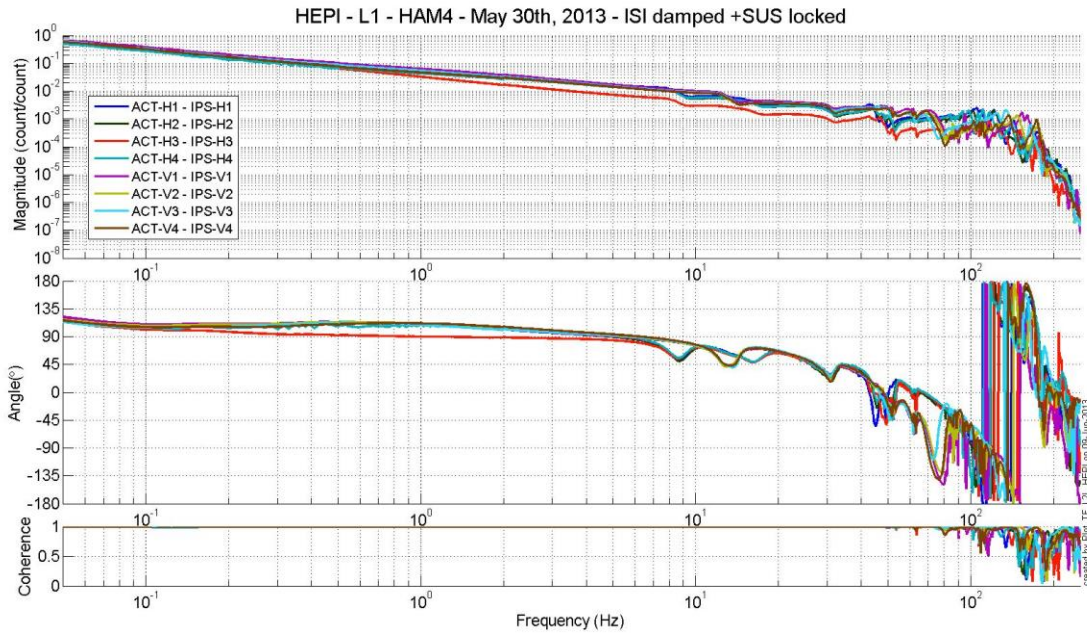

Figure 23: L1 HAM 4 HEPI Act to IPS Transfer Functions

Issues/difficulties/comments regarding this test:

Acceptance criteria:

- On IPS, the phase must be 0° at DC
- On geophones, the phase must be 90° at DC
- Identical shape in each corner

Test result:

Passed: X

Failed:

Waived:

1.14 Alignment offsets:

Those are the IPS readouts that were recorded with HEPI locked, after alignment work was performed. The opposite of those values is to be installed as offset of the IPS filter banks when the Isolation loops are turned on. This way, HEPI will be operating in its *preferred alignment* state.

	IPS Readouts HEPI Locked	Offset Value
H1		
H2		
H3		
H4		
V1		
V2		
V3		
V4		

Acceptance criteria:
Offsets were recorded.

Test result: **Passed:** ____ **Failed:** ____ . **Waived:** . ____.

Conclusion

L1 HAM 4 HEPI seems good so far, we still have a few tests to run but should not have any issue with it. Here is a list of the tests that will be done:

- 1.1 Load Cell Assembly: the value will be recorded in this document
- 1.4 Check Stops Gaps: this test will be done when we unlock HEPI on L1 HAM 4
- 1.6 IPS Centering
- 1.9 Static Test Local Drive
- 1.14 Alignment Offsets

Some of the tests have been waived:

- 1.2 Bellows: the bellows are hard to access and tests are hard to proceed. After several discussions and brainstorming sessions, it has been decided not to measure the gaps on HEPI-HAM.
- 1.5 Gaps Check: this test can be waived if step 1.10 Linearity Test/Range of motion in the local basis passes because it means that the system has a full range of motion and is, therefore, free to move
- 1.11 Actuator Plate to Shield gap: this test was not performed because the Range of motion gave good results
-

So far, only 1.3 Boot Location fails, but the requirements might be a little bit too strict for this test and our results are in the ballpark, plus the other tests such as the Range of Motion and the Linearity test gives good results so this shouldn't prevent us from approving this HEPI if the rest of the tests are good.