

---

# A Proposed Capacitive Position Sensor Timing Synchronization and Distribution Solution

Ben Abbott

May 9, 2014

**G1400522-v1**

# The Problem

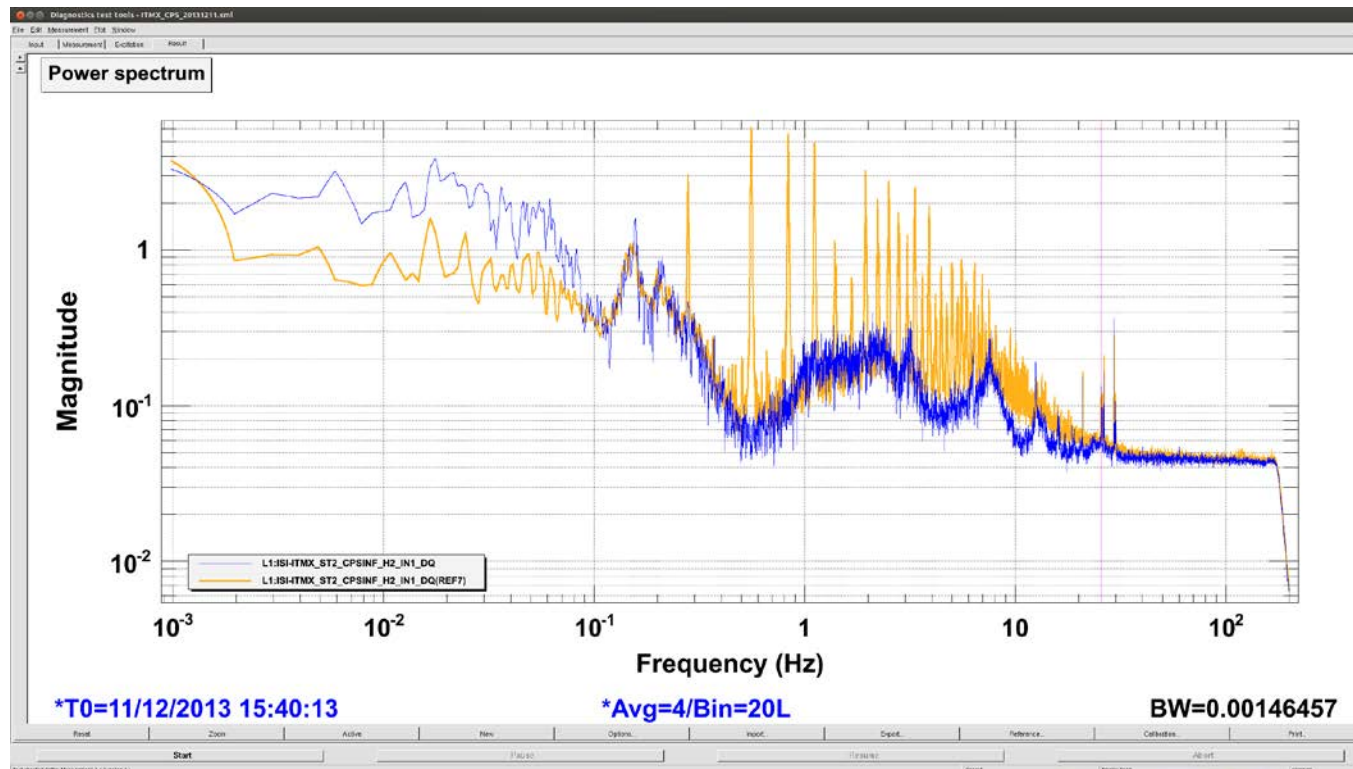

From a LIGO LLO Logbook report 10089. **Orange** trace is ITMX with all 3 chambers' CPSs on, **Blue** trace is ITMX with the other two chambers turned off.

# The Temporary Solution

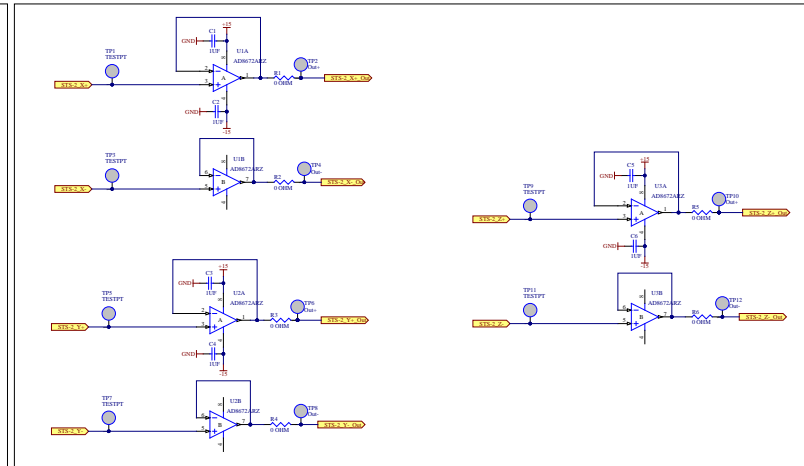
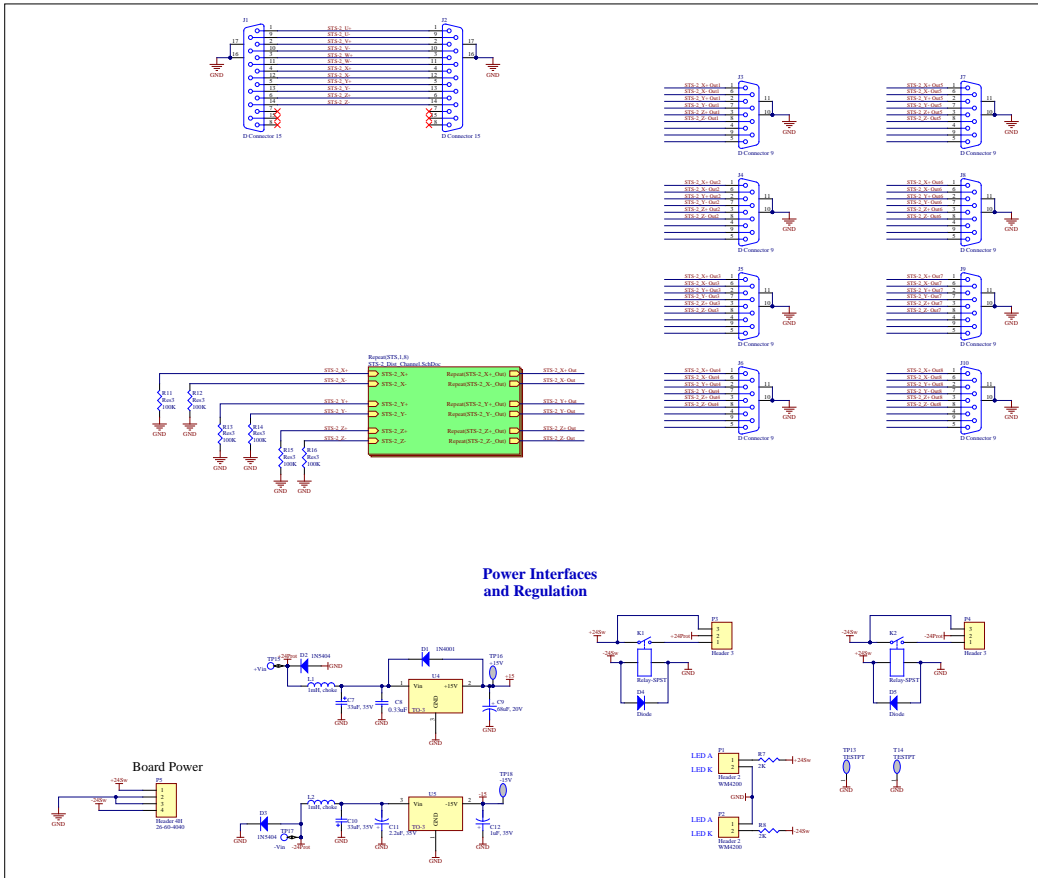

## Distribution Channels AD8672s

## STS-2 Distribution Chassis



# Preliminary Results

You can find attached sample spectra for the CPS sensors of all 3 BSC ISIs. In **orange** are the measurements from last Wednesday night when all 3 ISIs had different masters ("*comb reference*"), in **black** are the measurements from Sunday night with *both ITMY and BS on the same master and ITMX still running*, and in any **other colors** are the measurements from last night. In all cases, those measurements were taken with St1 ISI isolated, St 2 only damped. One can see that **there is no more comb visible on those spectra!**

Power spectrum

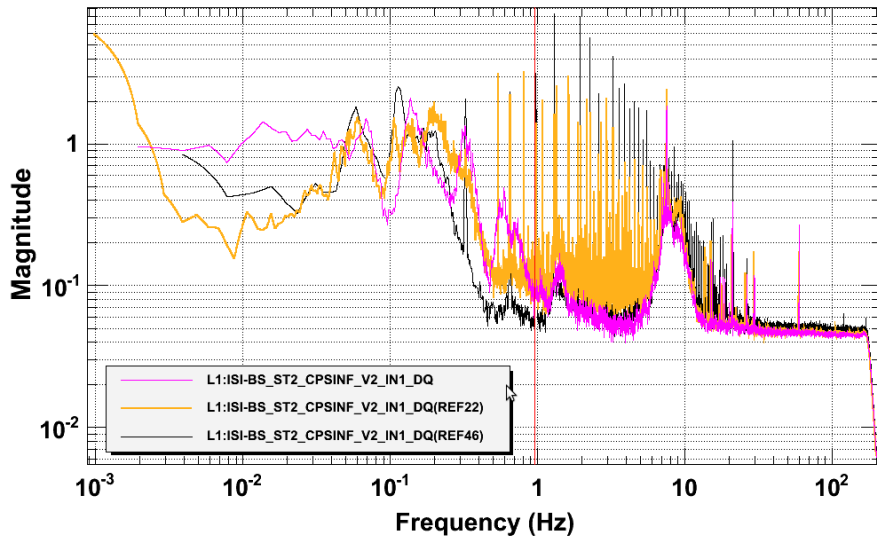

\*T0=28/01/2014 10:11:19

Avg=20/Bin=10L

\*BW=0.00292944

\*T0=28/01/2014 10:11:19

Power spectrum

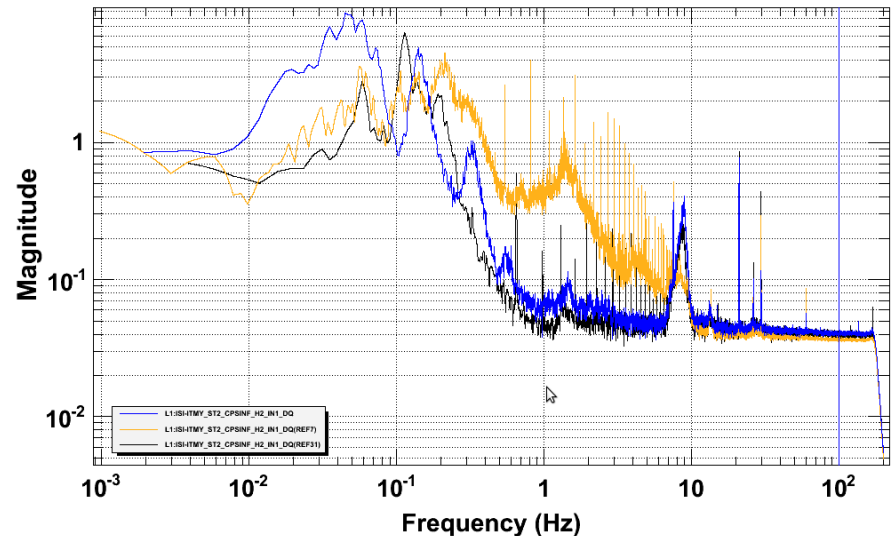

Avg=20/Bin=10L

\*BW=0.00292944

From aLIGO LLO Logbook Report 10629

## Problems with the STS-2 Dist. Approach

---

- AD8672s are analog OpAmps, and are not fast enough to recreate there high-frequency square pulses.
- The waveforms produced are ugly, sine-ish lumps, and are easily perturbed by people touching the system in any way.
- There is no synchronization to the site clock.
- We're going to need that STS-2 Distribution Chassis back.

# The Proposed Distribution Scheme



10MHz  
Reference synced  
to GPS clock



15.43980MHz  
Sine Wave

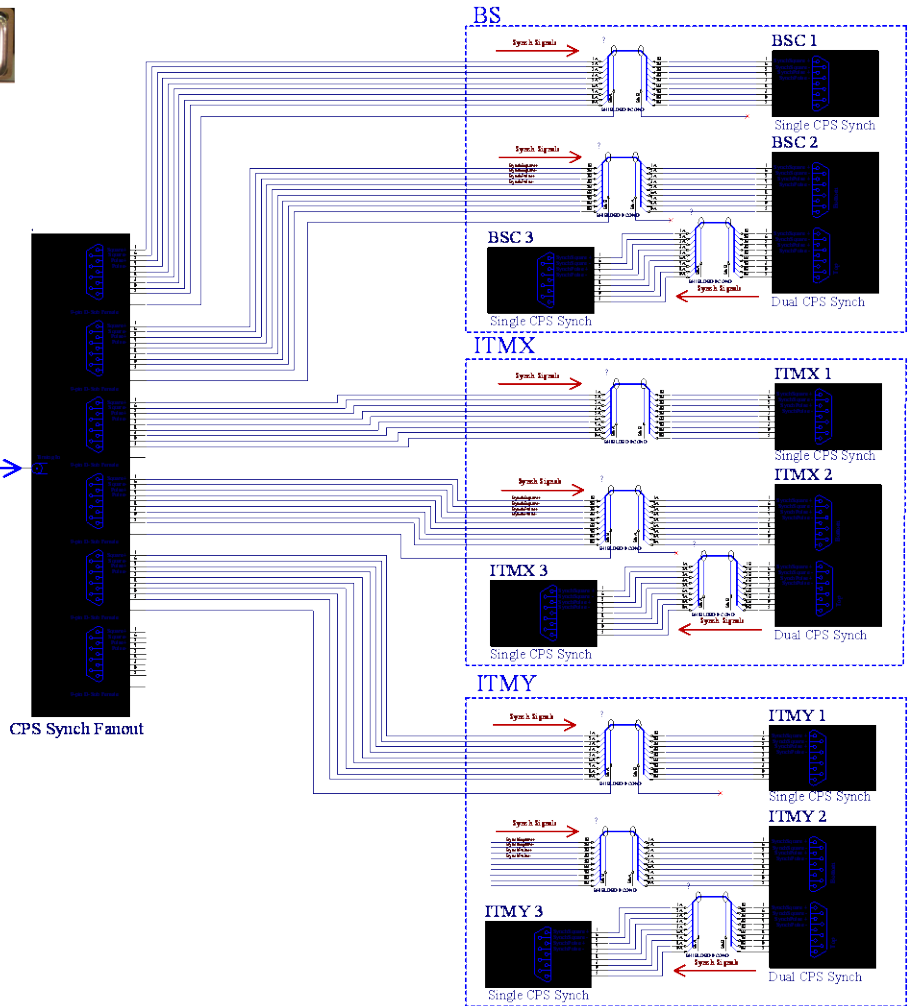

# The CPS Synch Board Schematic

15.43980 MHz Sine Wave

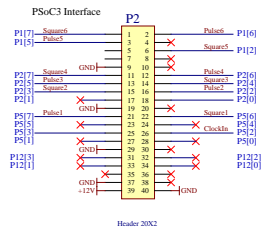
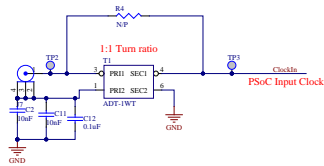

Header 20X2

Power In From Breaker

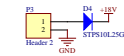

5 V Voltage Regulator

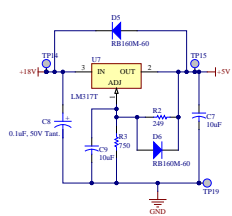

12V Voltage Regulator

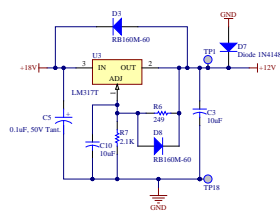

Board Power

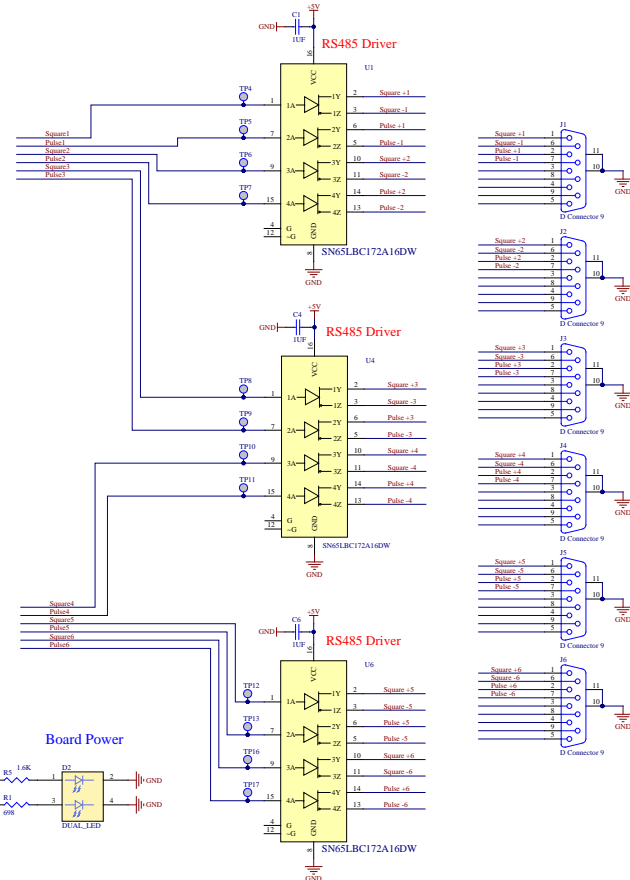
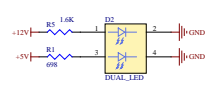



# The PSoC Program

15.43980MHz

From Signal  
Generator

Pin\_ClockIn  ← CLK In

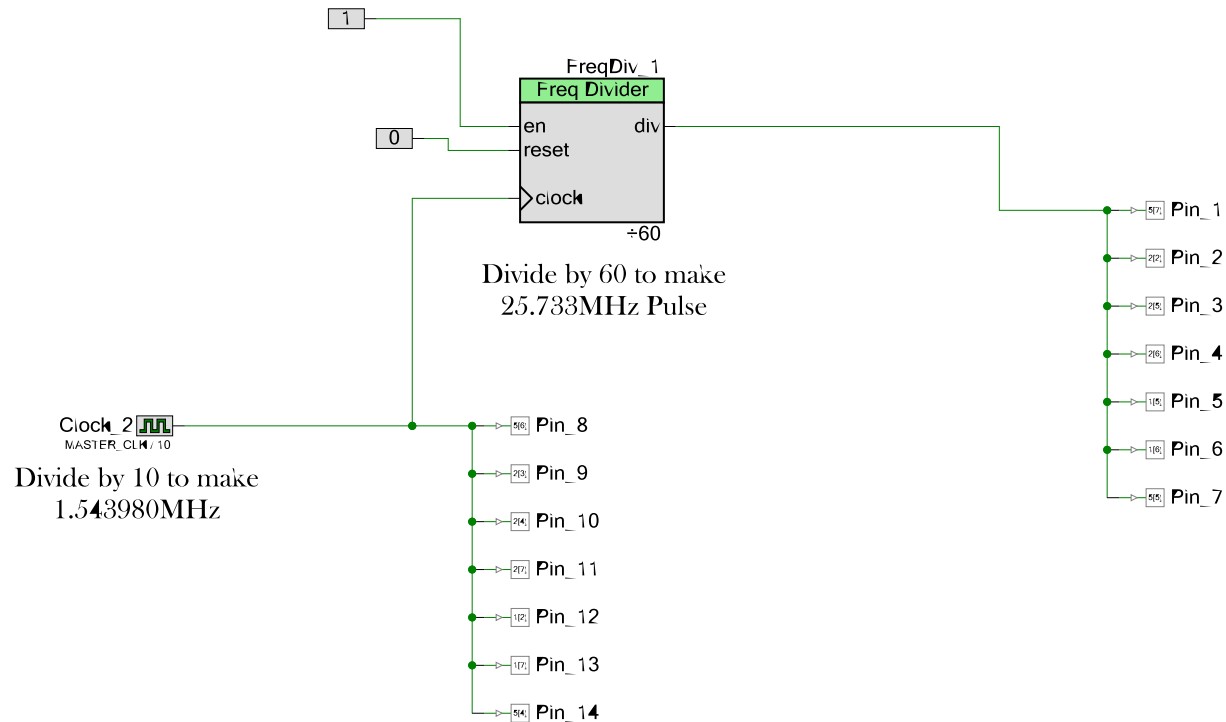

# The PSoC Frequency Divider

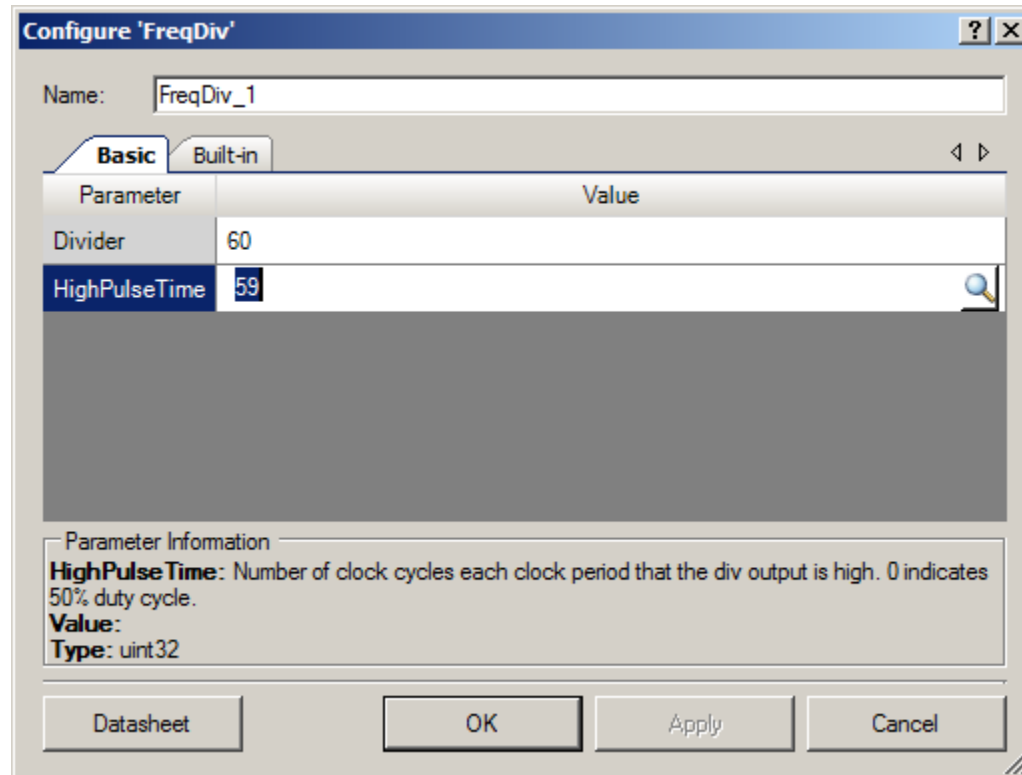

# Estimated Cost at the Vertex

---

(These numbers are raw, and contain no contingency)

- To fix the Vertex BSC Chambers only:
- Stanford DS345 (1 ea.) \$1,500
- CDS Electronics \$1,000
- Cables \$750
- Total = \$3,250 per IFO
  
- To Add HAMS:
- CDS Electronics \$1,000
- Cables \$700
- Total = \$1,700 additional per IFO

## Estimated Cost at the Ends

---

- To fix both End BSC Chambers:
- Stanford DS345 (2 ea.) \$3,000
- CDS Electronics \$2,000
- Cables \$700
- Total = \$5,700 per IFO
- There is currently no 10MHz clock at the End Station, so another timing synch solution would have to be thought up. \$?

As there is no crosstalk at the end stations, being that there is only one chamber, the only impetus to make this change would be to synch the CPS synch pulse to the site clock.

# LLO aLog Text (10089 & 10106)

L1 SEI

[Link](#)

celine.ramet@LIGO.ORG - posted 13:46, Wednesday 11 December 2013 - last comment - 21:25, Wednesday 11 December 2013(10089)

## **CPS Comb: ITMX measurements with ITMY+BS CPS powered off**

[Rich M, Marissa, Ryan, Celine]

Yesterday, we confirmed that the "comb" issue was visible on all 3 BSC-ISIs CPSs, and that it affected much more some individual CPSs than others. We were able to change which were the CPS most affected, but not to understand why or how. We did notice though that ITMY and ITMX comb seemed to start at different frequencies, while the BS one looked like a combination of the 2.

Suspecting interaction between chambers, this morning we shut down all CPSs of ITMY and BS (from 9:40 am to 10:35 am) and compared ITMX St2 CPS spectra with the other chambers CPSs powered on (ref in orange on the attached spectra) and off (in blue). [Shutting down the other chambers CPSs resulted on having ITMX comb disappear from ITMX St2 CPS spectra.](#)

We are now trying to understand the interaction between chambers in order to mitigate the issue in an effective way.

## **Comments related to this report**

**richard.mittleman@LIGO.ORG** - 21:25, Wednesday 11 December 2013 (10106)[Link](#)

We are now fairly convinced that the problem (a frequency comb in the CPS spectra) is due to having multiple master oscillators in close proximity (what close means is still to be determined).

We measured the frequencies of the sync pulses on the three BSC chambers (~25.733Khz) and found that the differences between the frequencies was about the same as the observed comb frequencies. We then powered down the ITMY ISI and eliminated the master oscillator on the ITMX ISI. We then added a cable to bring the sync signal from the BS chamber to the ITMX ISI. After doing this the ITMX ISI ran well and the CPS spectra showed no signs of a frequency comb. Unfortunately this loaded down the BS sync sufficiently so that it did not run well. the major problem was in the Stage 1 V1 CPS sensor (which is the master). So we restored everything to the way it was before and everything is running as it was previously.

It looks like the solution is going to be running neighbouring chambers off of the same master and installing a buffer amplifier so that more slaves can be driven then we currently can

Rich A. has suggested that we replace all of the local master/sync signals with a gps generated signal, then all of the chambers would be running at the same frequency

# LL0 aLog Text (10629)

L1 SEI

[Link](#)

celine.ramet@LIGO.ORG - posted 11:37, Tuesday 28 January 2014 (10629)

**All corner station BSC-ISI CPSs running from 1 Master**

[Ryan, Celine]

Since the comb observed on the CPS signals was observed to be linked to the beating of the 3 different BSC-ISI Master CPSs against each other ([alog 10106](#)), we have tried to have all BSC chambers from the corner station running from one master. Using one STS distribution box ([D0900351](#)) installed in the LVEA in the rack located at the -X/+Y corner of the BS, we have had the BS and ITMY running from the BS St1-H1 sensor used as Master since last Thursday ([alog 10584](#)). Yesterday, we connected ITMX to the same STS distribution interface and now all 3 BSC-ISI have only 1 CPS Master: BS St1-H1.

You can find attached sample spectra for the CPS sensors of all 3 BSC ISIs. In **orange** are the measurements from last Wednesday night when all 3 ISIs had different masters ("*comb reference*"), in **black** are the measurements from Sunday night with *both ITMY and BS on the same master and ITMX still running*, and in any other colors are the measurements from last night. In all cases, those measurements were taken with St1 ISI isolated, St 2 only damped. One can see that **there is no more comb visible on those spectra** (all other variations are likely due to variations in ground motion when those measurements were taken). Also, it is to be noted that high frequency noise (>30 Hz) has not gotten any worse with all those changes (we were worried about our grounding configuration).

Note that despite this success, this is only a temporary setup. We believe that the filtering in the STS distribution slows down the sync signal sent to the slave CPSs, and we're not sure how this might affect the ISI performances. Also, I have noticed that the system is very sensitive to any new connection made to that interface box, and that the BS sync signals need to be connected last and carefully to avoid issues. We believe that this is linked to some grounding problem. However, since it does not seem to affect ISI performances at this point, we haven't done (yet) any further investigation.

**All in all, this success gives us a proof of concept that we will be able to run with only 1 Master for all 36 BSC-ISI CPSs from the corner station, resulting in getting rid of the comb plegging our spectra.**

*Even though we can not explain this at this time, we do not see any signs of beating between HAM-ISI Master CPS.*