

D1500084-v2
 Daniel Sigg
 5/27/2015

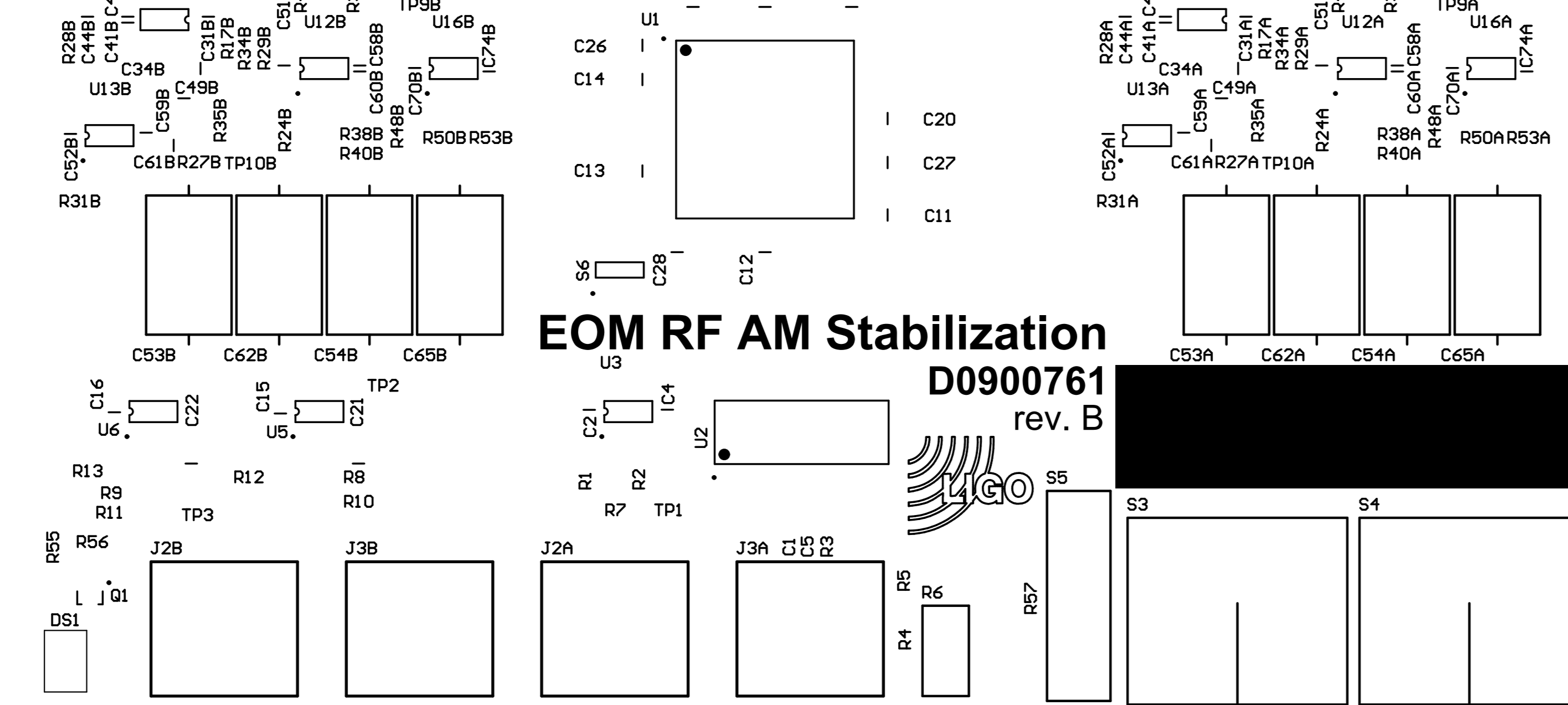

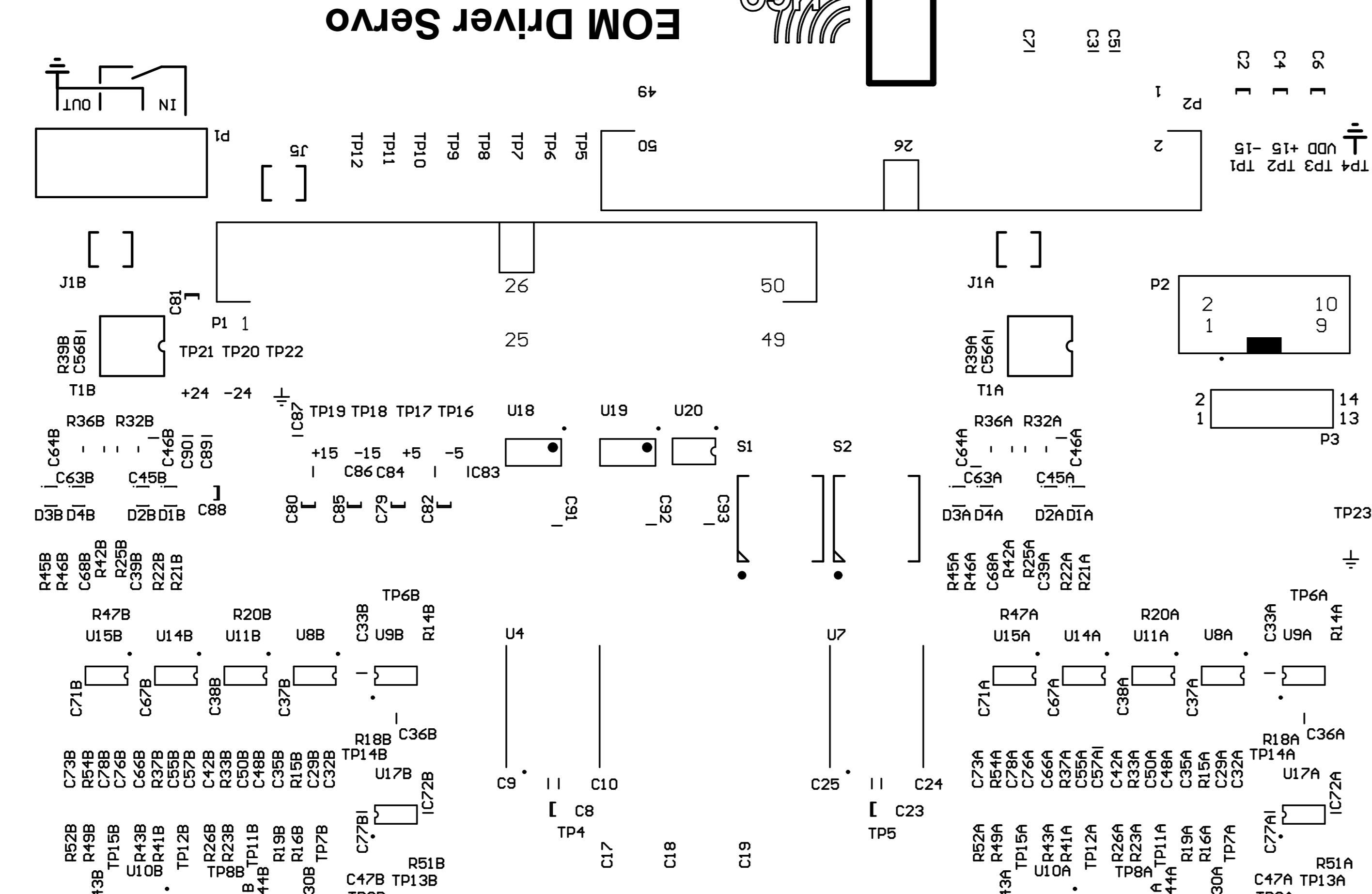

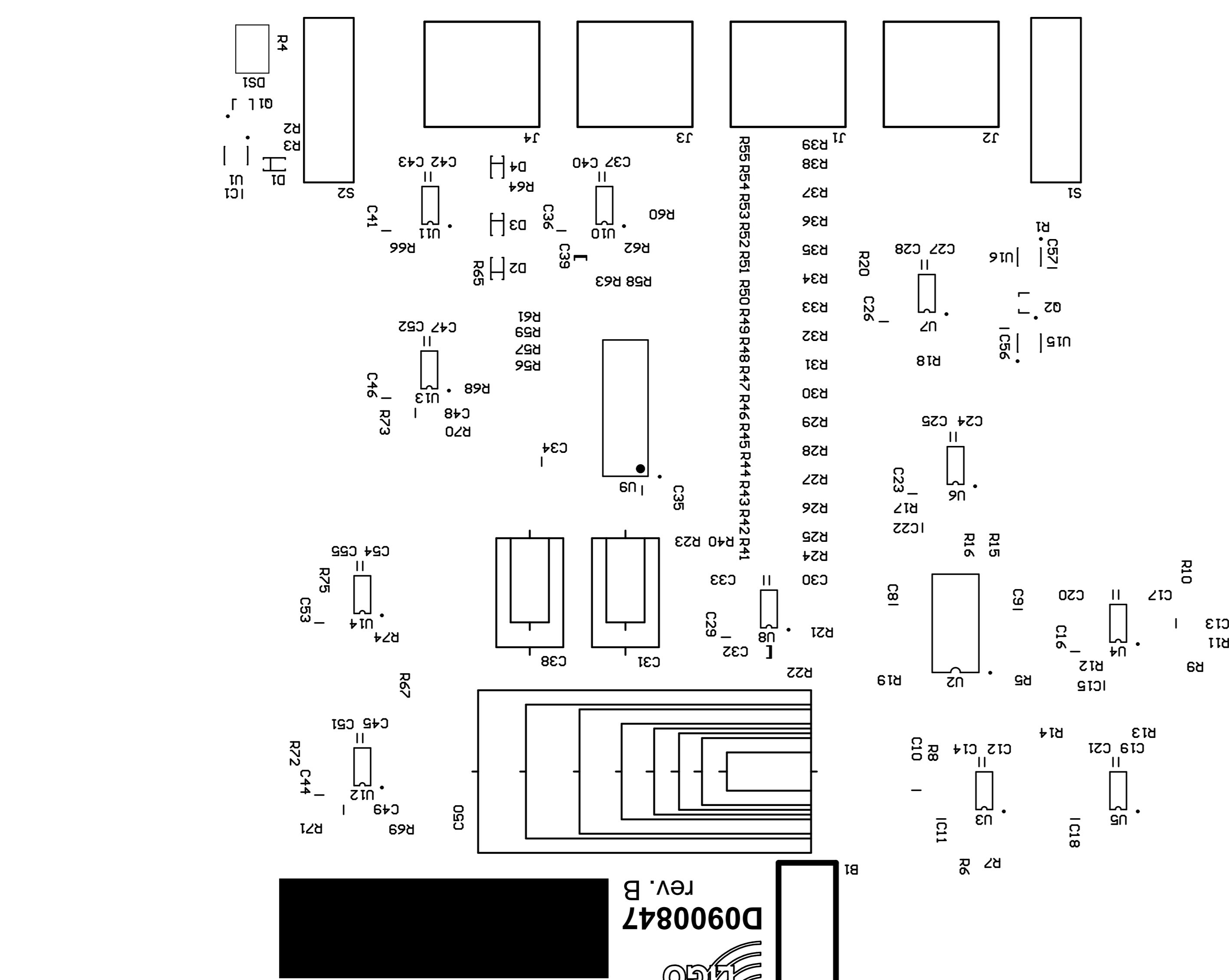
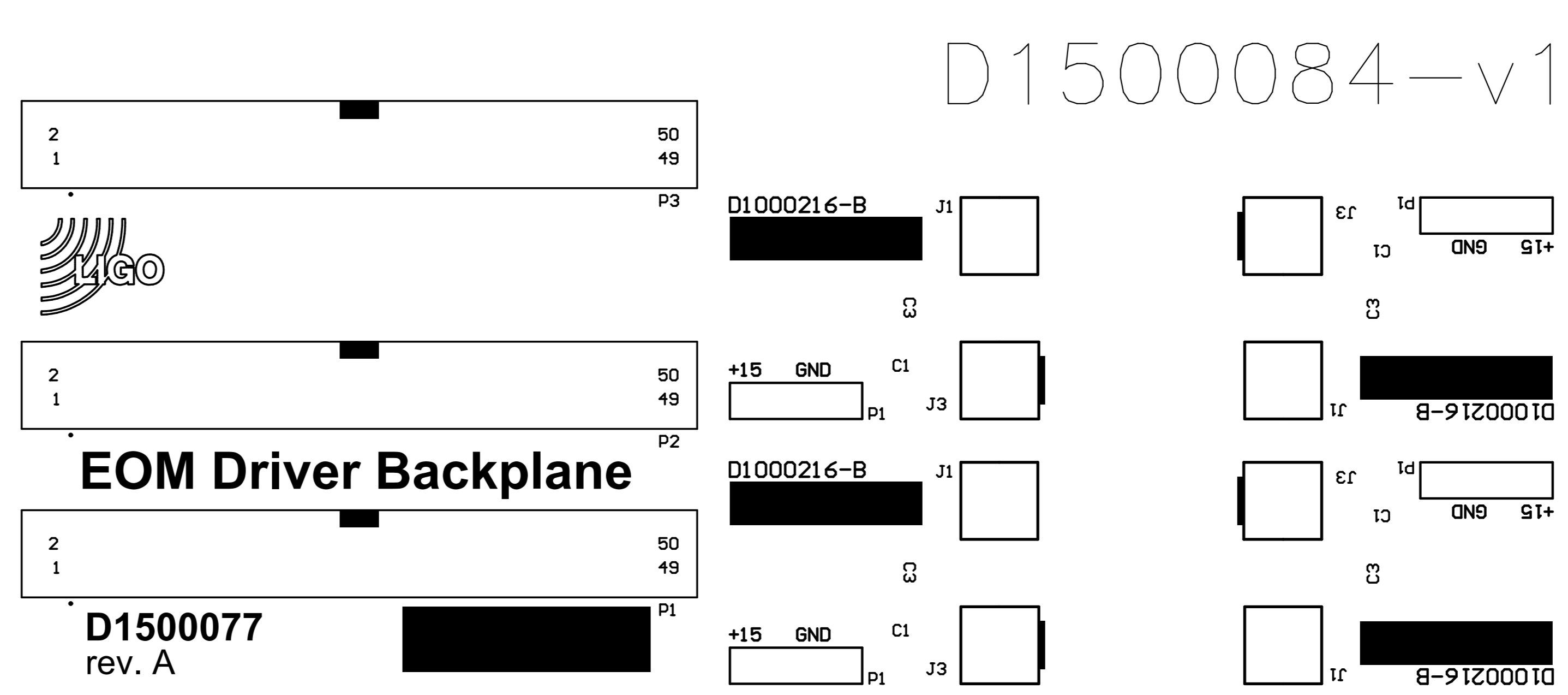
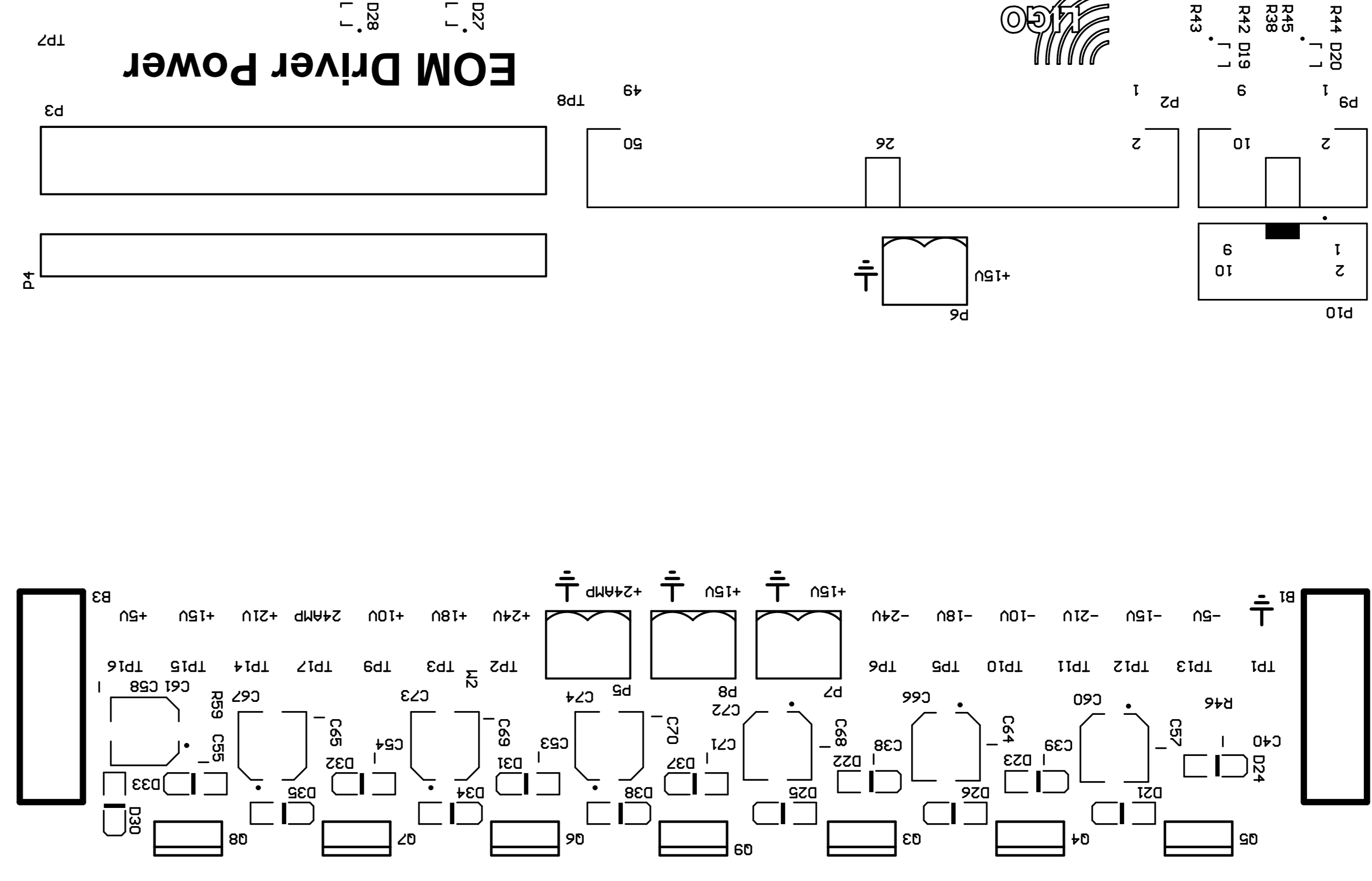
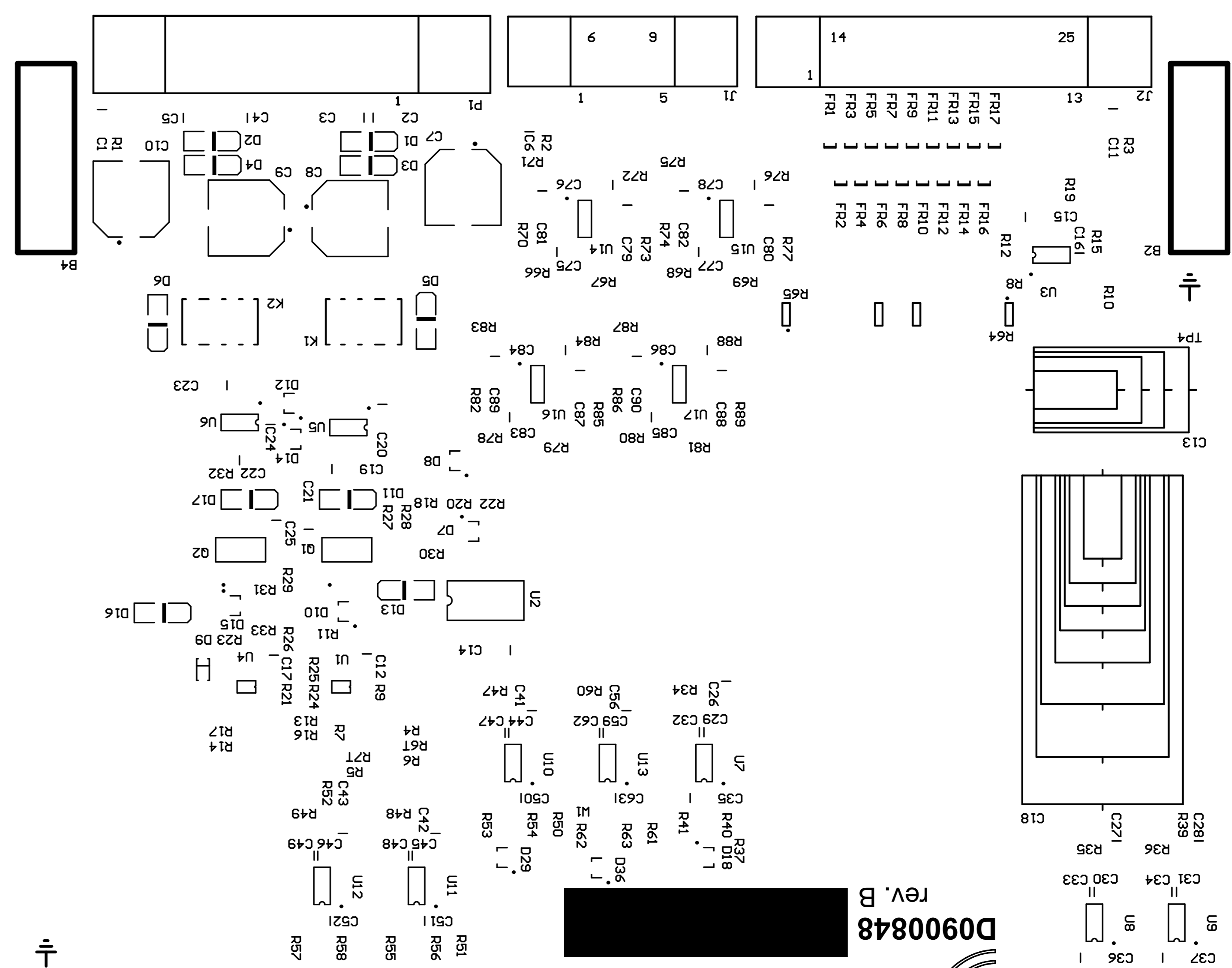
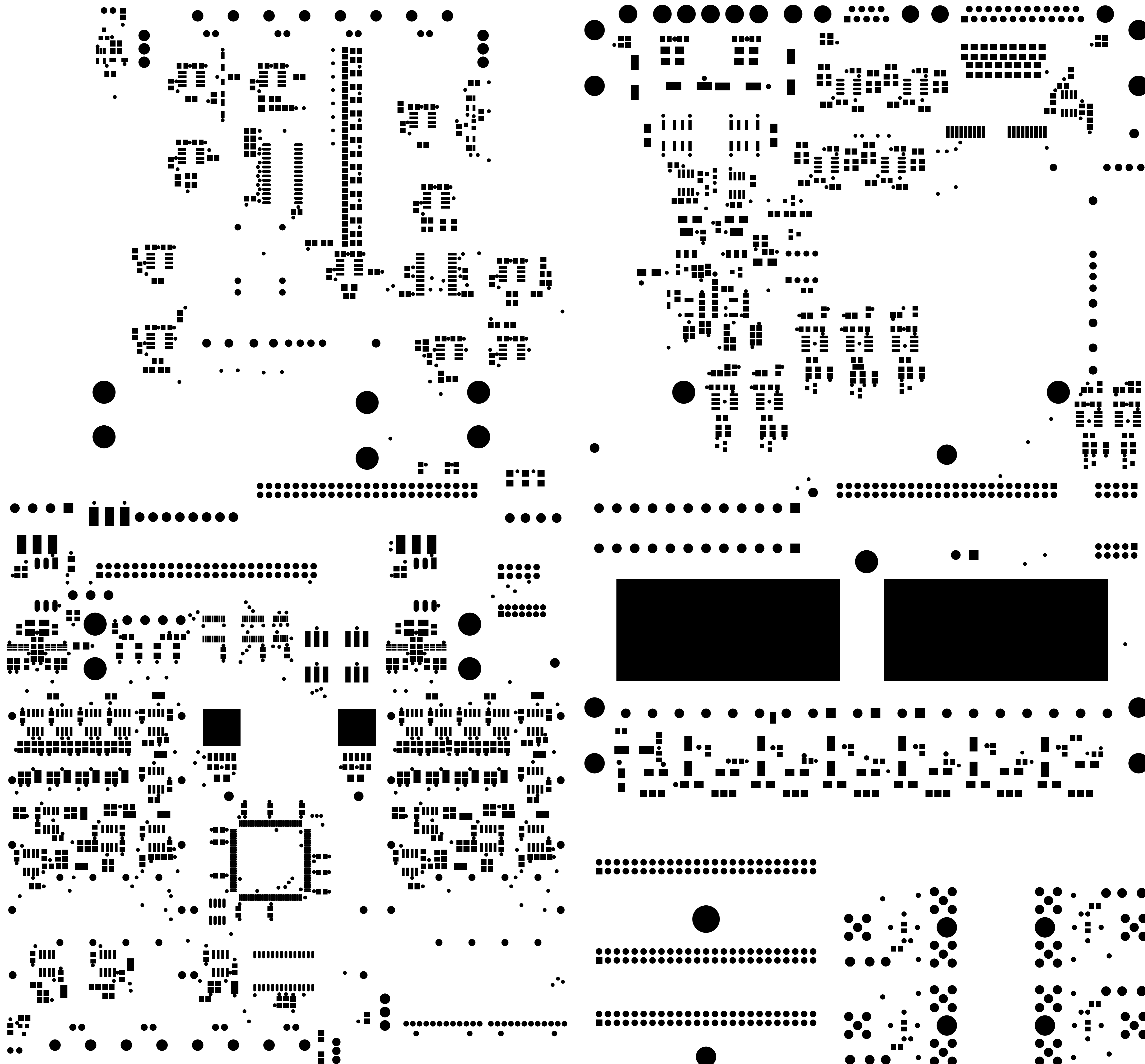
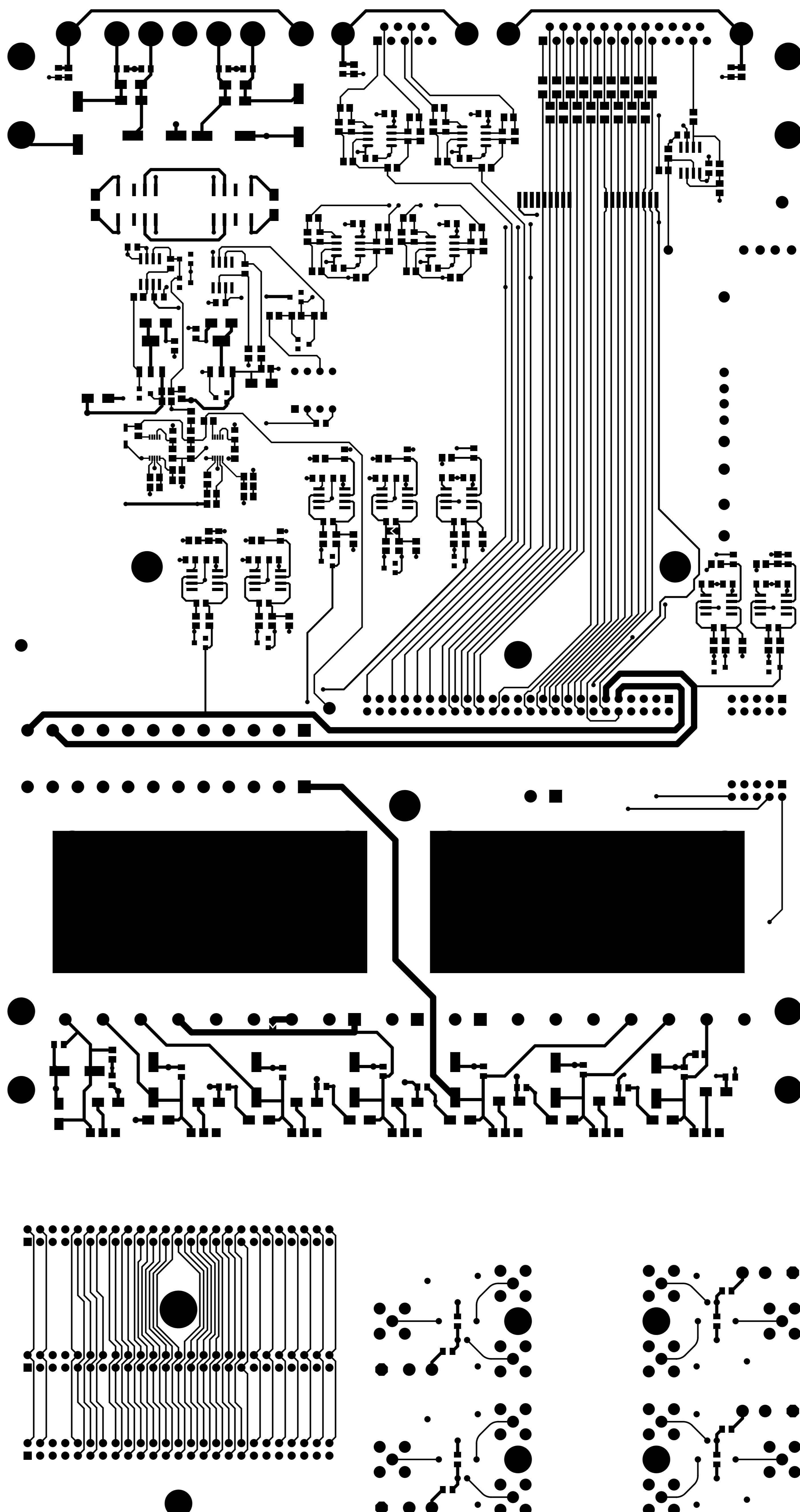
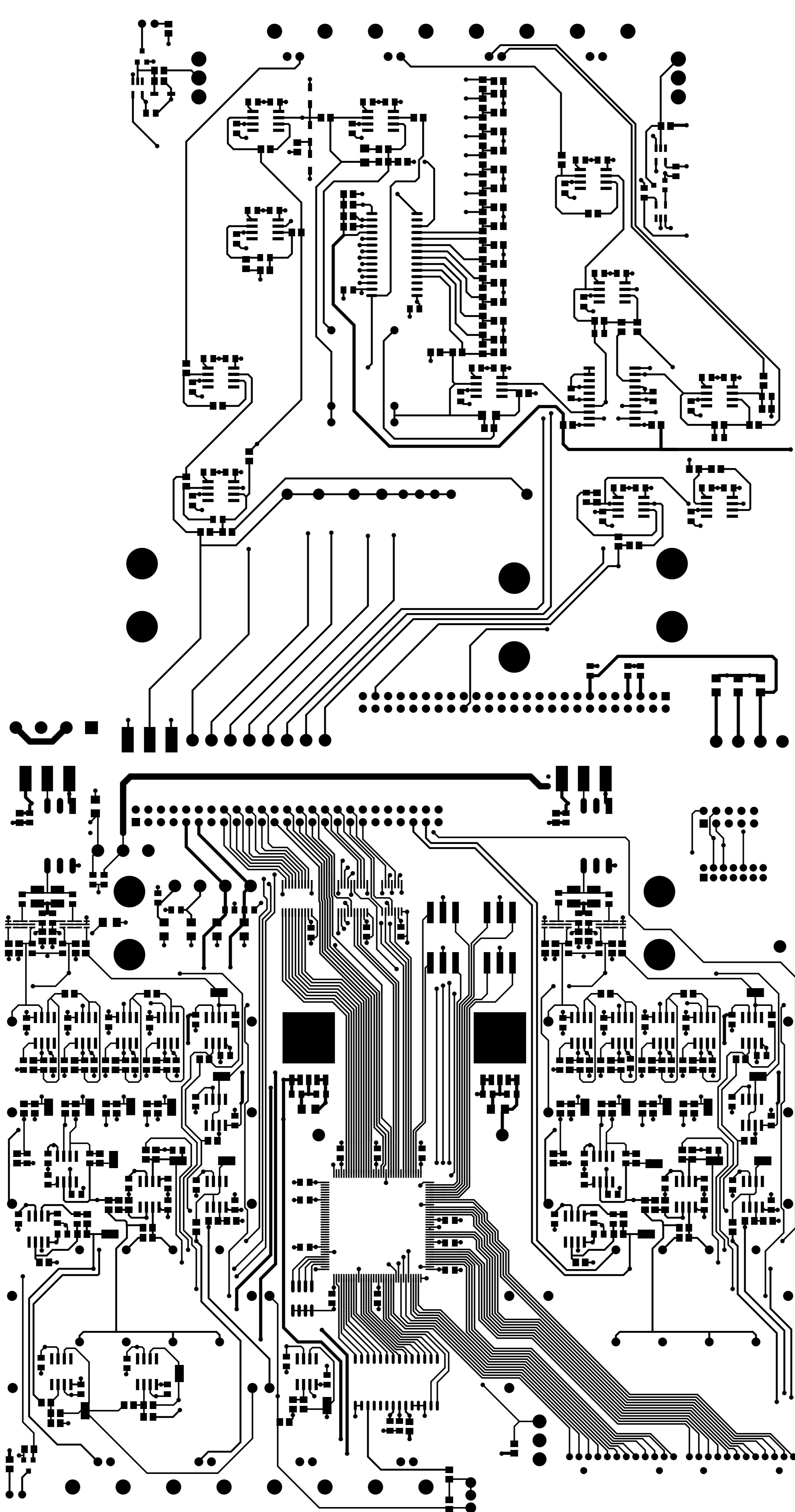

11

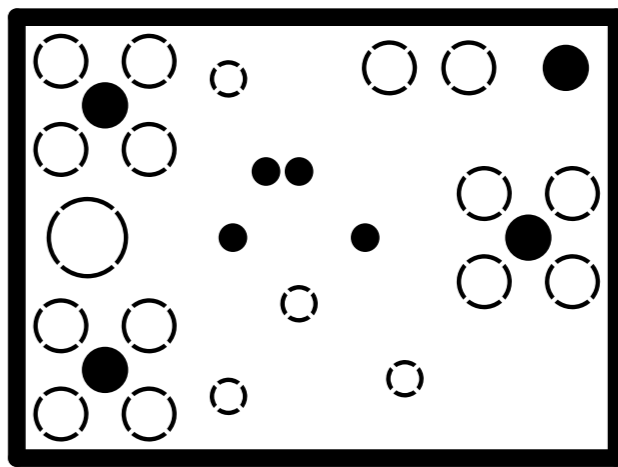
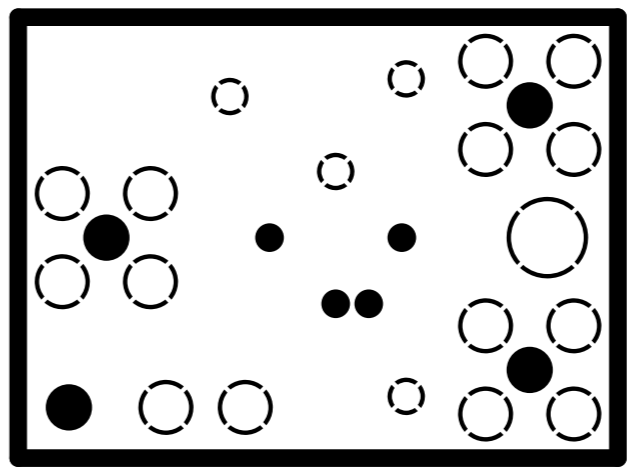
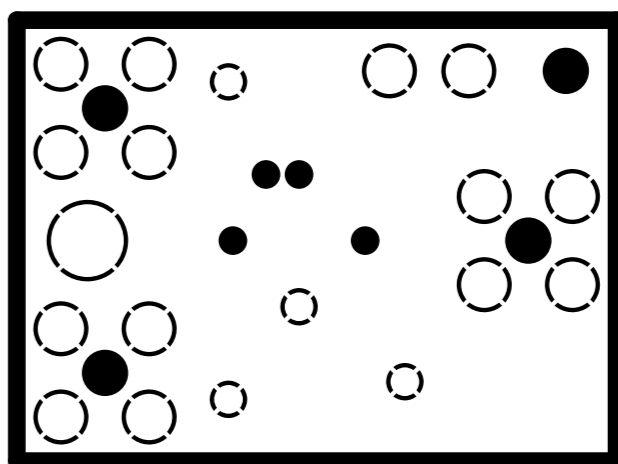
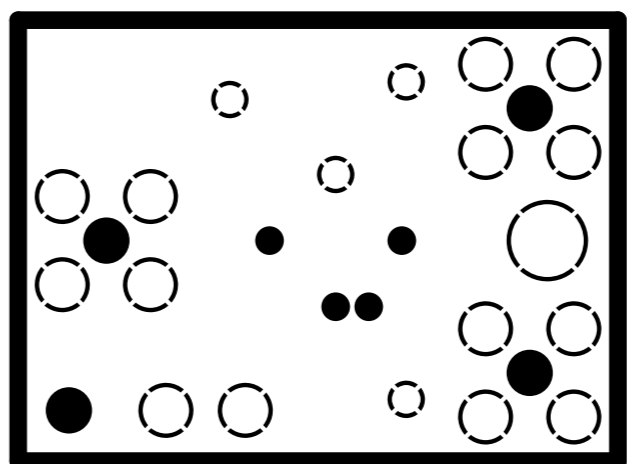
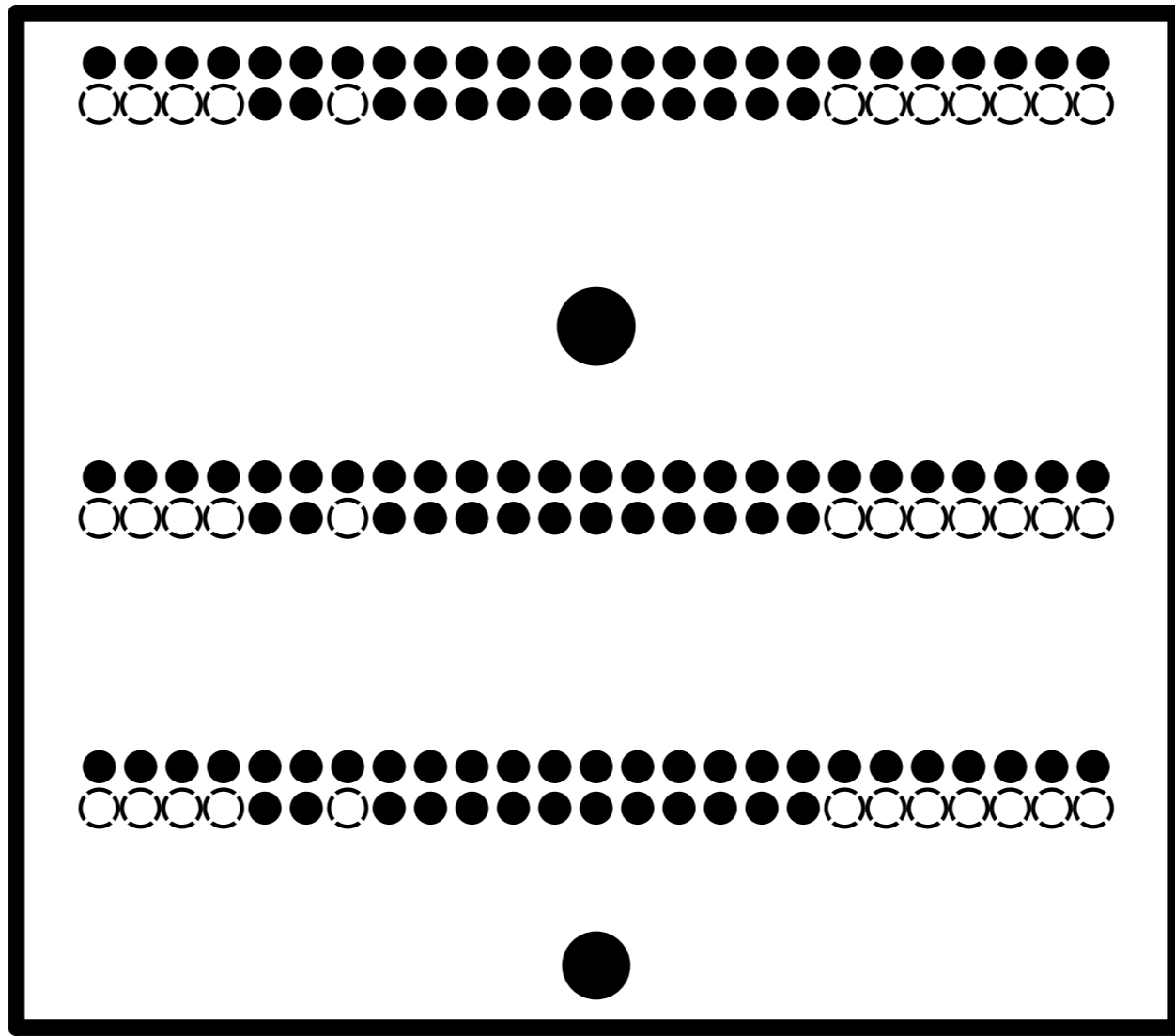
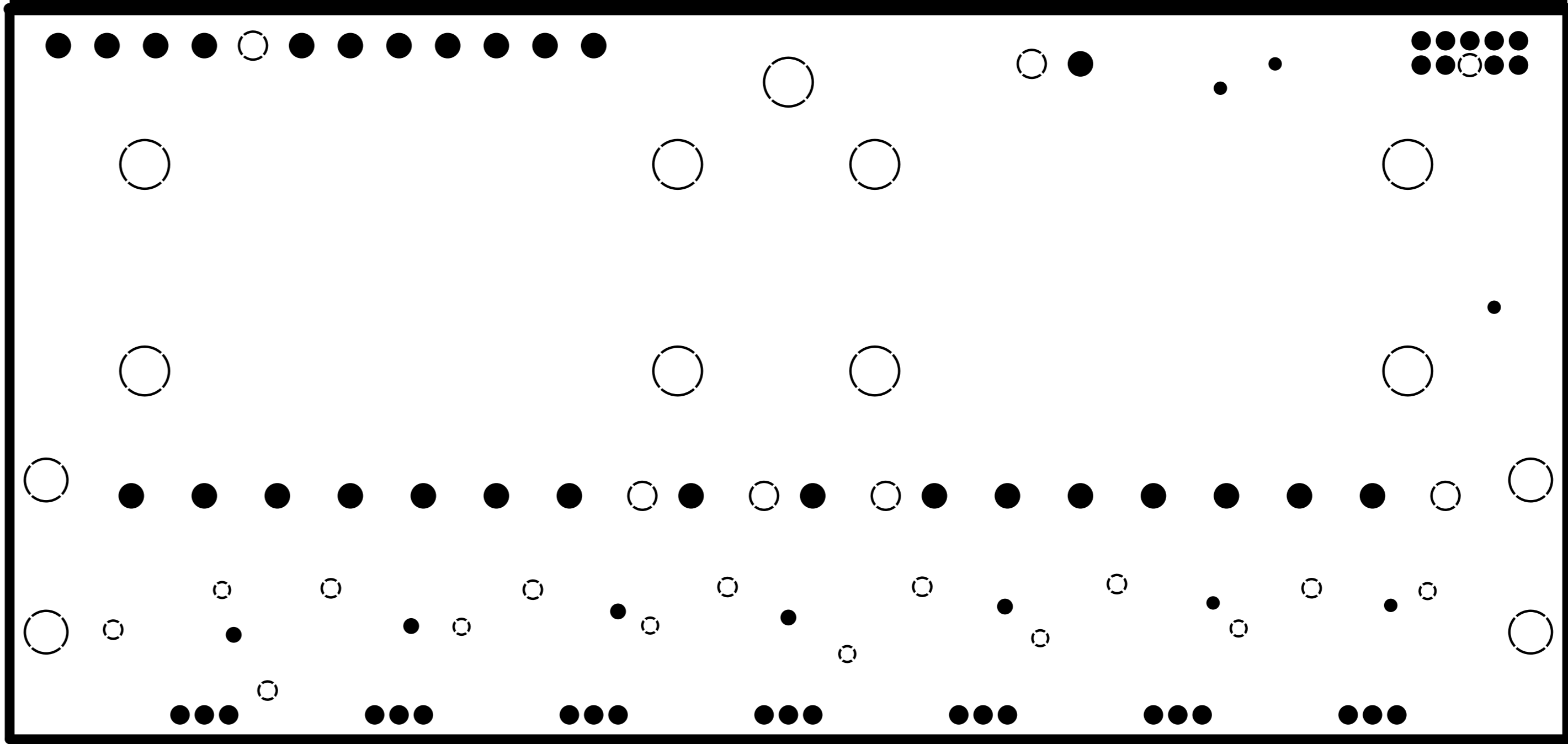
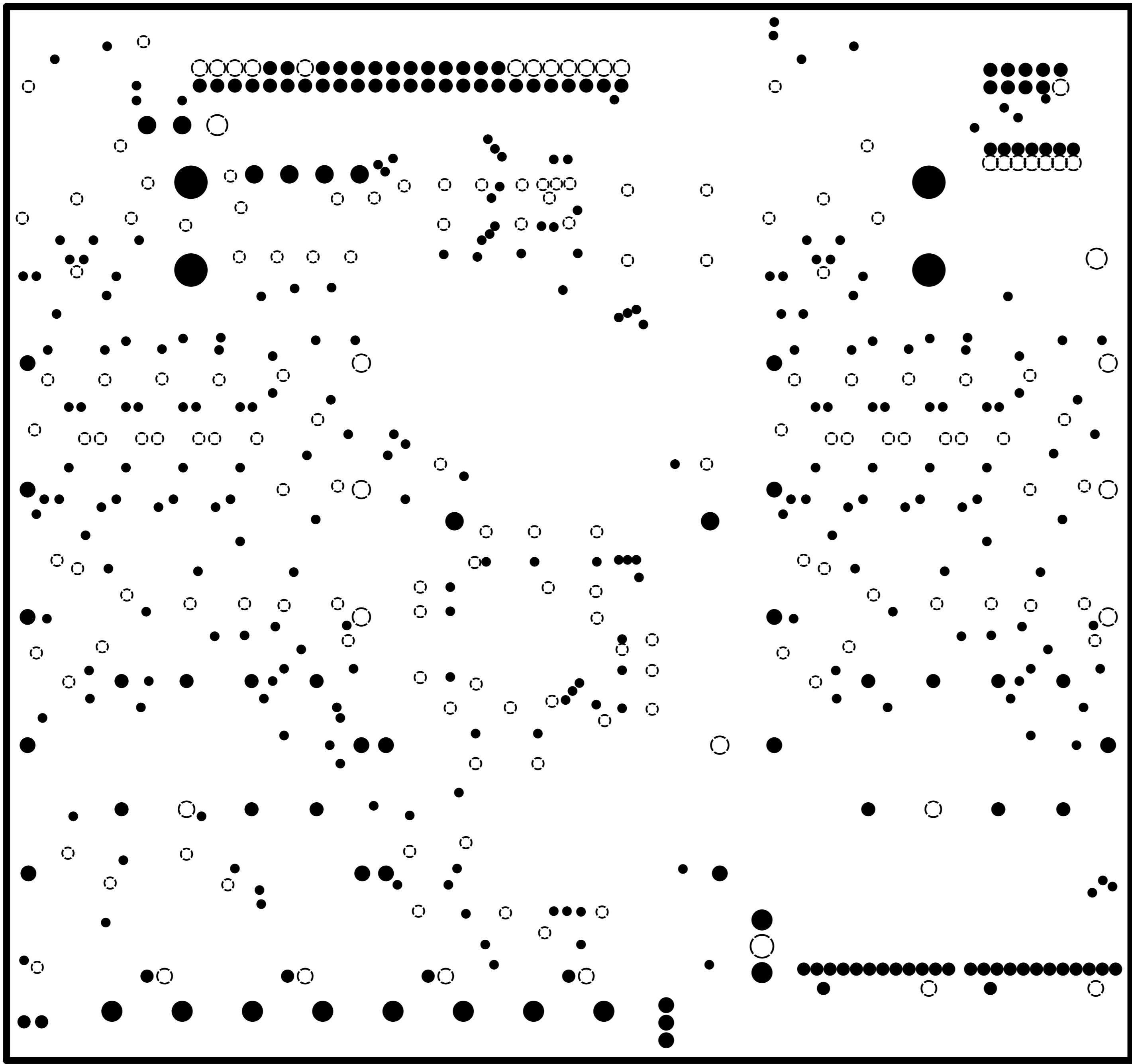
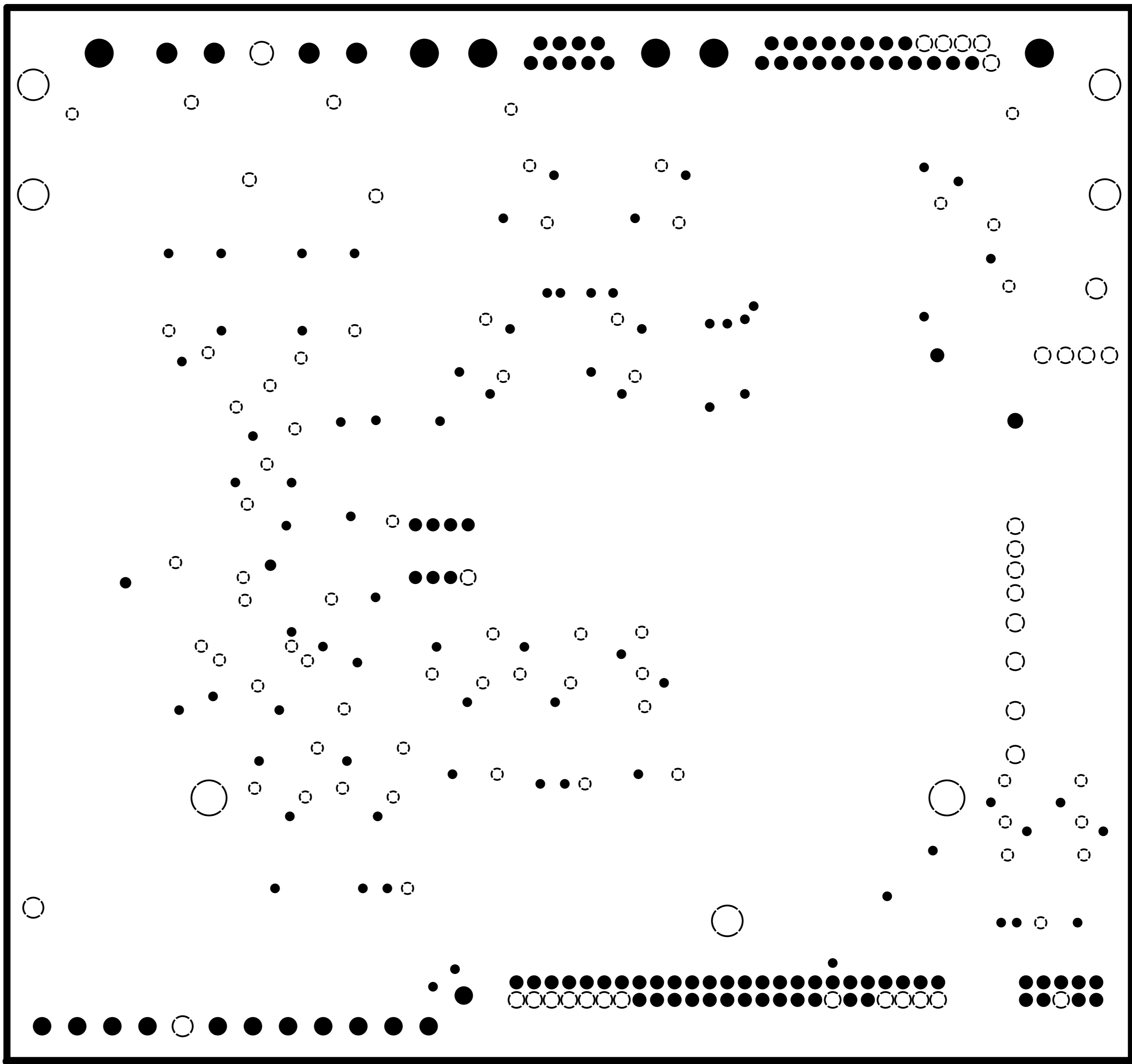
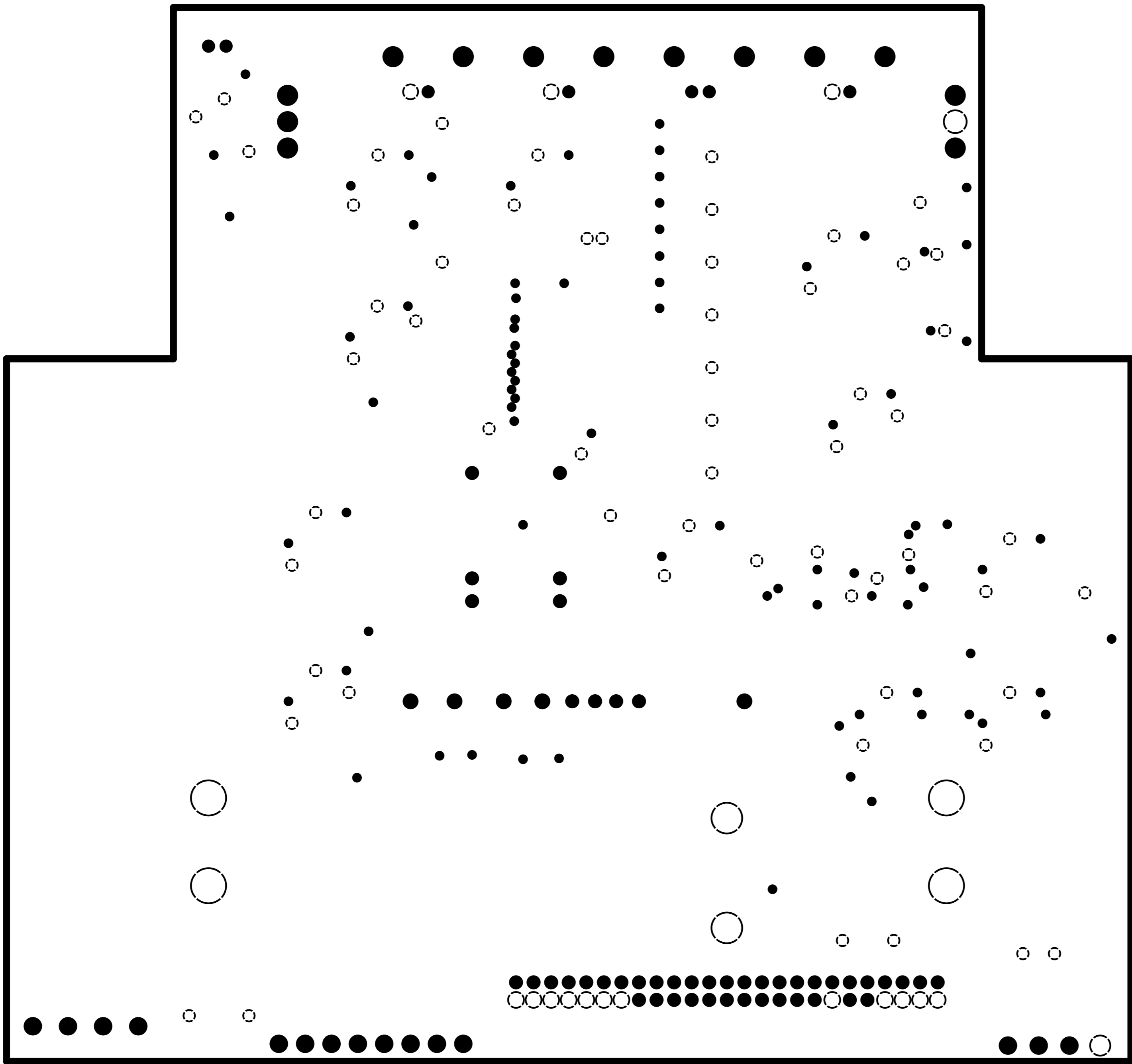

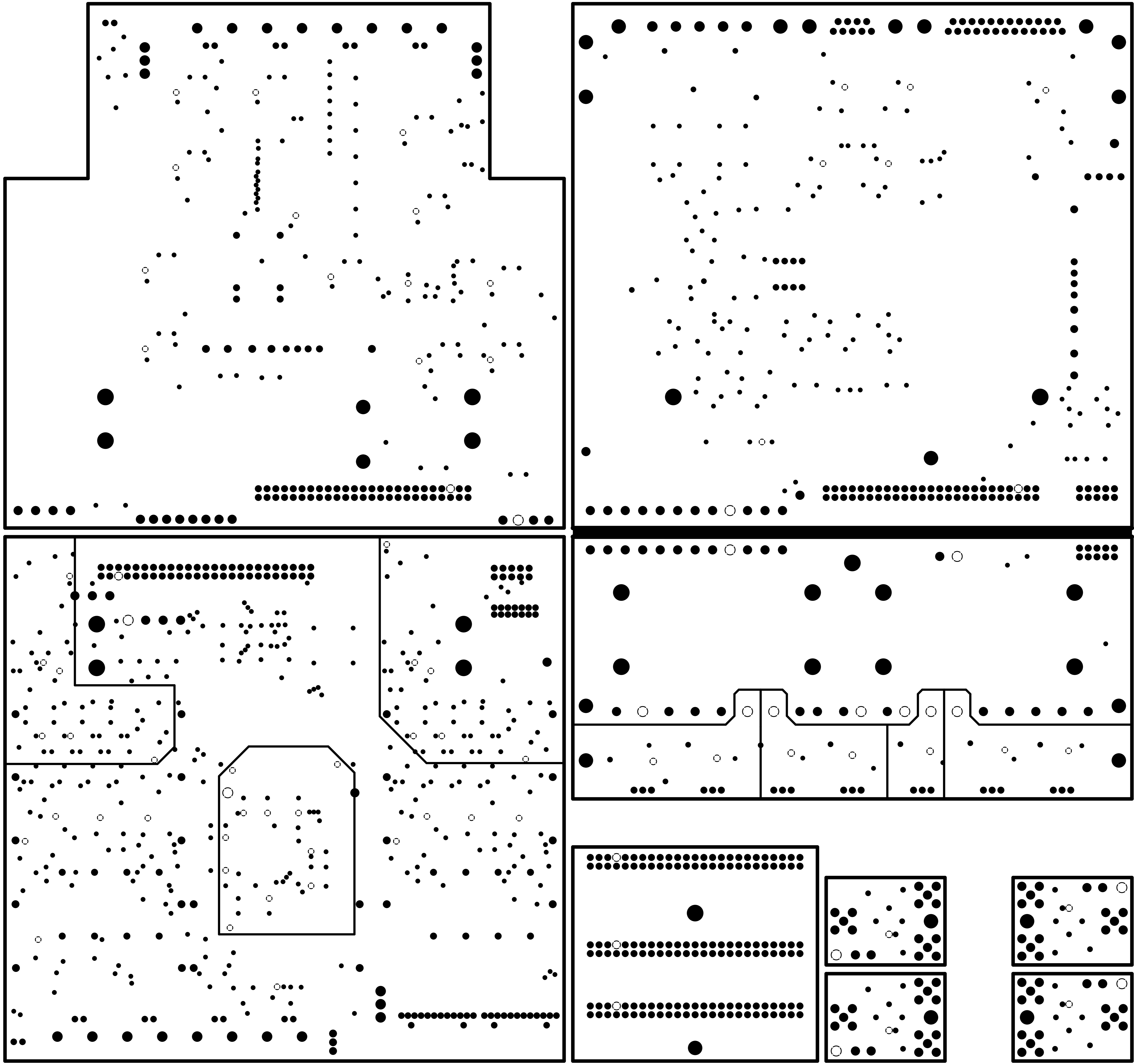

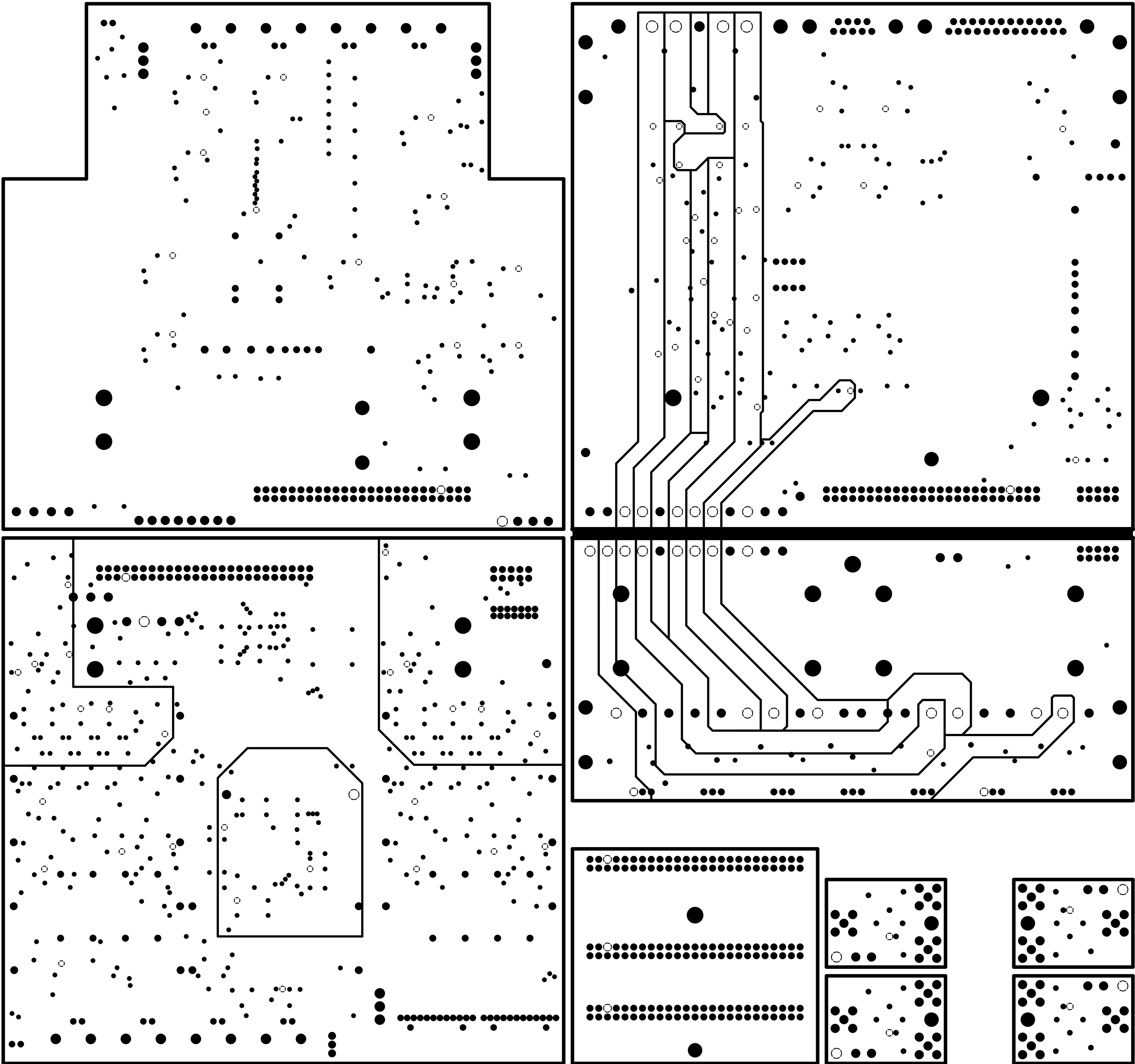

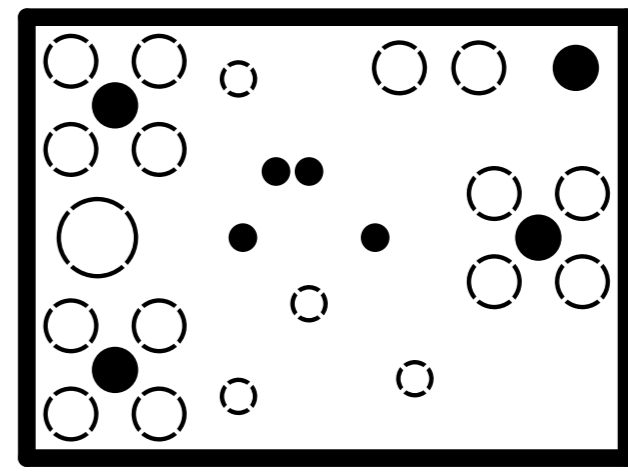
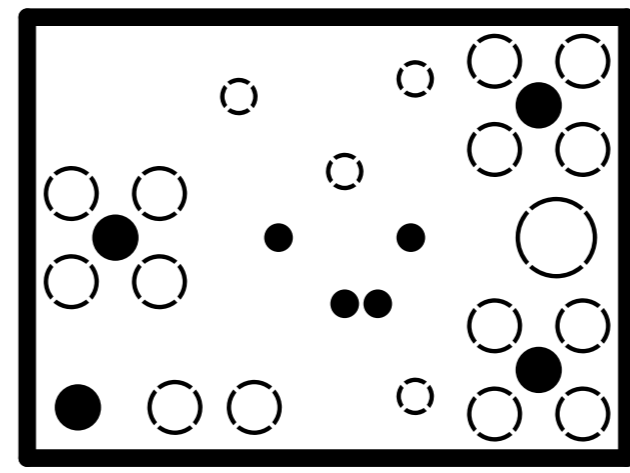
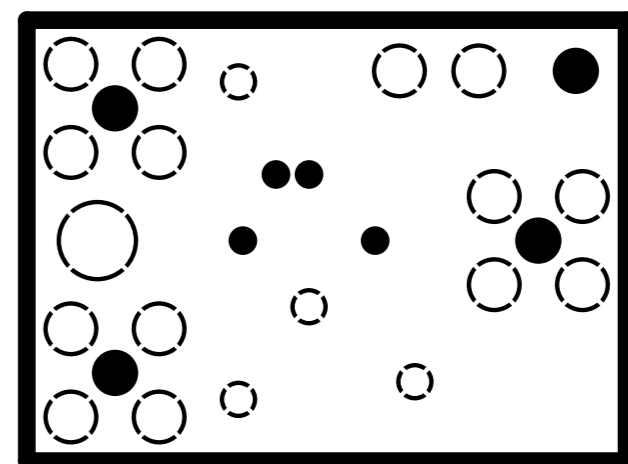
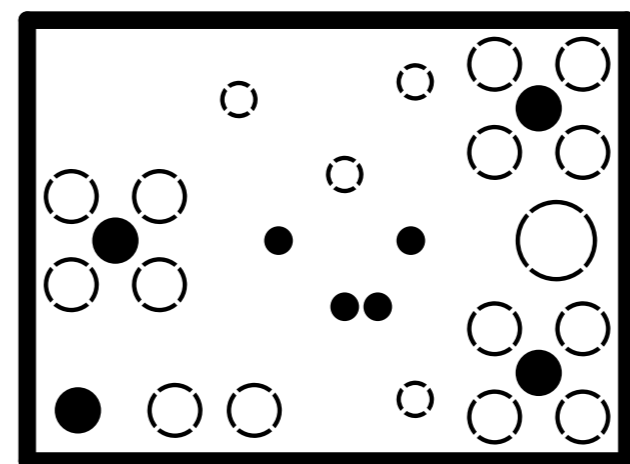
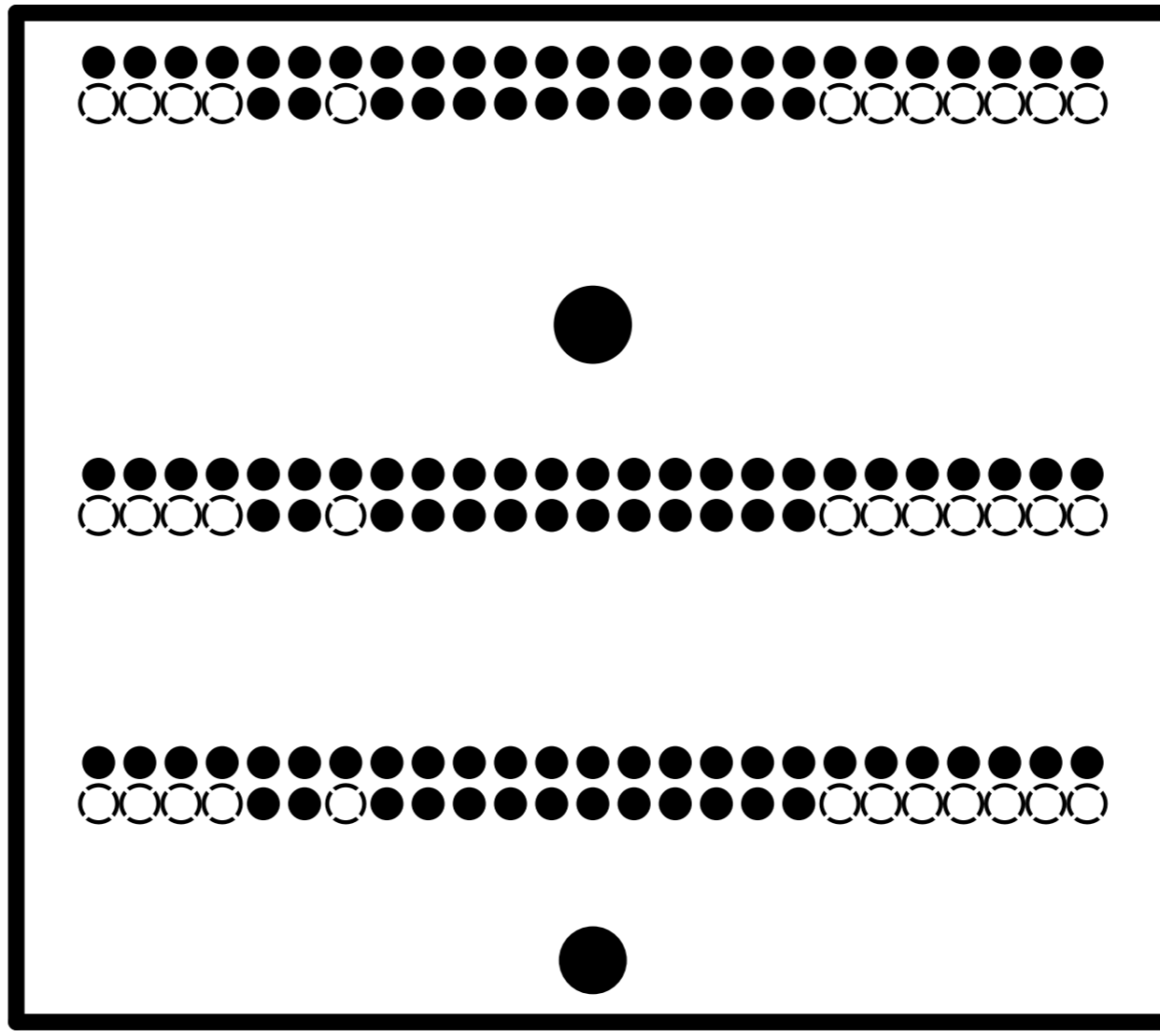
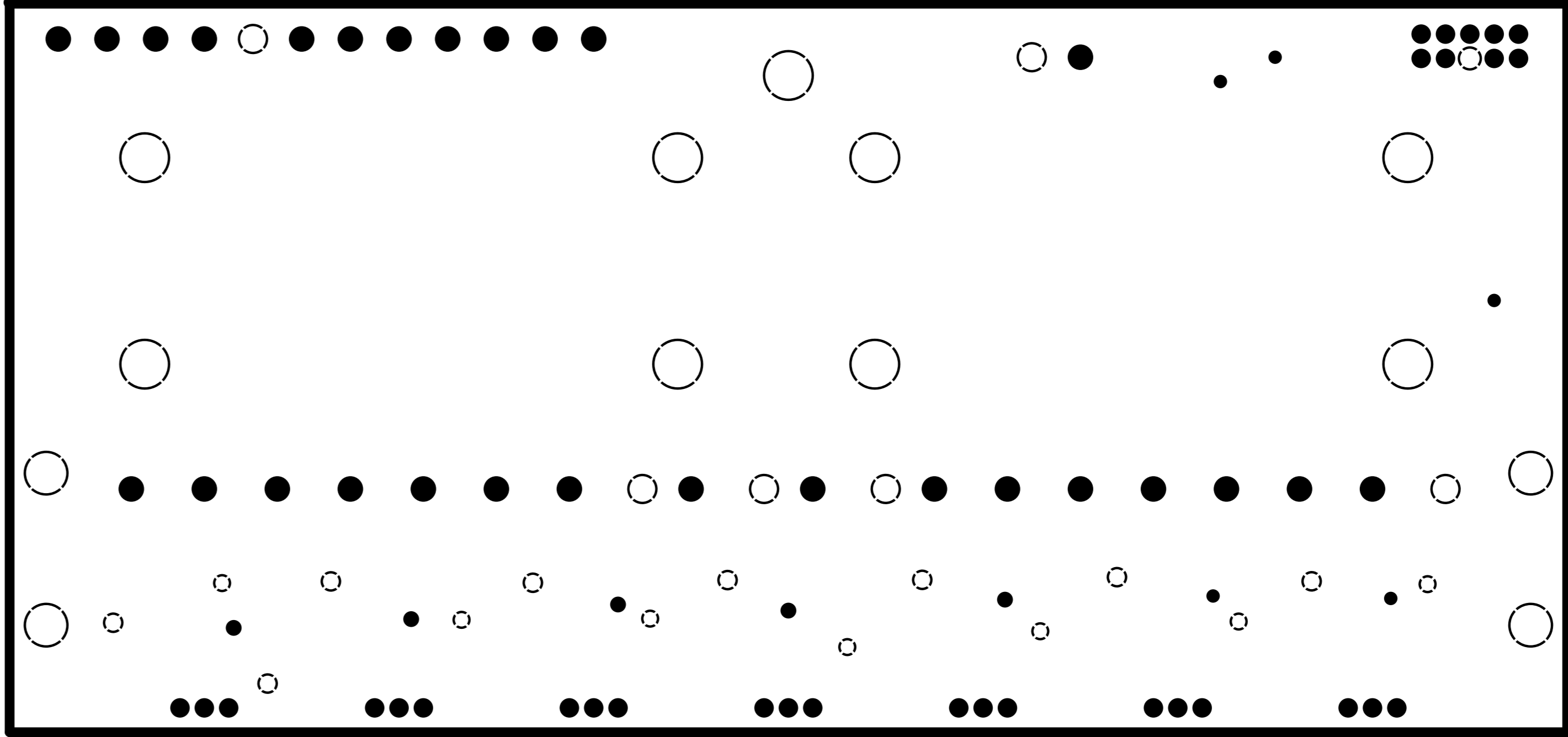
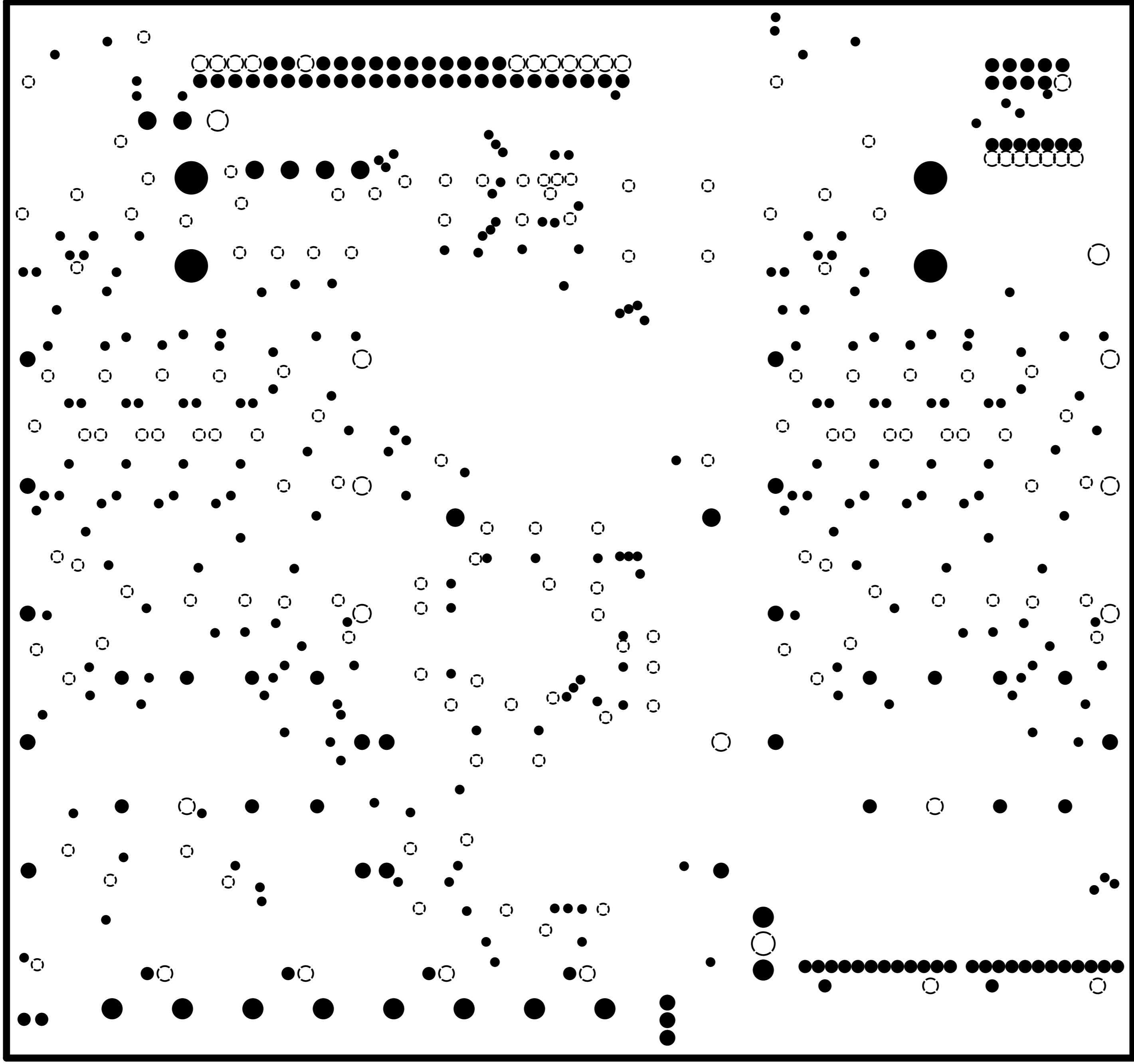
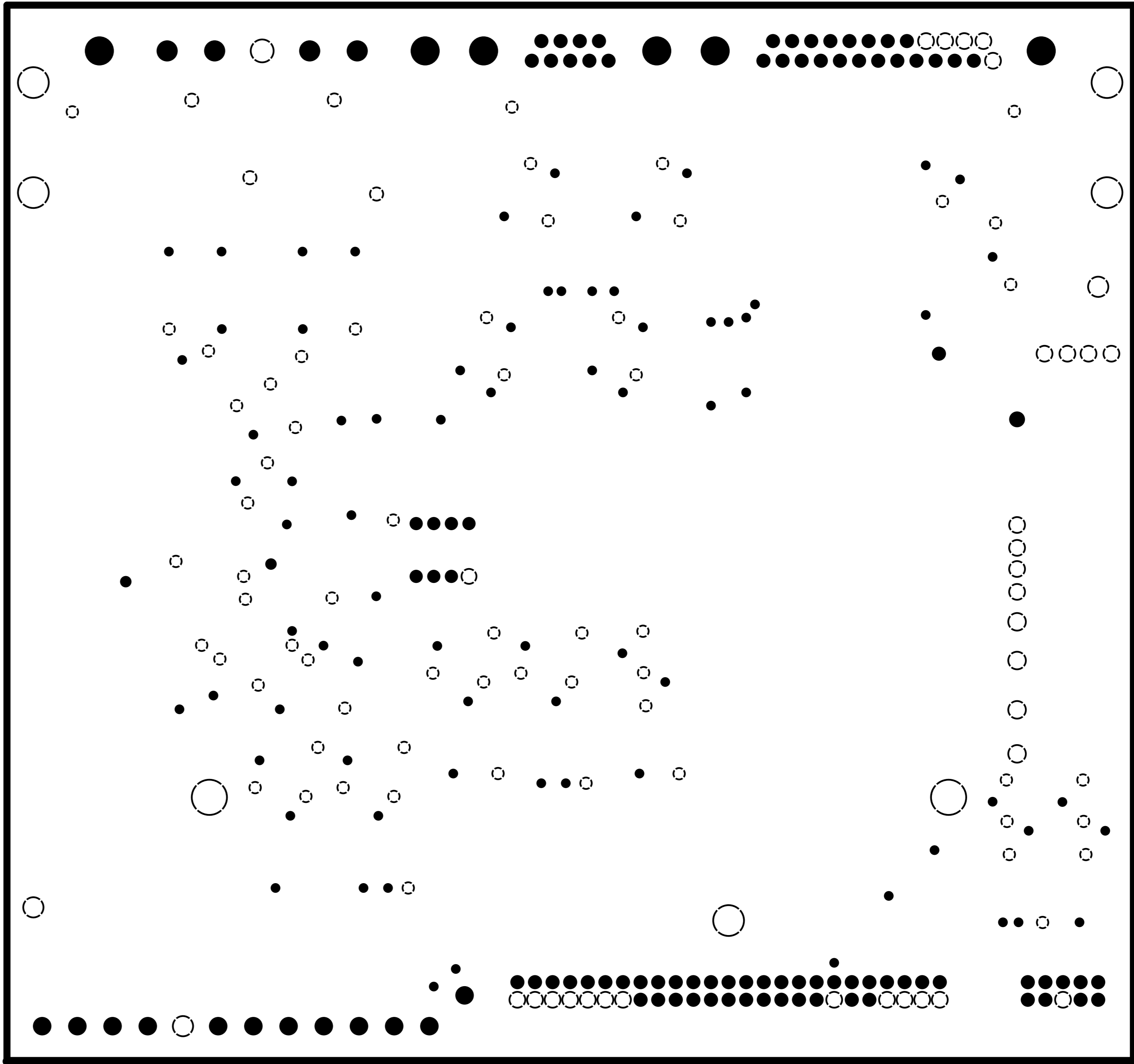
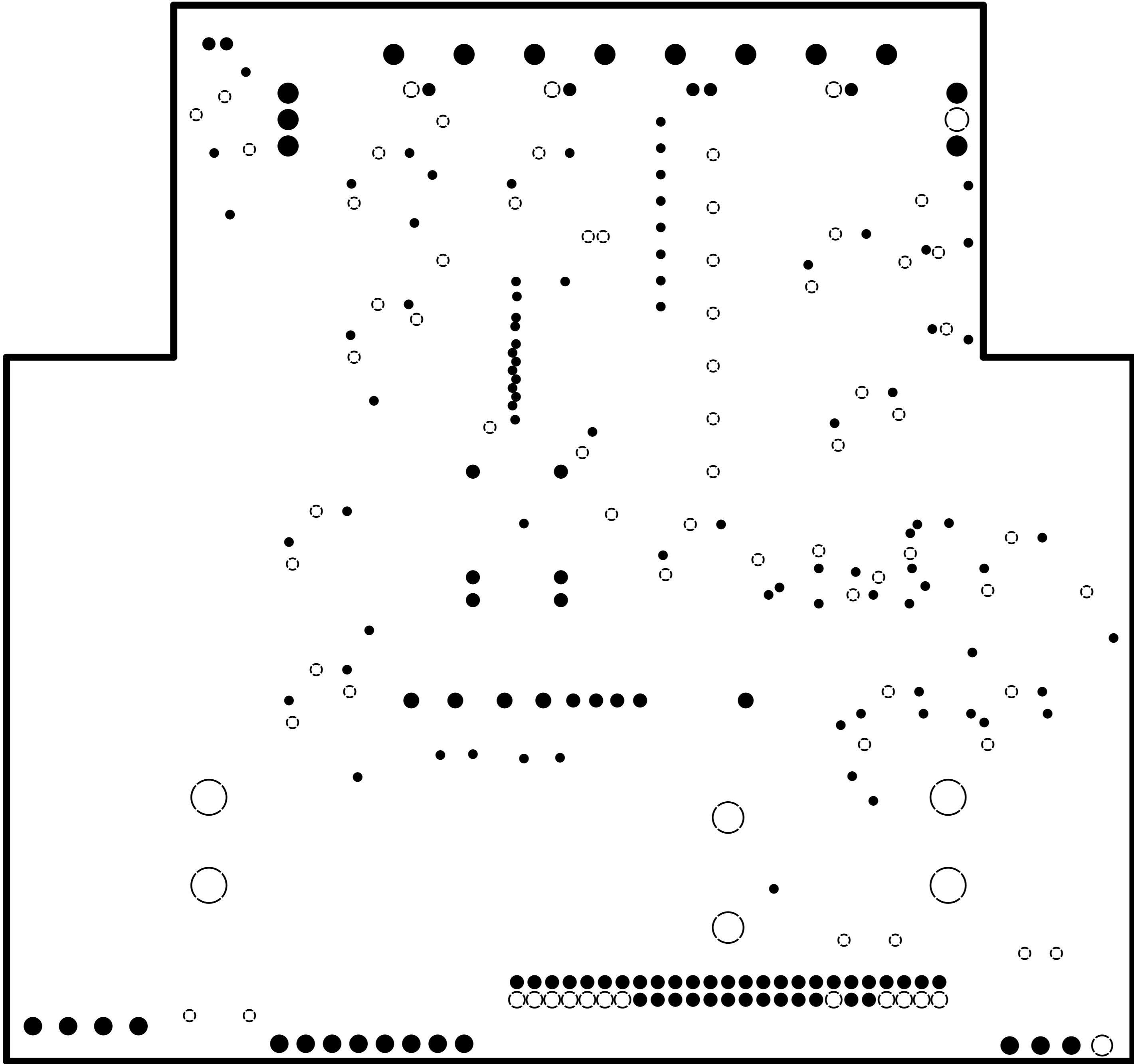

1b

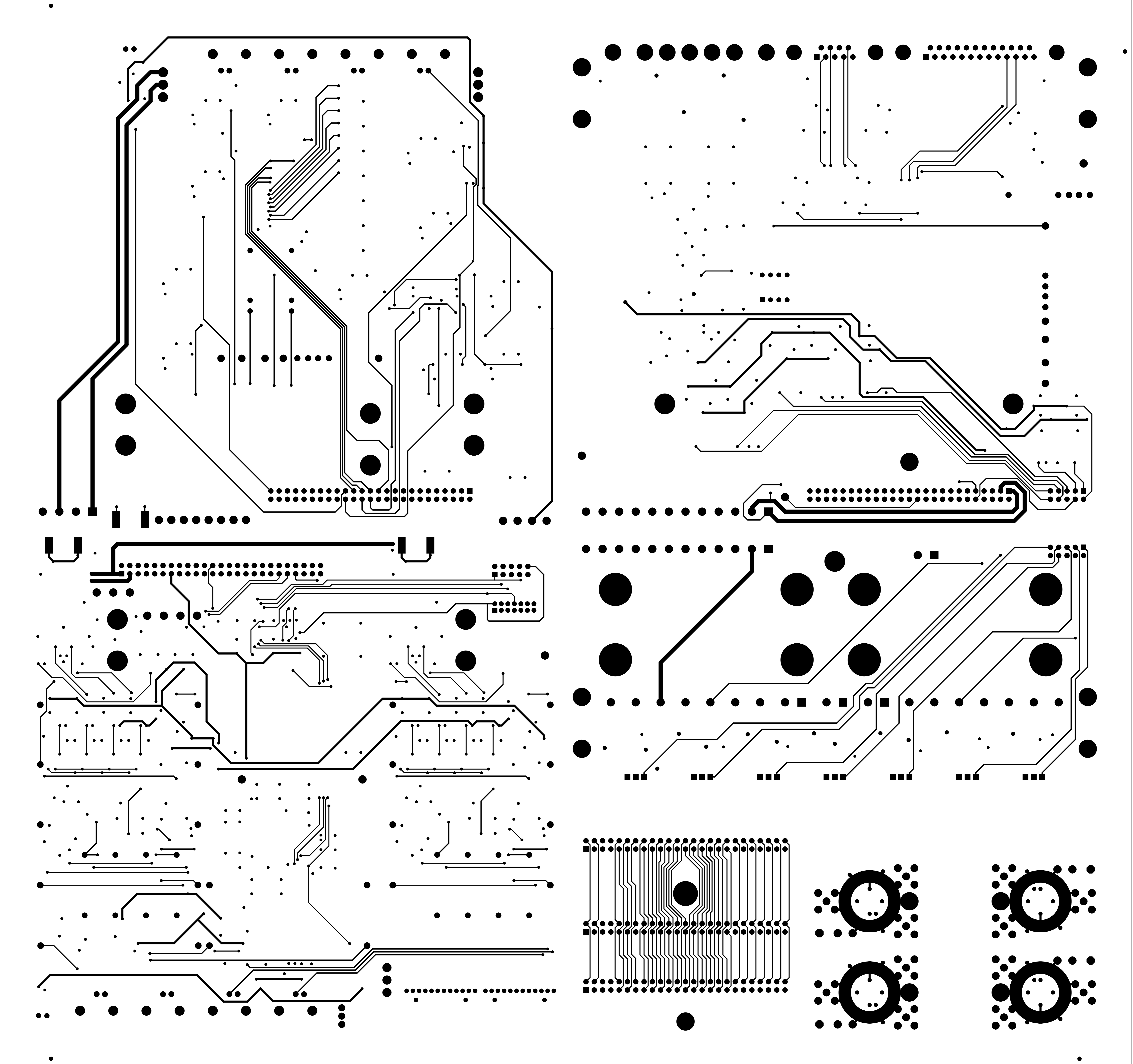

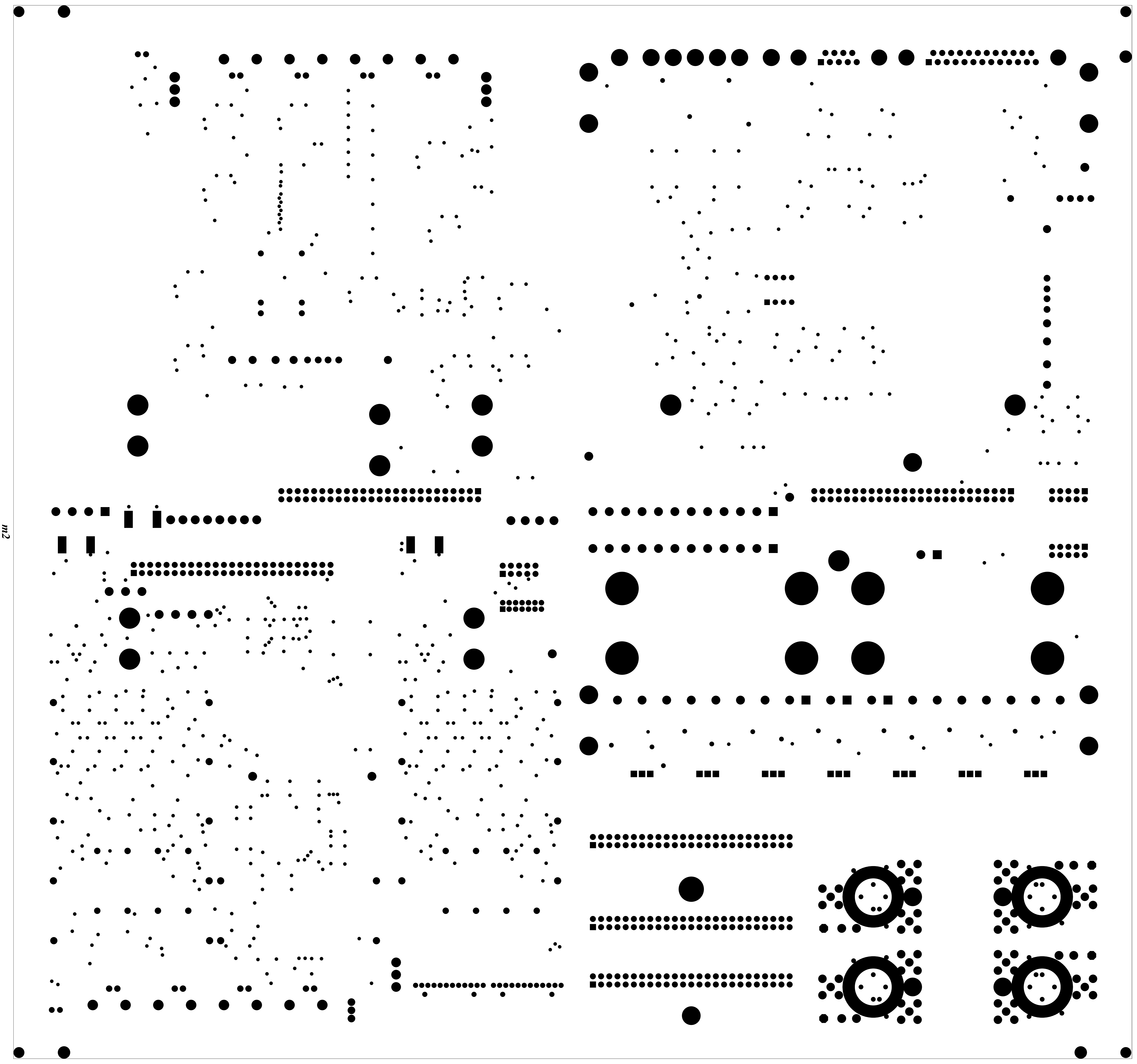

m2

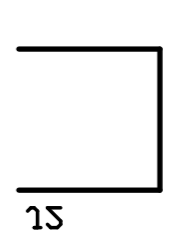
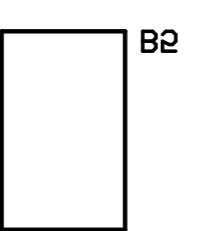

11

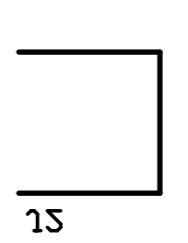

11

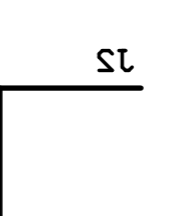

13

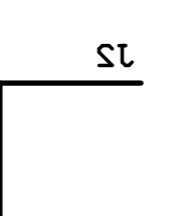

13

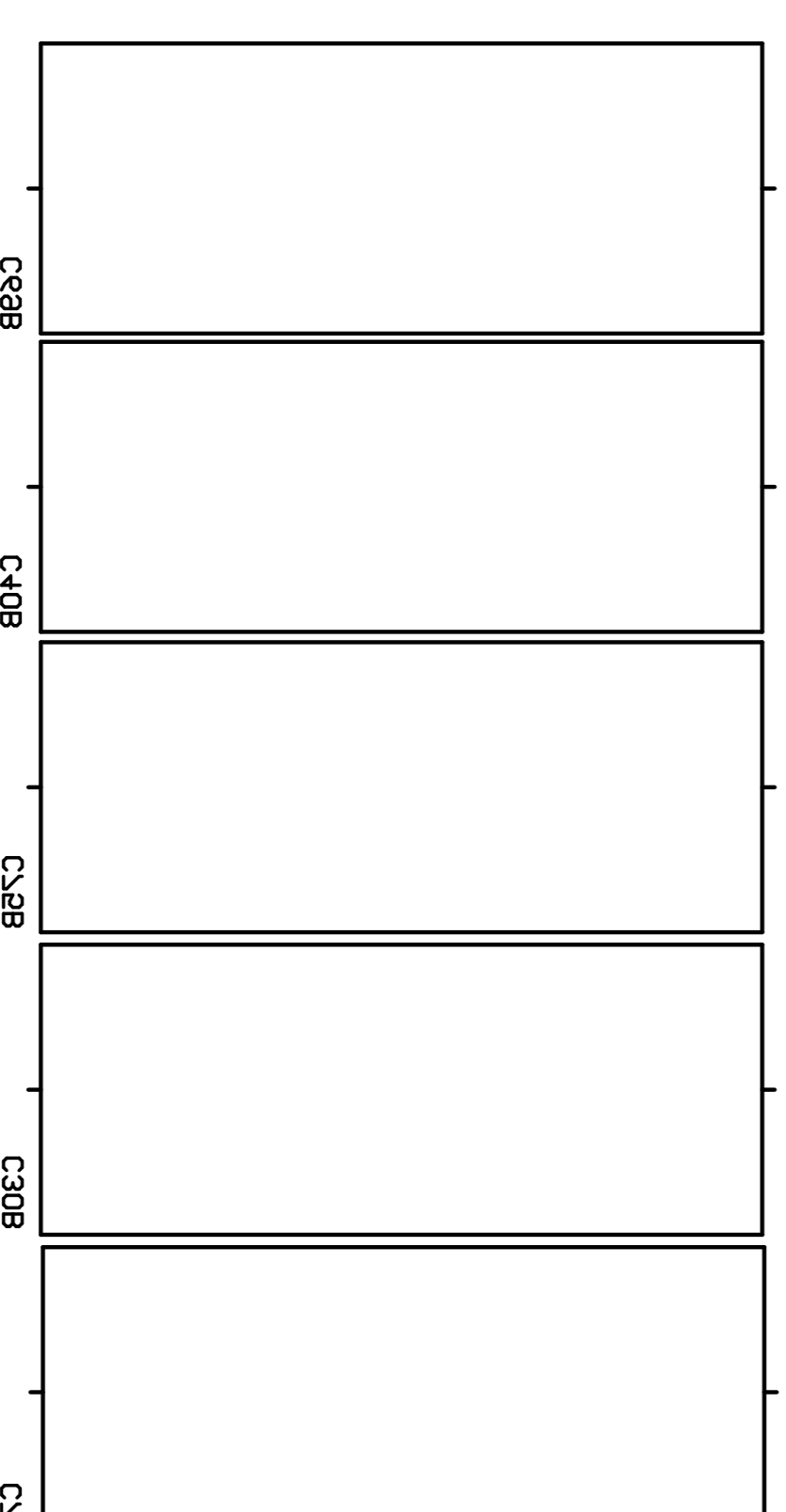
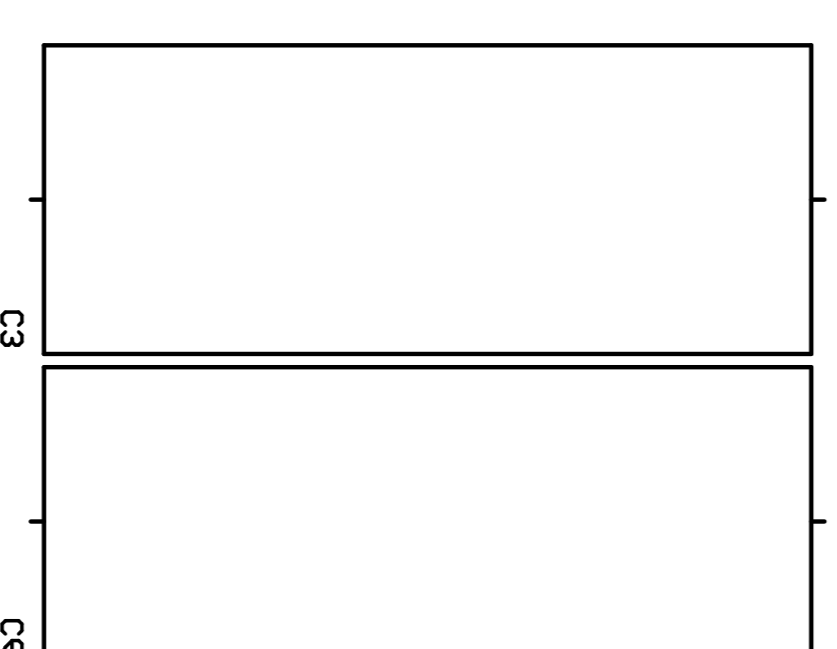
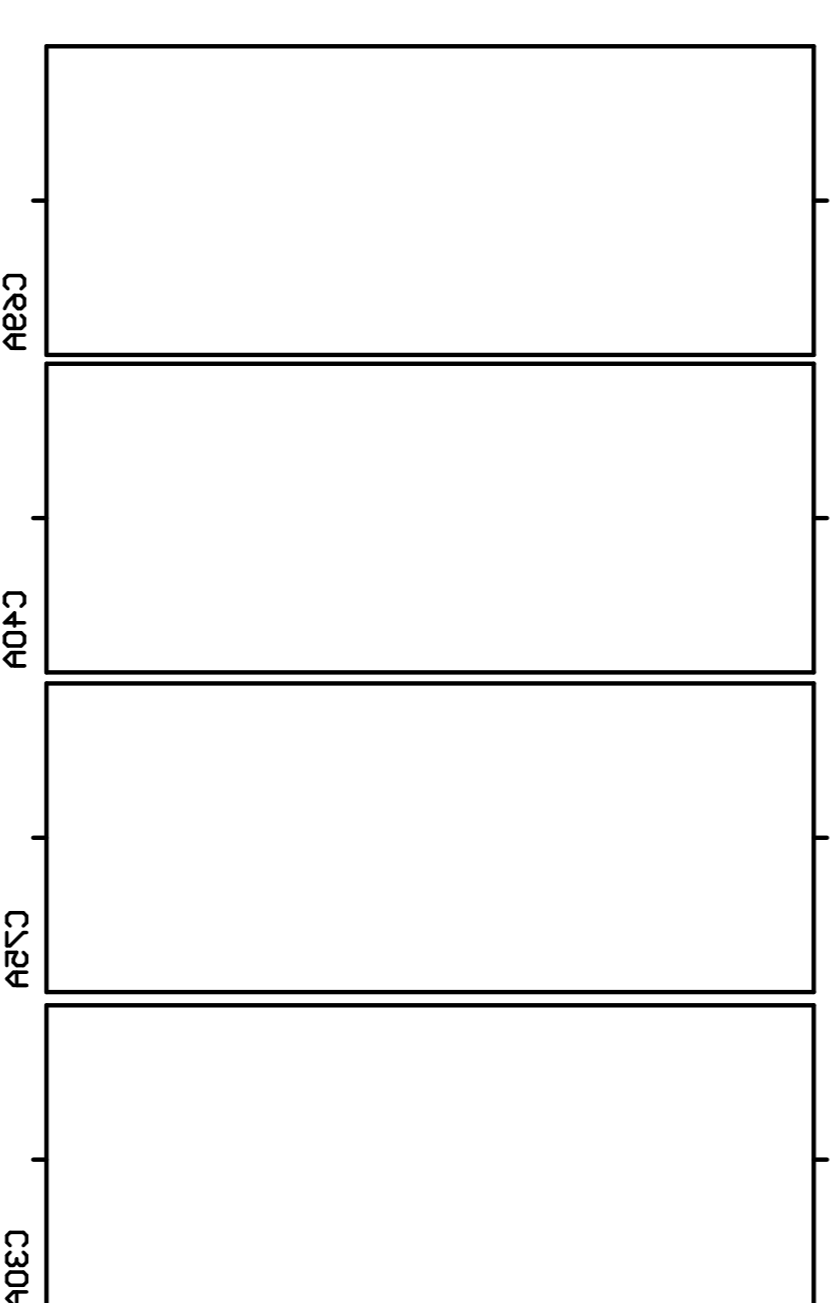

dtp

