

System-wide upgrades to improve the Seismic Isolation and control of detectors beyond A+

Brian Lantz, presenting ideas from the SEI team and beyond
Sept 15, 2020, G2001539

Outline

Seismic noise is not a *Direct* limit for DARM anywhere above 10 Hz, so why should we try to improve the Isolation System?

Stable operation with low noise.

Better Seismic Isolation system could:

- Improve the science by improving the interferometers' up-time
- Improve the science by improving the stability of the interferometers
- Improve the science by reducing noise in DARM.

Today:

- Improve the tilt sensing of the platforms (better absolute motion)
- Integrate the seismic tables with direct platform-to-platform sensors
Seismic Platform Interferometers (SPIs) to
dramatically reduce the relative motion of the tables (~ 10 nm RMS)
- Reduce the motion of the optics below 10 Hz
- Reduce the noise (bandwidth) of the controls on the mirrors.

Work through 1 example (SRCL) to show what's going on.

Implement system-wide for “beyond A+”

Duty cycle

Good source location wants 3 detectors running, but now this is only true about 1/2 of the time.

It's getting better - but we're a long way from "breaker-to-breaker"

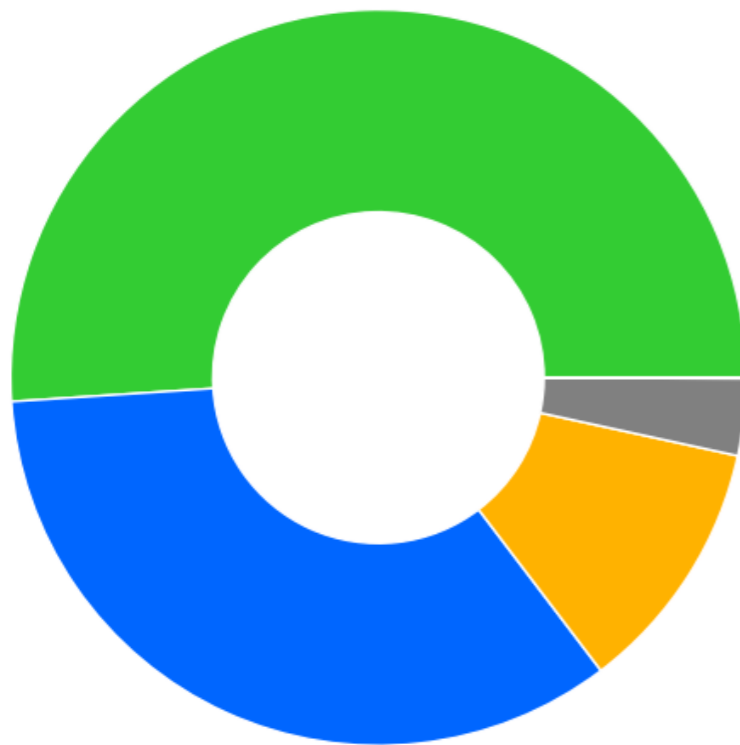

Network duty factor

[1256655618-1269363618]

- Triple interferometer [51.0%]
- Double interferometer [34.3%]
- Single interferometer [11.2%]
- No interferometer [3.4%]

Obs. Time	O3a	O3b
Triple	44.5%	51.0%
LHO	71.2%	78.8%
LLO	75.8%	78.6%
Virgo	76.3%	75.6%

<https://ldas-jobs.ligo.caltech.edu/~detchar/summary/O3a/>

Duty cycle

Unusually large seismic activity is the largest source of “known” lock-losses (LLO data).

Large motions range across the low frequency bands (wind, EQs typically < 100 mHz, microseism is ~150 - 300 mHz, anthropogenic is a few hertz.)

Count of classification

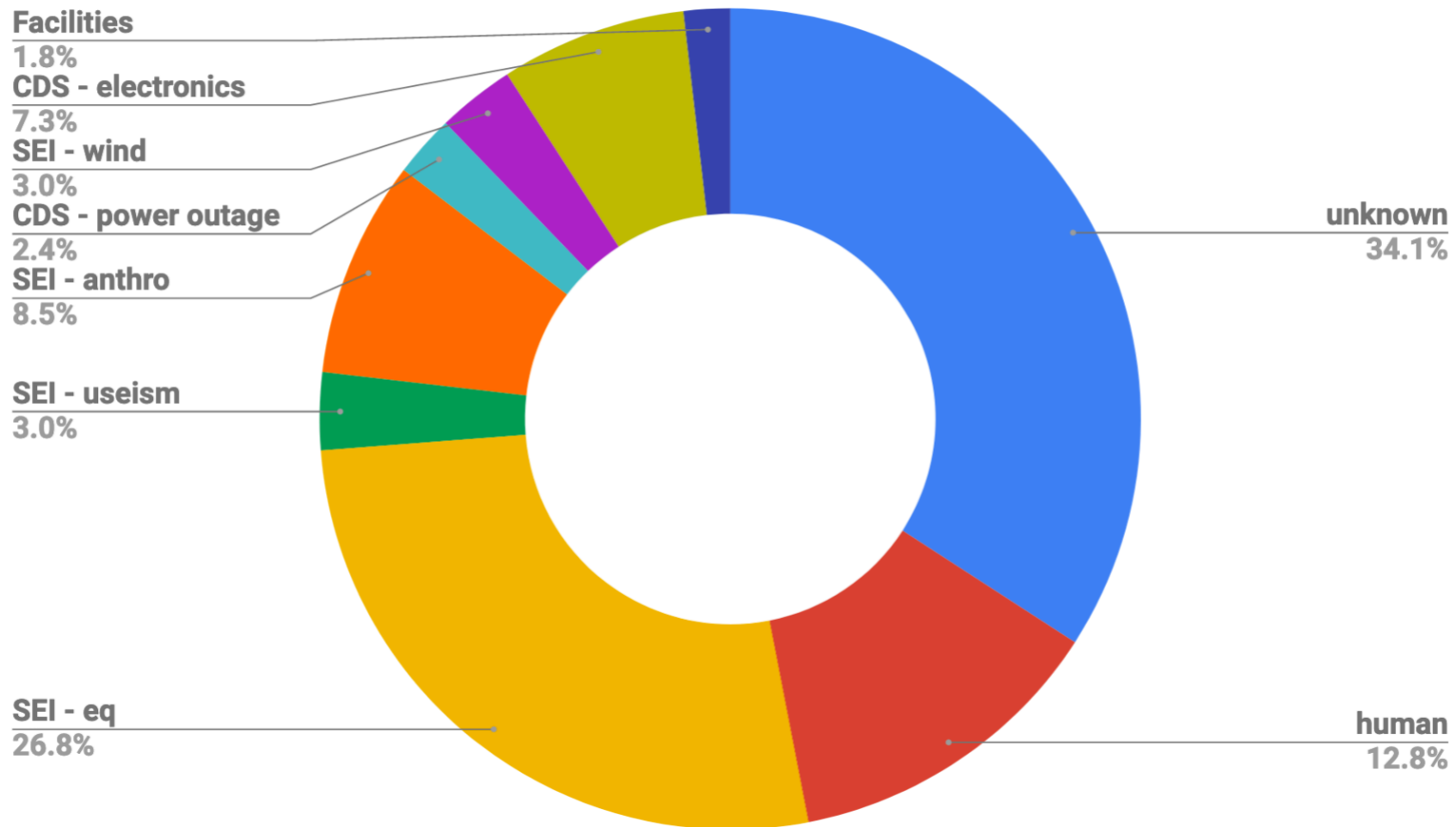

Relative motion between optics causes glitches

Scattering arches from relative motion between ETM and the transmon telescope (not fixed by R0 tracking)

(11 March, 2020, Corey, Anamaria, Gaby, Sidd)

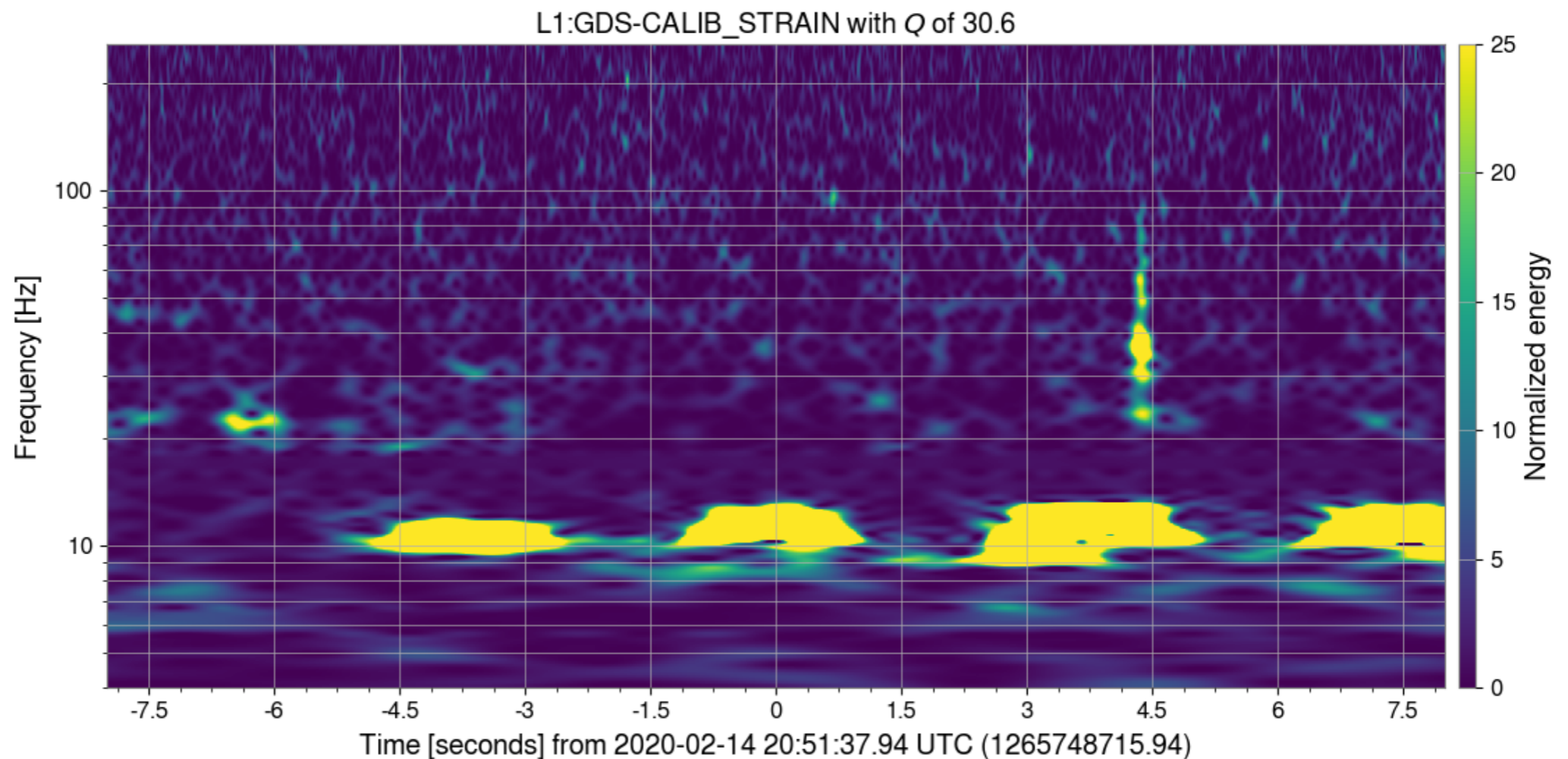

Microseism causes glitches

Microseismic BLRMS at LHO:

We use the same technique here with scattered light glitches as the previous results to compare our findings with the microseismic BLRMS channels at both the end and corner stations. Again, for the histograms, each bin was individually normalized by the number of minutes throughout O3a (or O3b) in which the trend amplitude was greater than or equal to the lower limit of that bin.

Scattering glitch rate vs. microseism at the scattering glitch time **Katie Rink, LHO log 56080**

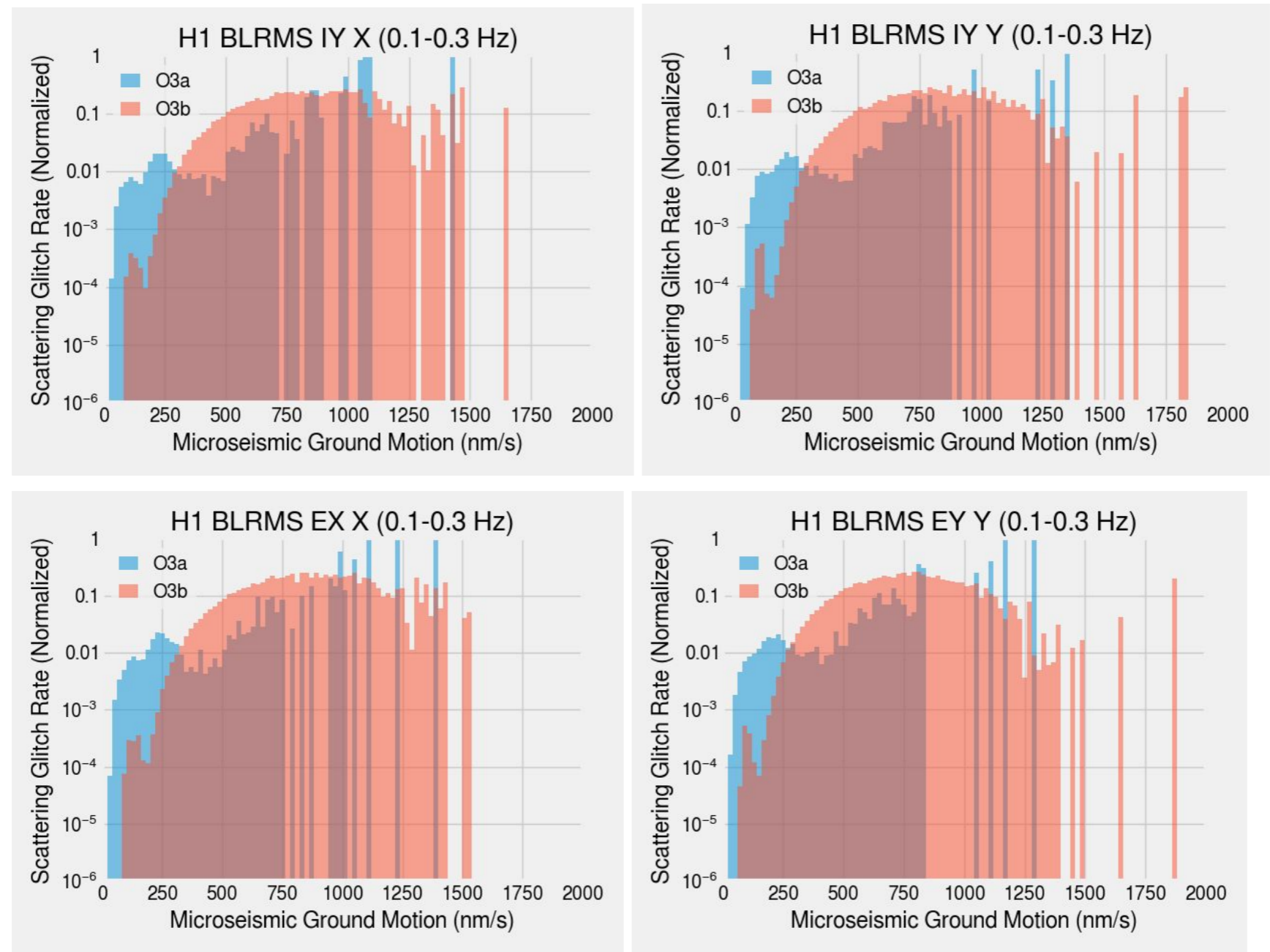

This is not a system

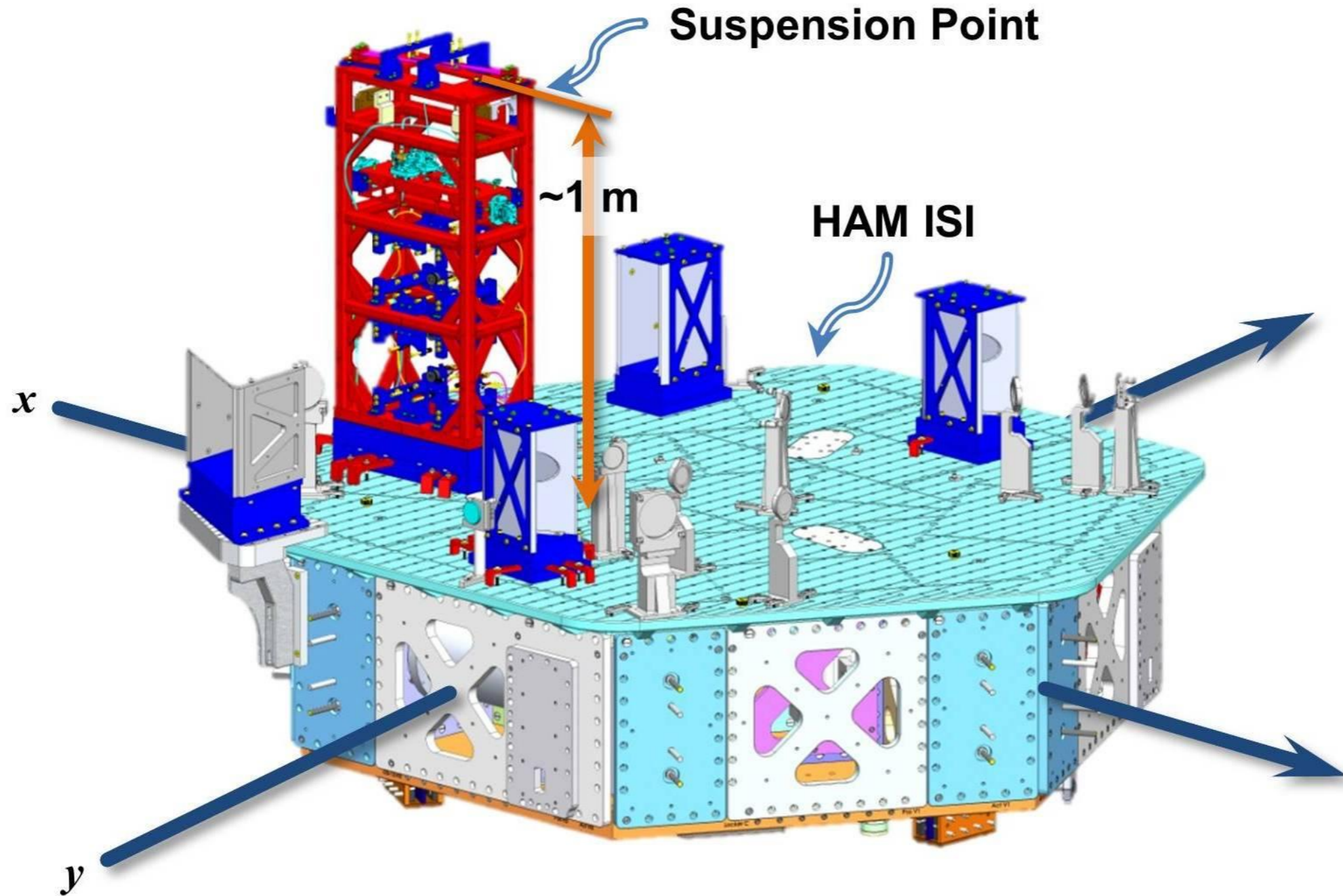

This is (most of) a system

Purpose of the system is to minimize stray forces on, and relative motion between, all these optics.

Tables and suspensions provide isolation from ground motion. Residual differential motion between optics is controlled by pushing on the optics (ISC)

This is (most of) a system

Purpose of the system is to minimize stray forces on, and relative motion between, all these optics.

- cBRS at BS to lower tilt
- 1 new LF seismometer per HAM to reduce vertical motion
- SPIs between tables to reduce relative translation (integrated with opt. lev.)
- optical levers between tables for tilt.
- lower noise OSEMs
- (another talk - reduce BW of HARD loops)

Residual differential motion between optics is controlled by pushing on the optics (ISC) Better control of difference between tables means less control is necessary at the optic.

Control noise dominates the 'known' noise below 50 Hz

LHO O3 noise budget, S. Dwyer LHO [log 55755](#)

Noise budget for GPS start time: 1268679618, duration: 600s

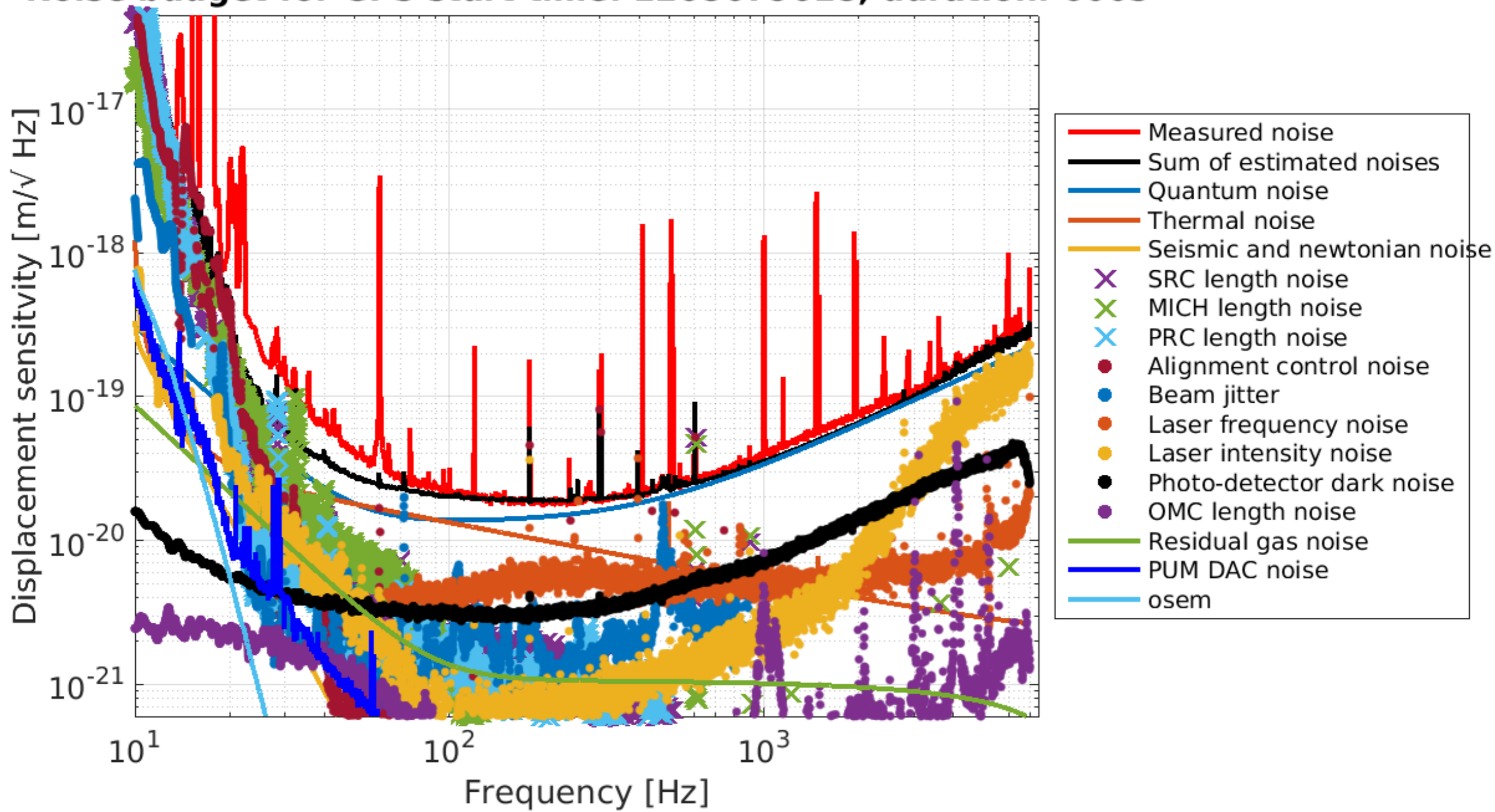

LSC noise contributions to DARM

dominated by PRCL
and SRCL

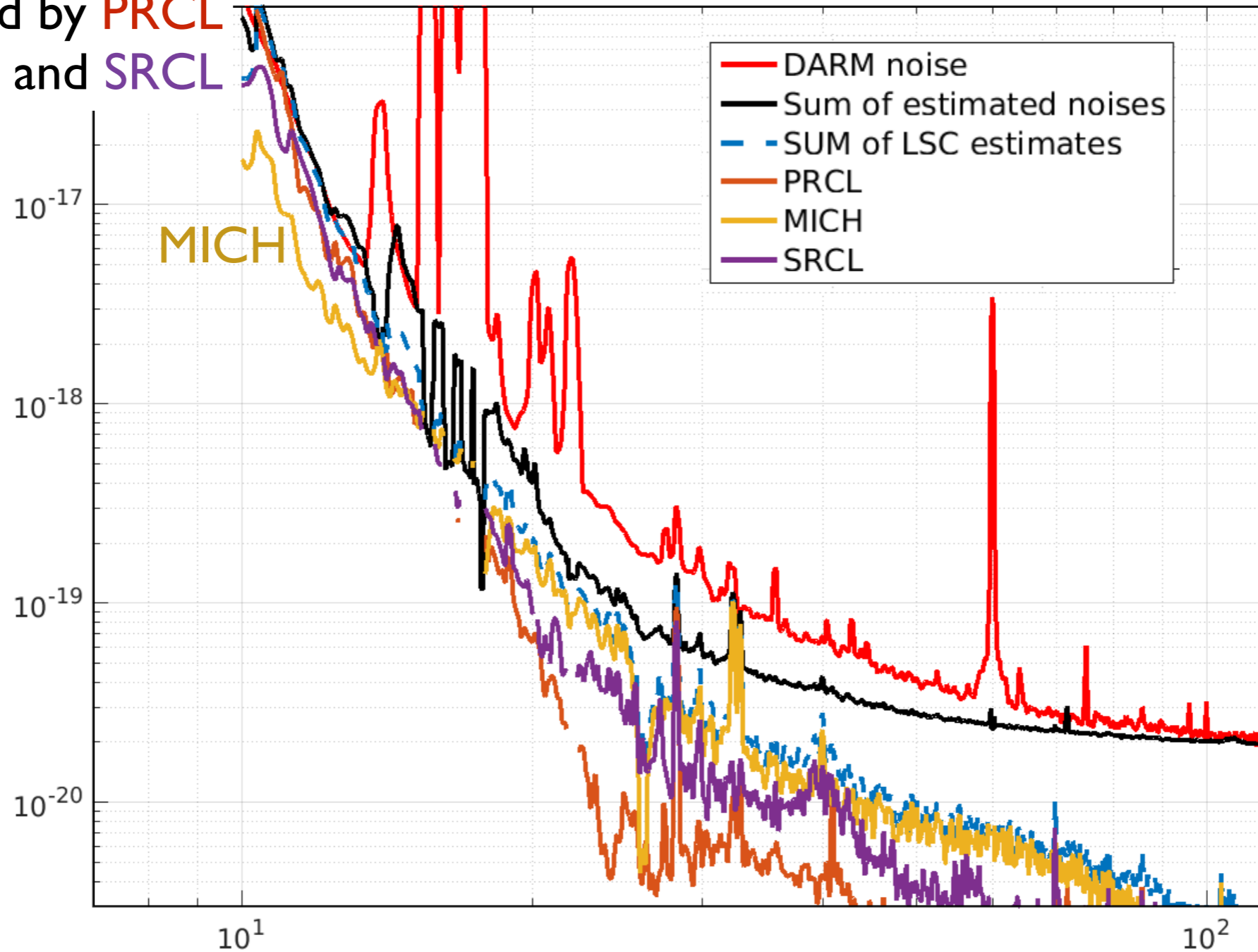

Excess noise and DARM

LLO has best range now.

Excess noise reduces detection volume by $(132.5/166.4)^3 = 0.505$

LLO noise budget, 03 March 2020
 adapted from LLO log 51967

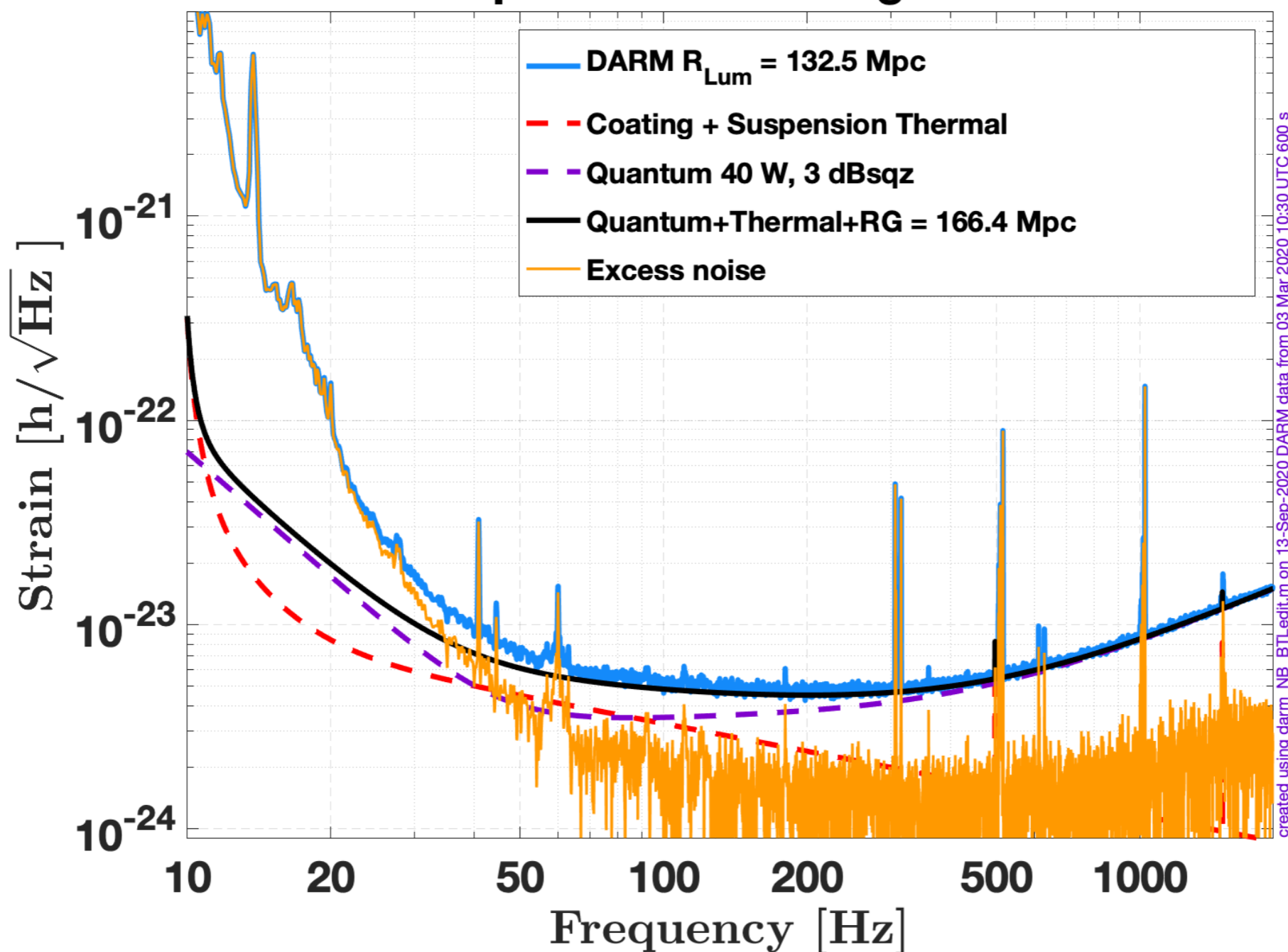

Impacts A+ as well

A+ noise curve, including current excess noise

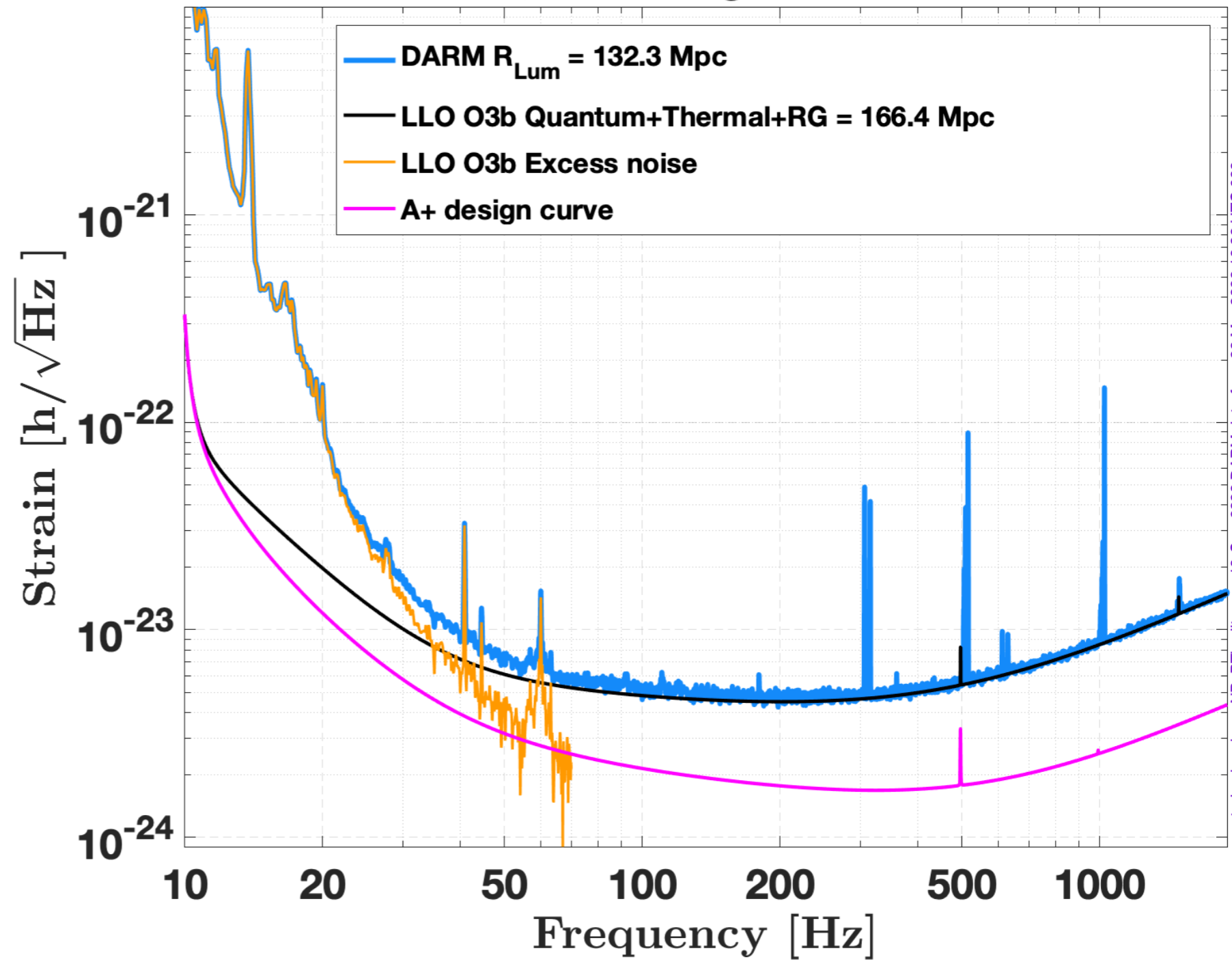

created using darm_NB_BTLejit.m on 13-Sep-2020 DARM data from 03 Mar 2020 10:30 UTC 600 s

Nominal Co-moving Range for A+ is:

- NSNS: 325 MPc
- 30/30 BBH: 2563 MPc
- 85/66 BBH: 3232 MPc

Co-moving Range for A+ with excess LF is:

- NSNS: 265 MPc
- 30/30 BBH: 2178 MPc
- 85/66 BBH: 2378 MPc

Co-moving Volume ratio is:

- NSNS: 0.543
- 30/30 BBH: 0.614
- 85/66 BBH: 0.398

Work example - SRCL

Improve the microseismic noise & 1-4 Hz noise of SRCL, and lower BW of ISC loop.

SRCL is a good example for benefits of improved system. Largest contributor to Control Noise at 10 Hz at LHO BW focus of current scrutiny - FF used to improve DARM one of the drivers for balanced homodyne detection

Good illustration of the difficulties for implementation.

Hit the highlights of how we can make SRCL much better.

- SRCL now, UUG = 12 Hz , residual driven by 1-4 Hz motion.
- to make SCRL better, need lower ISI motion, lower OSEM noise, lower MICH drive coupling, and at least one other thing.

example data from LHO on Feb 28, 2020 - during the record setting 48.8 hour coincident lock stretch.

Intro to SRCL

Signal Recycling Cavity Length (SRCL)
 SRC comprises 6 optics on 5 different tables
 Goal: Reduce the BW of the SRCL loop,
 but preserve the RMS of the cavity.
 What is SRCL doing now?

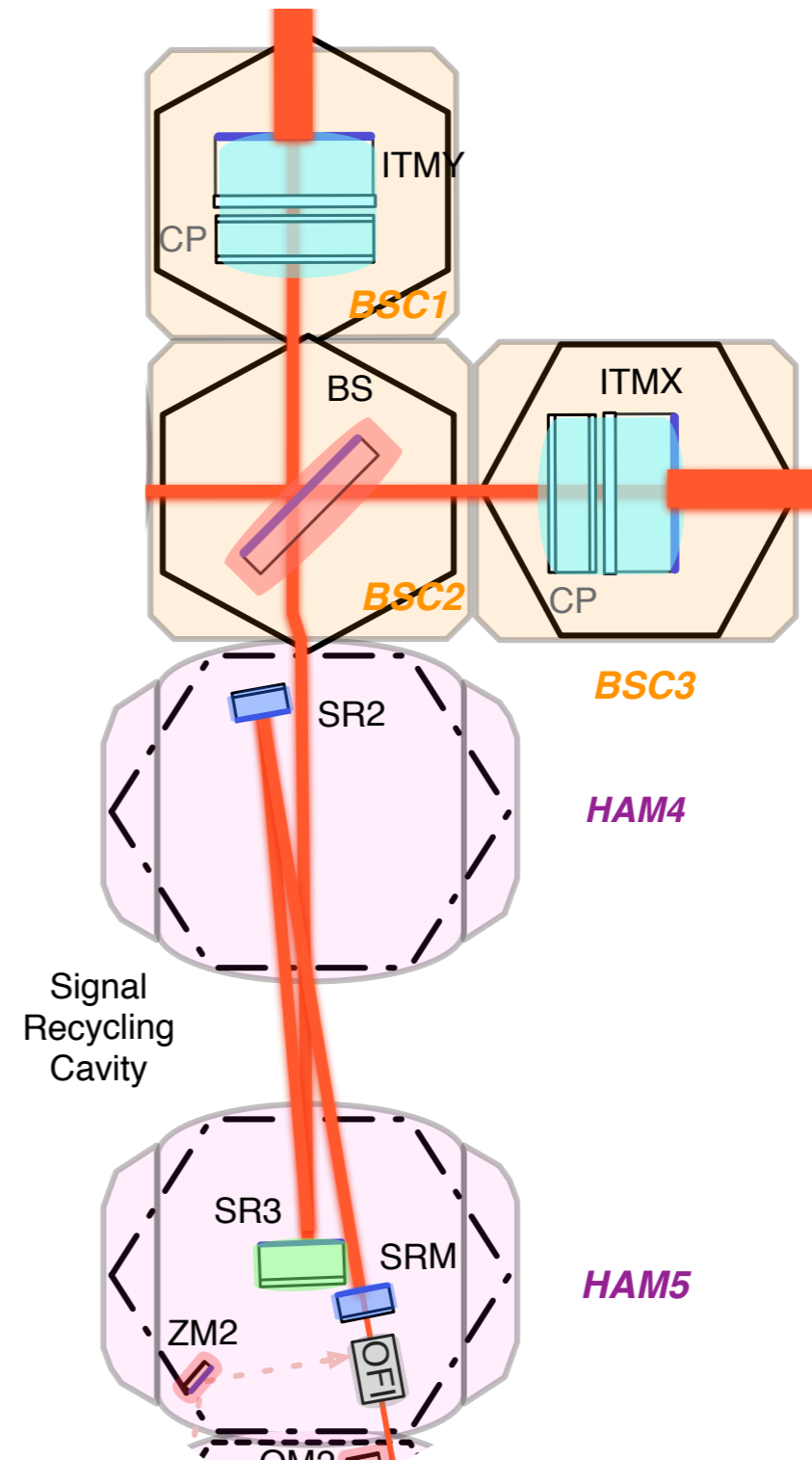

What is SRCL doing now?

Several ways of looking at SRCL:

red: ISI platforms at the Suspension points

yellow: Interferometer measurement between the mirrors, equiv. Open loop
(= red * trans. of suspensions + noise)

purple: actual SRCL IFO length
(= yellow * loop suppression)

green: RMS is about $1e-11$ m dominated by 1-3.5 Hz motion.

Control BW is about 12 Hz.

To reduce BW and keep RMS, reduce optic motion at 1-3.5 Hz.

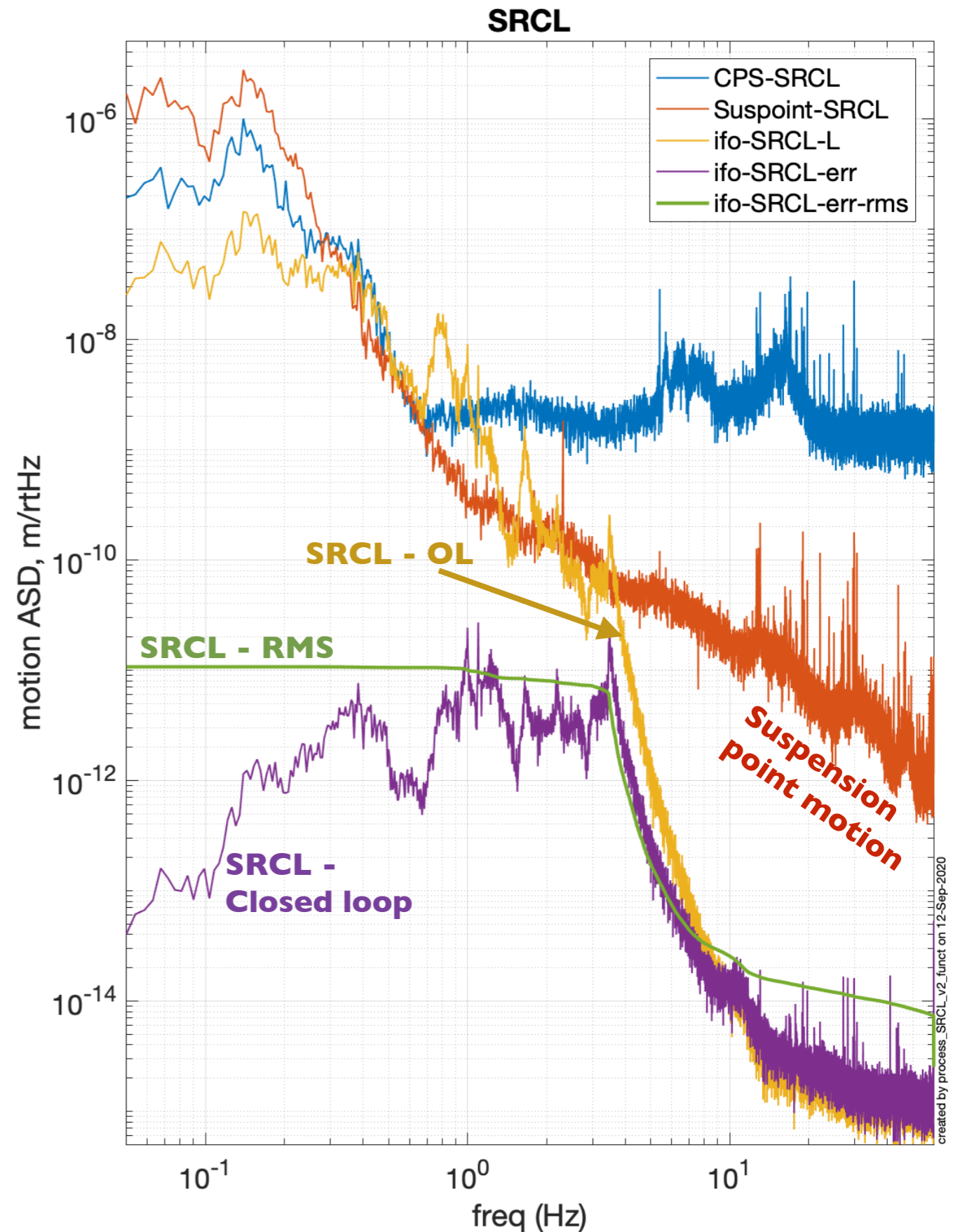

SRCL

Biggest (understood) contributor is SR2:

- HAM-ISI motion $>$ BSC-ISI motion
- SR2 gets 2x from reflection
- SR3 isolation slightly better

Work example to how to improve the motion of SR2.

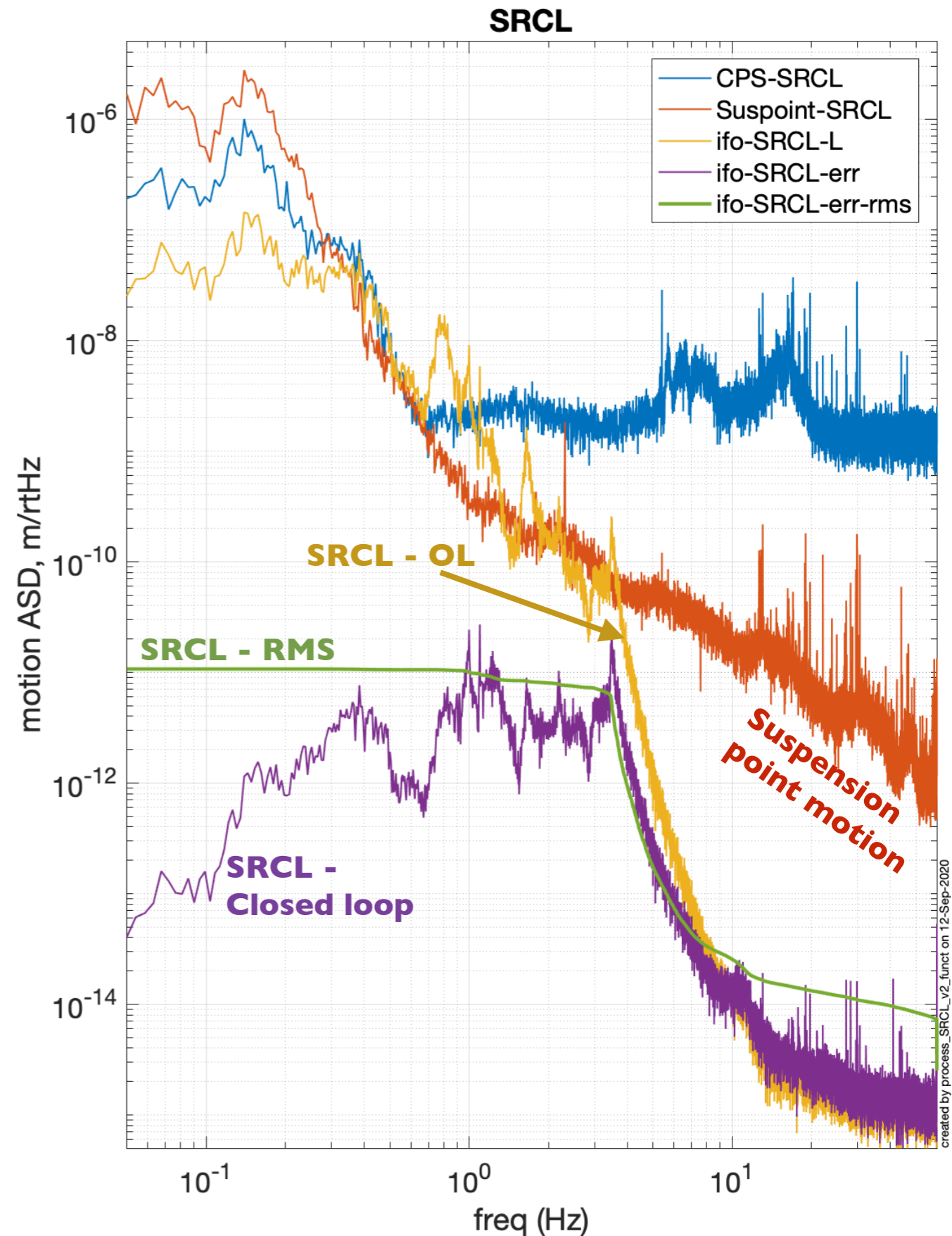
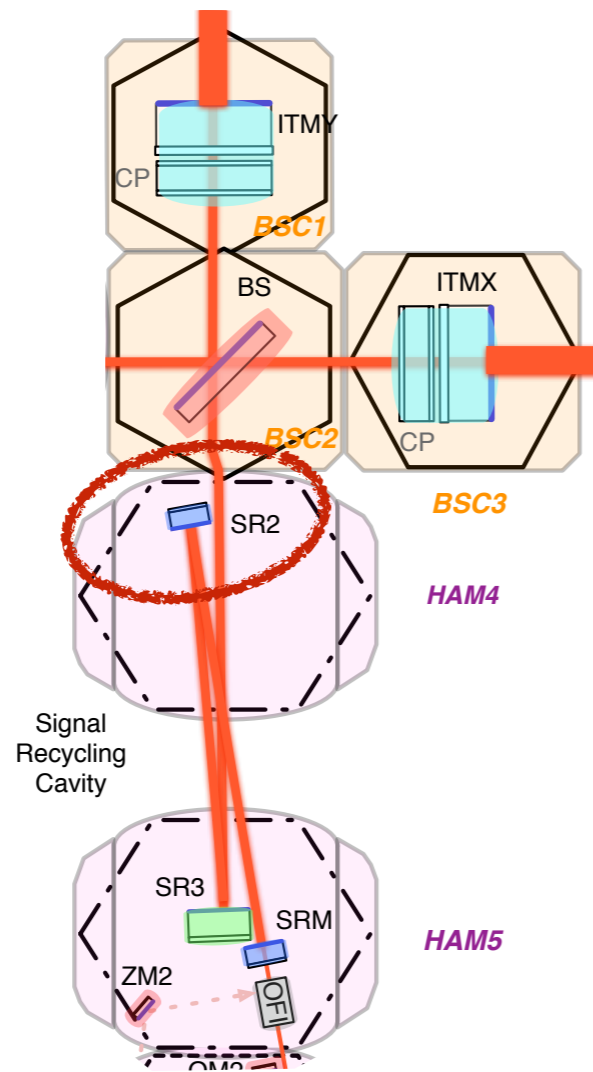

SRCL, SR2 example

Coupling from ISI motion and OSEM L noise is similar above ~ 0.6 Hz (with current damping loops.

Current OSEM noise and ISI SUSpoint motion are similar...

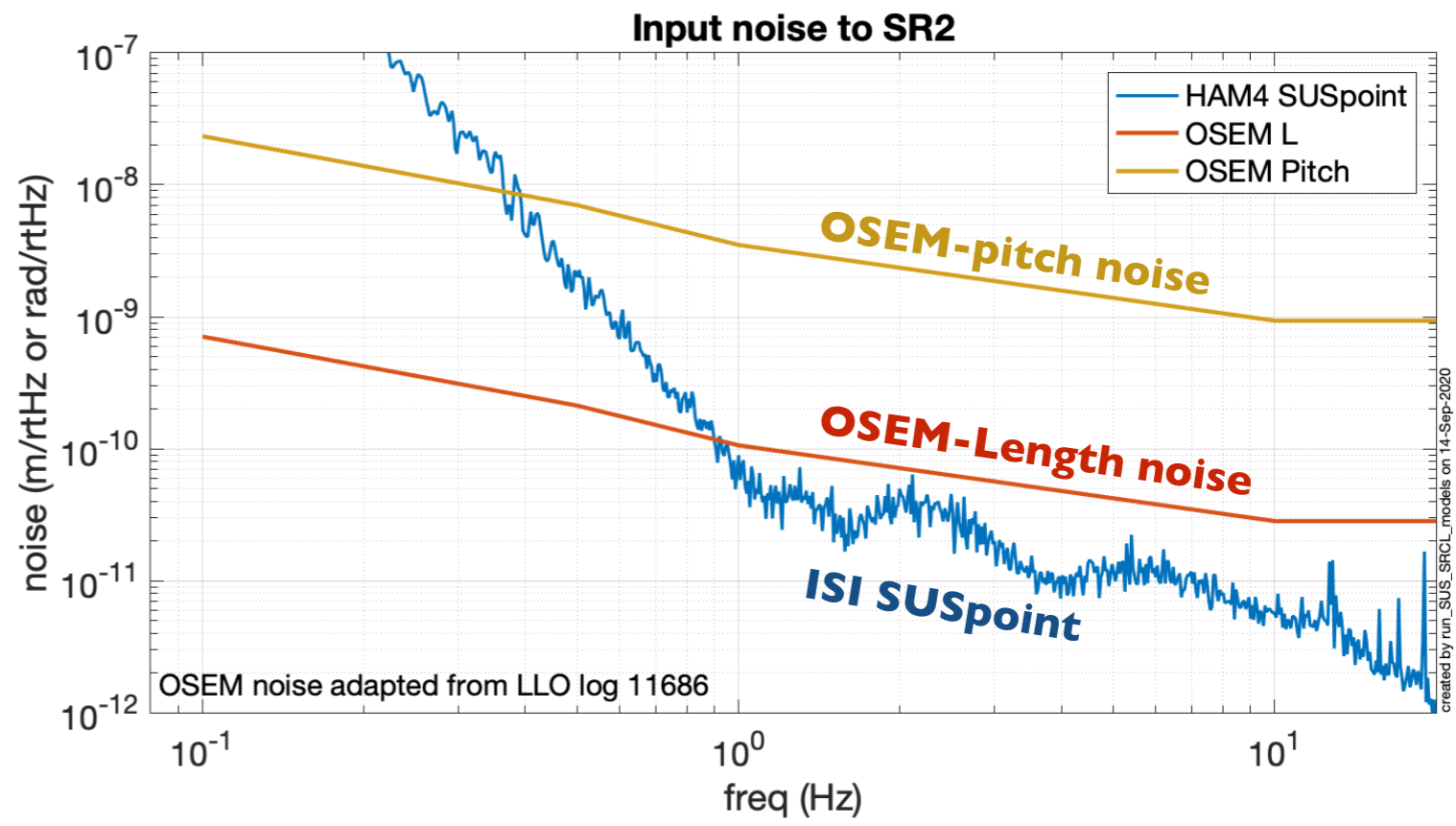
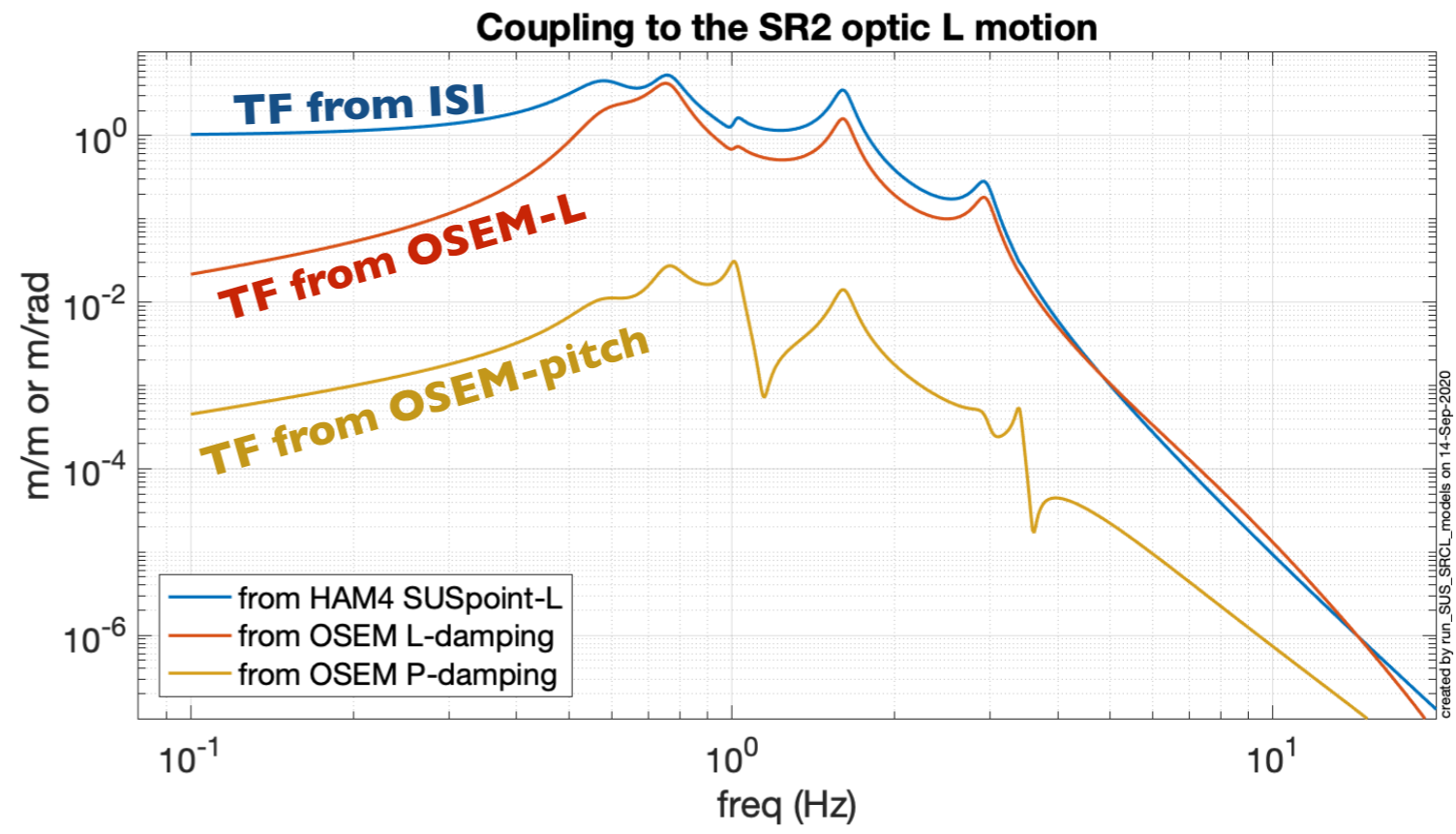

SR2 motion

To lower the motion of SR2, you need (at least*) to get lower noise OSEMs and lower noise ISIs.

We know how to do this:

OSEMs - replace with compact interferometric sensors (e.g. HoQI, Euclid, sensor from F. Guzman's Texas A&M talk yesterday,...)
 (I'm using the HoQI in this model.)

ISI - Optical lever & SPI between tables to improve tilt and diff. translation. Fine CPSs for tilt, and (likely) a single T120 H for better Z.

This is not a trivial upgrade.

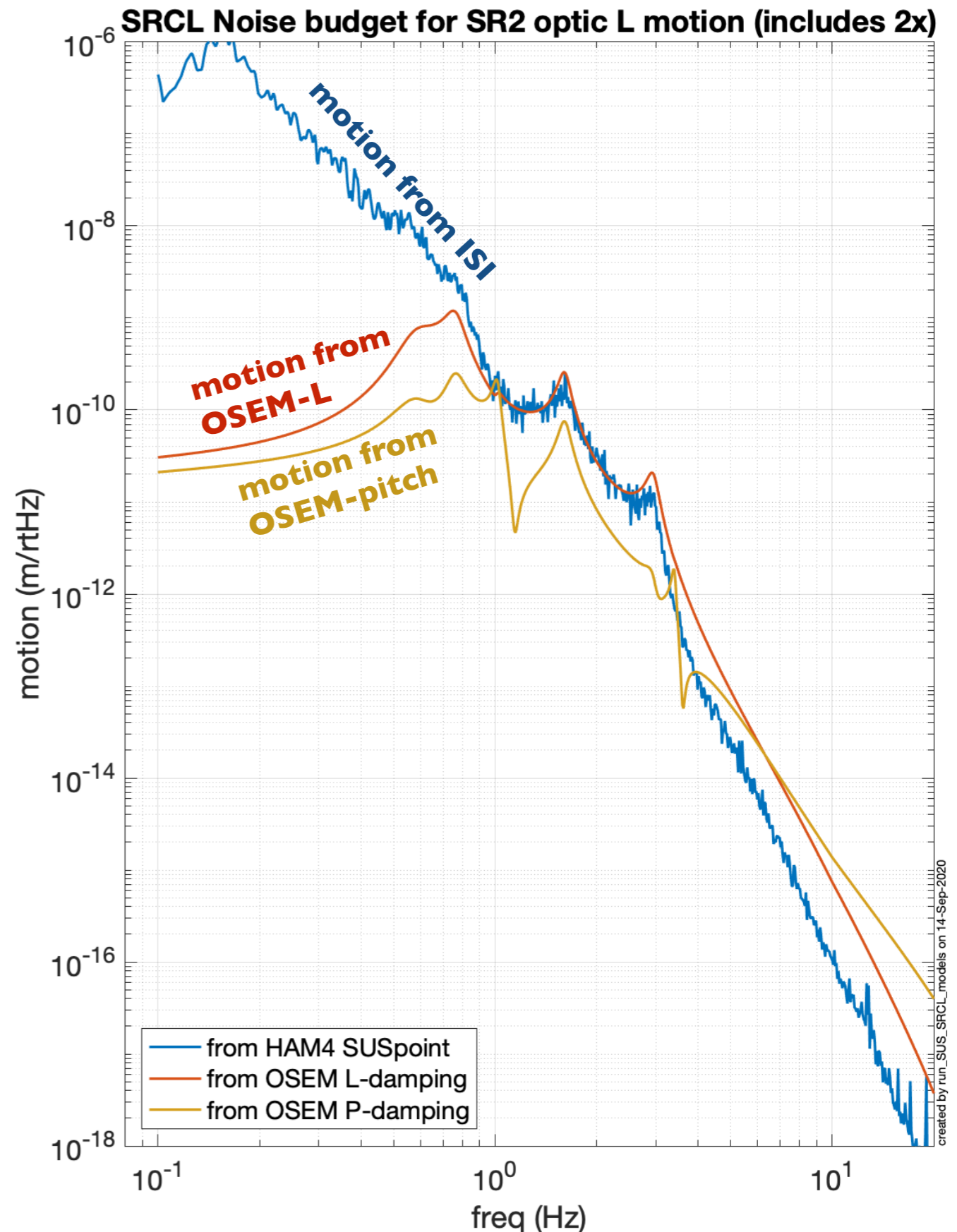

(*) see slide of SRCL subtraction later...

Change the noise level of the inputs

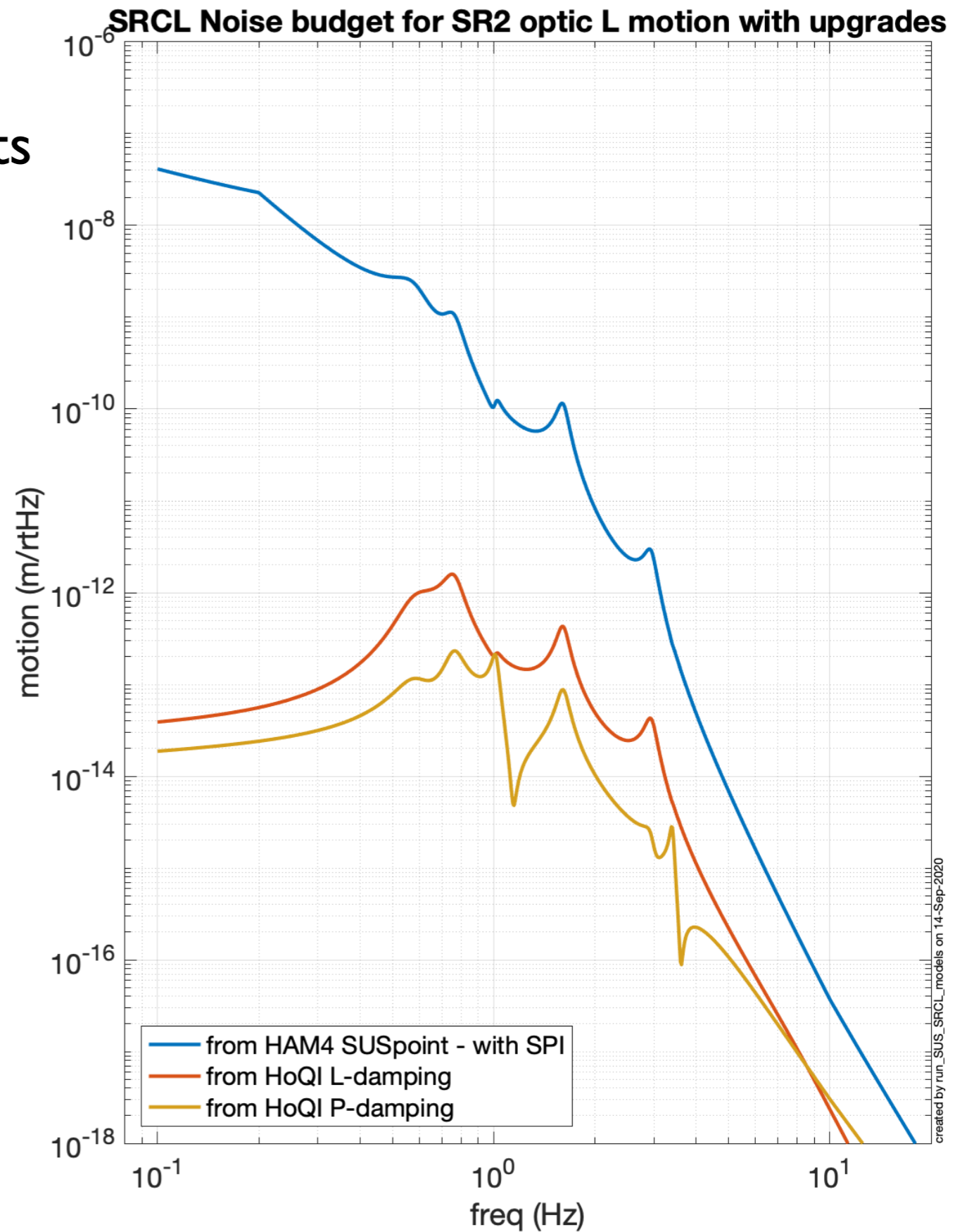
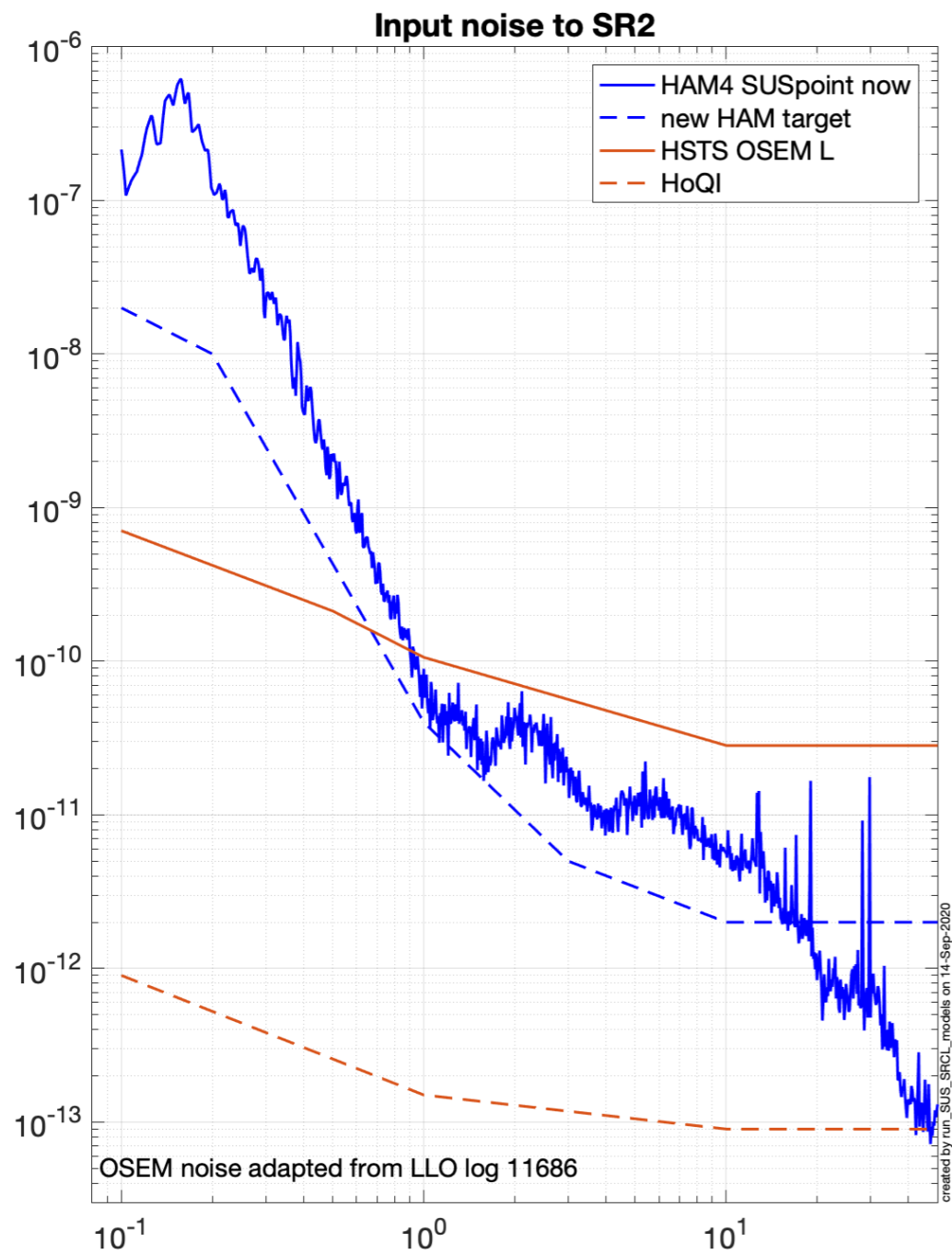

SRCL loop impact

RMS motion of SRCL
new OSEMs, SPI, and UGF of 5 Hz

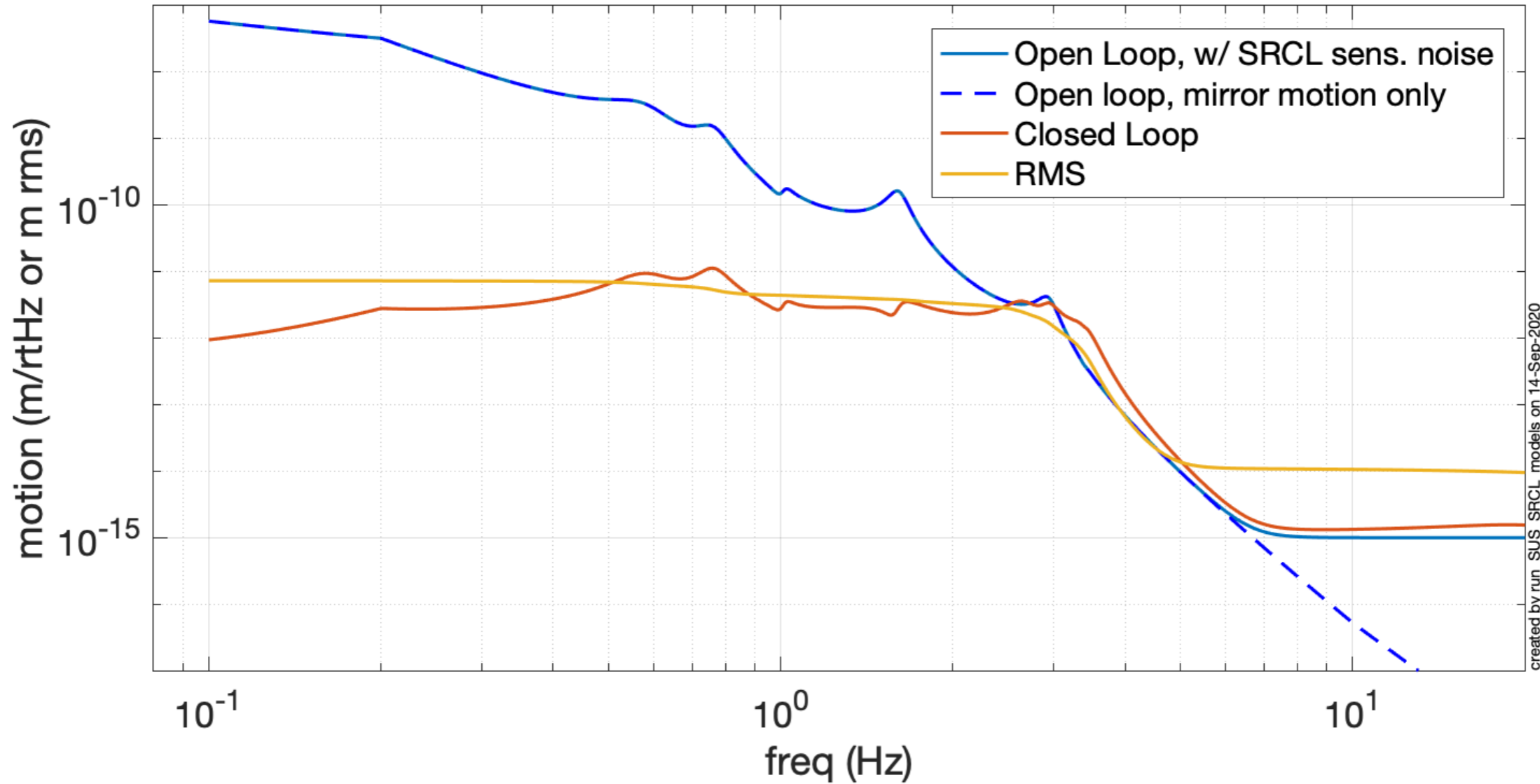

created by run_SUS_SRCL_models on 14-Sep-2020

Interferometric OSEMs

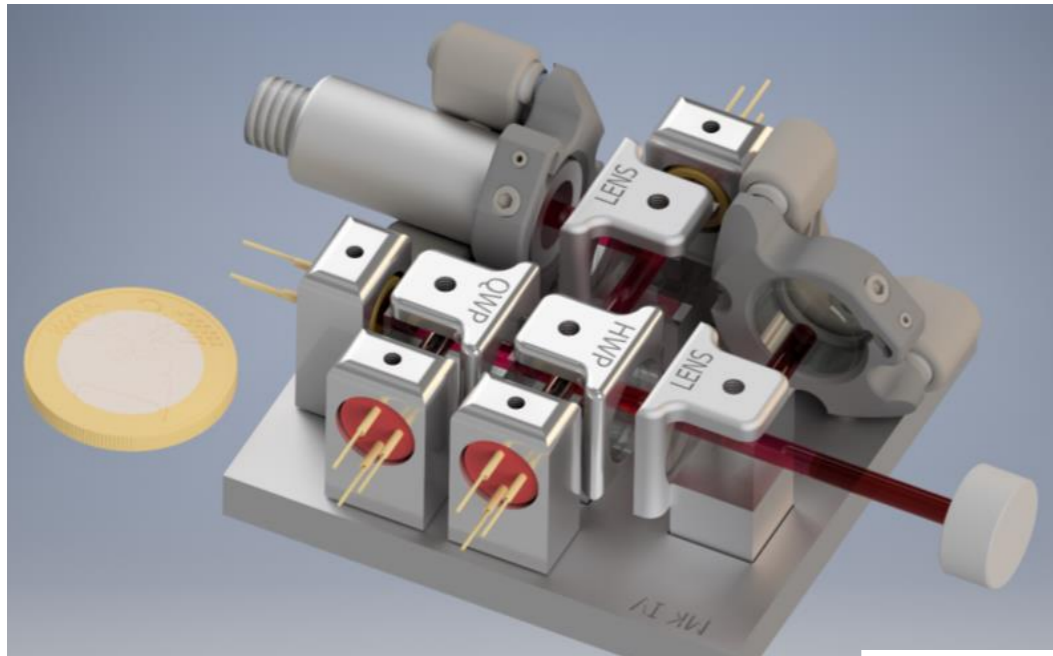

Homodyne Quadrature Interferometer
(HoQI, fringe counting IFO)
Developed at Birmingham
see G1801759

Displacement Sensor Sensitivity (In air, no isolation)

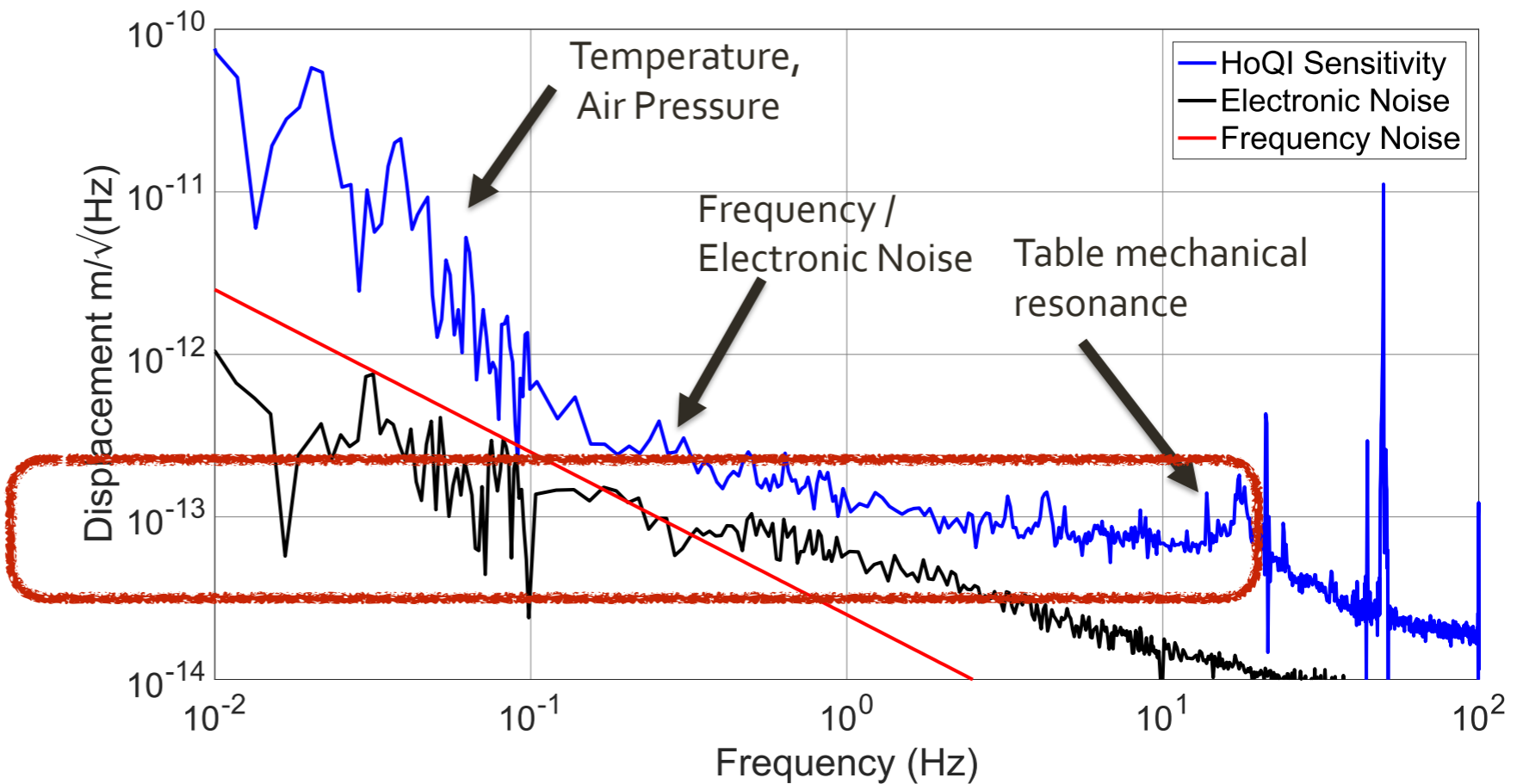

about 400x quieter
than OSEMs on SR2

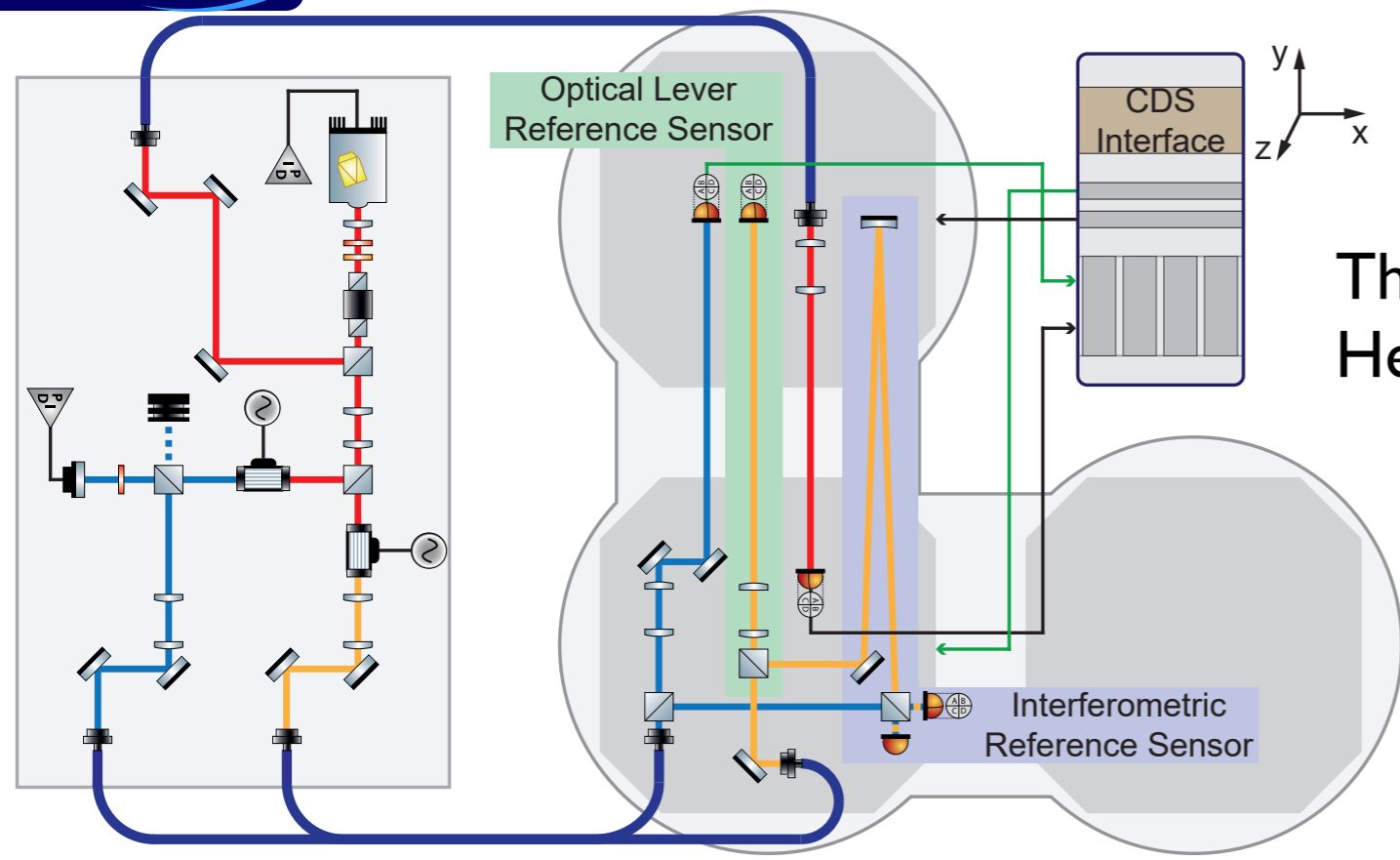

Seismic Platform Interferometer

Thesis work by Sina Köhlenbeck et. al at AEI
Heterodyne IFO and optical levers

Figure 4.1: Schematic overview of the optical lever positions and the reference sensors. These

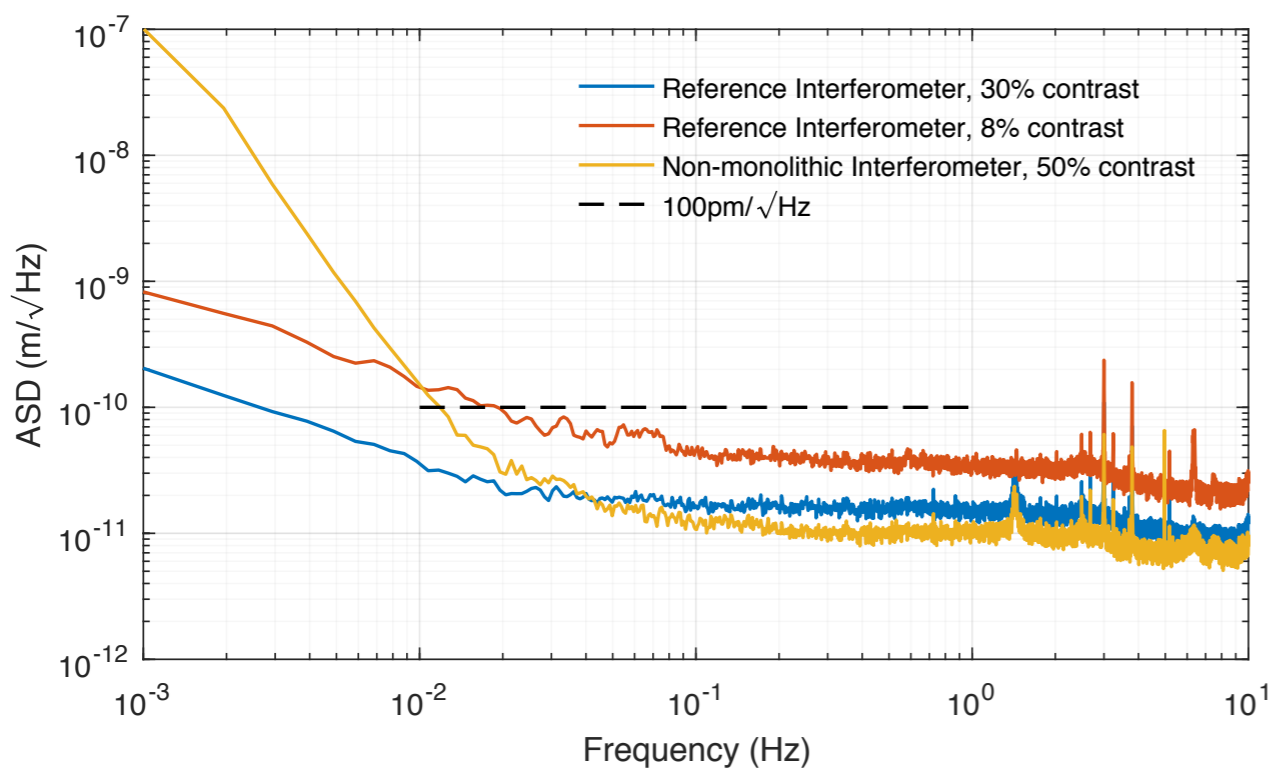

Figure 2.7: Displacement ASD of the two reference interferometers and the non-monolithic test

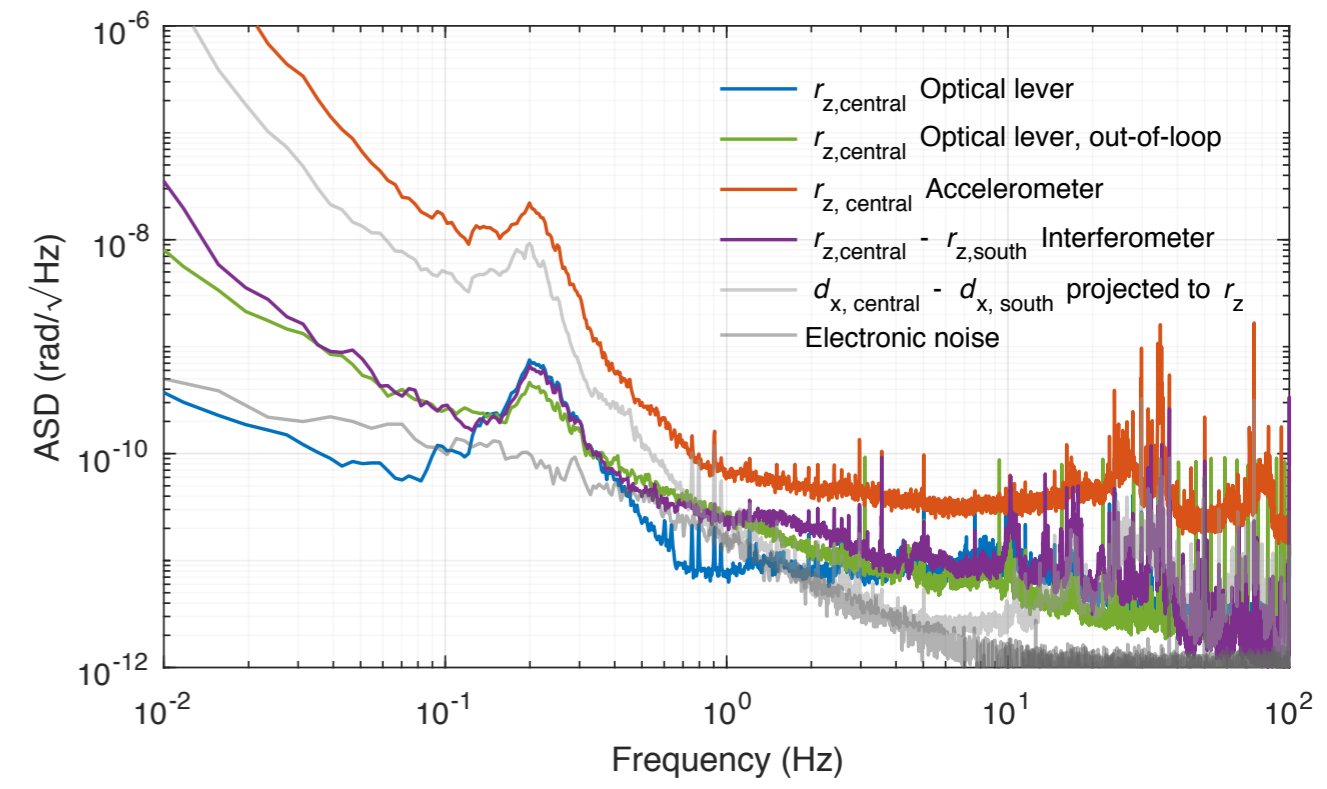
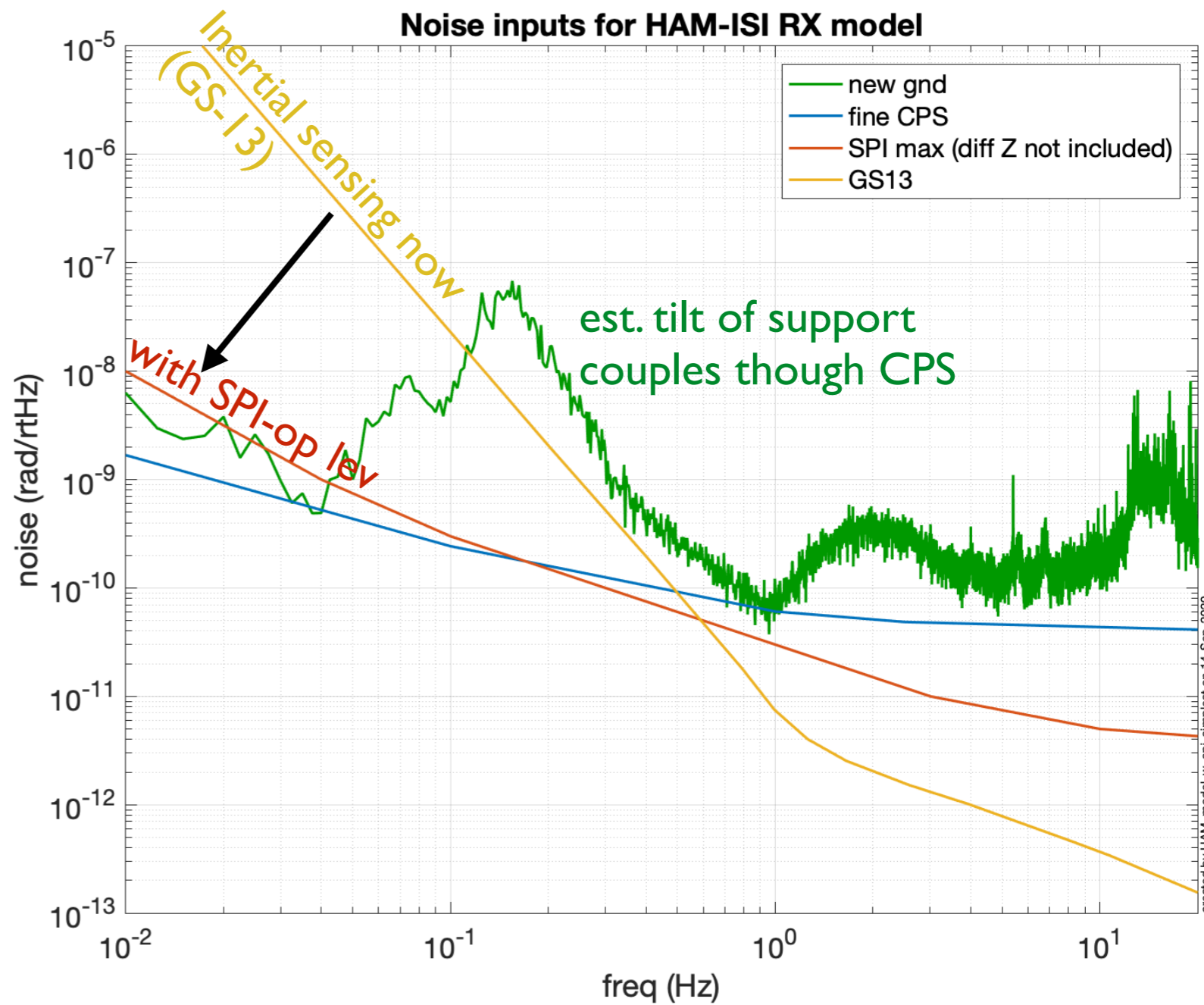

Figure 4.6: Angular displacement ASD of r_z of the central table. In blue, the measurement o

Apply optical lever to HAM-ISI

table-to-table optical levers enable much better tilt sensing at the microseism. (this model does not include limits from differential vertical motion between ISIs)



HAM model refs:
 T1300645, J. Kissel
 T1800092, S. Cooper
 {SeismicSVN}/seismic/HAM-ISI/Common/hamISIModel2018/

Tilt sensing for HAM-ISI

Effective tilt sensing improves dramatically at microseism, and also slightly above 1 Hz, because CPS noise is removed more effectively

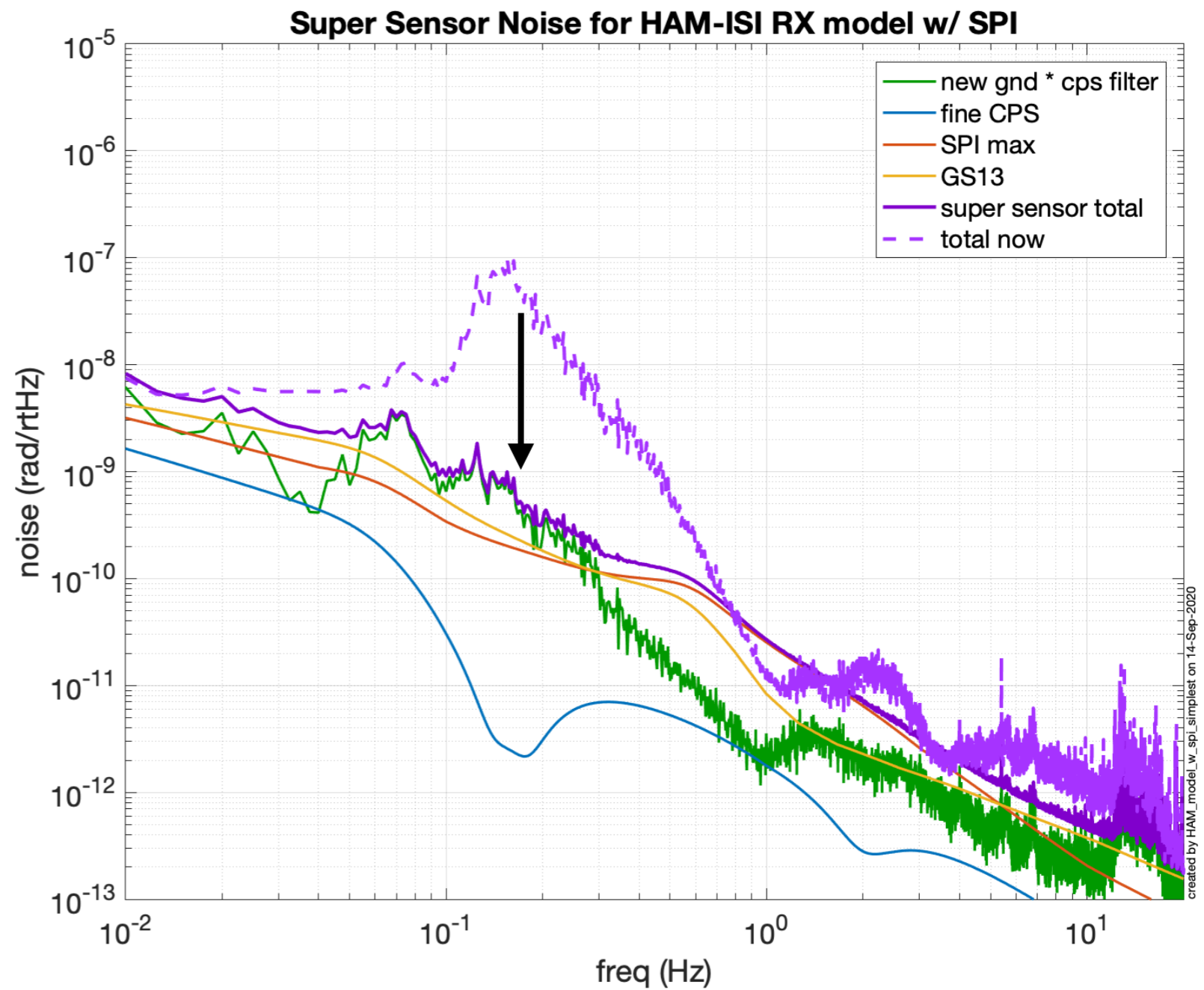

better overall tilt motion

better sensor allows better control with the loop.
Noise above 10 Hz not improved this way.

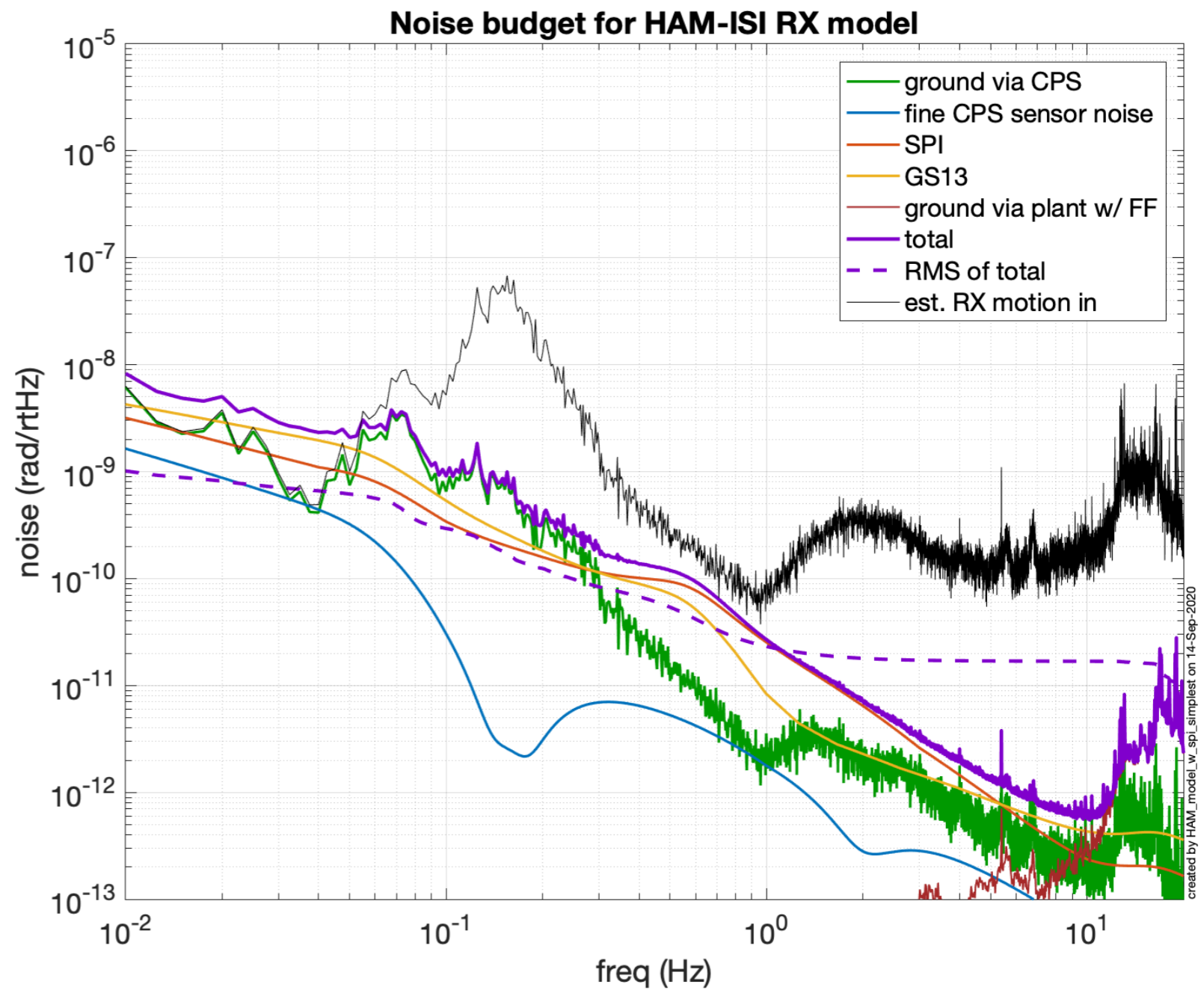

Lower tilt noise = better translation sensing

Horizontal seismometers see tilt * (g/w²) as a noise source.

Today, tilt of the table dominates horizontal sensor signal at the microseism.

Lower tilt will allow us to measure real translation with the feedback sensor.

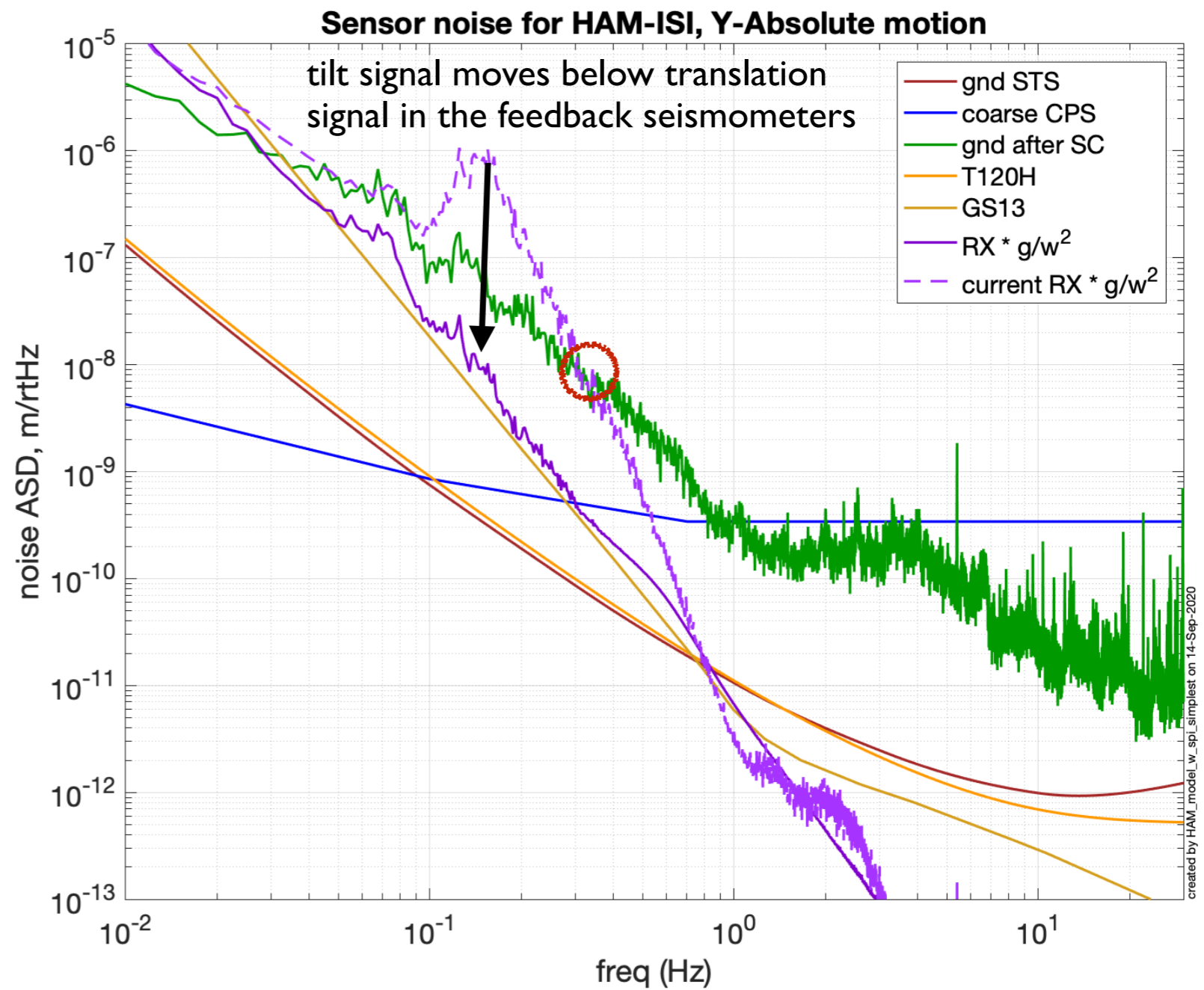

Horizontal motion can be much lower

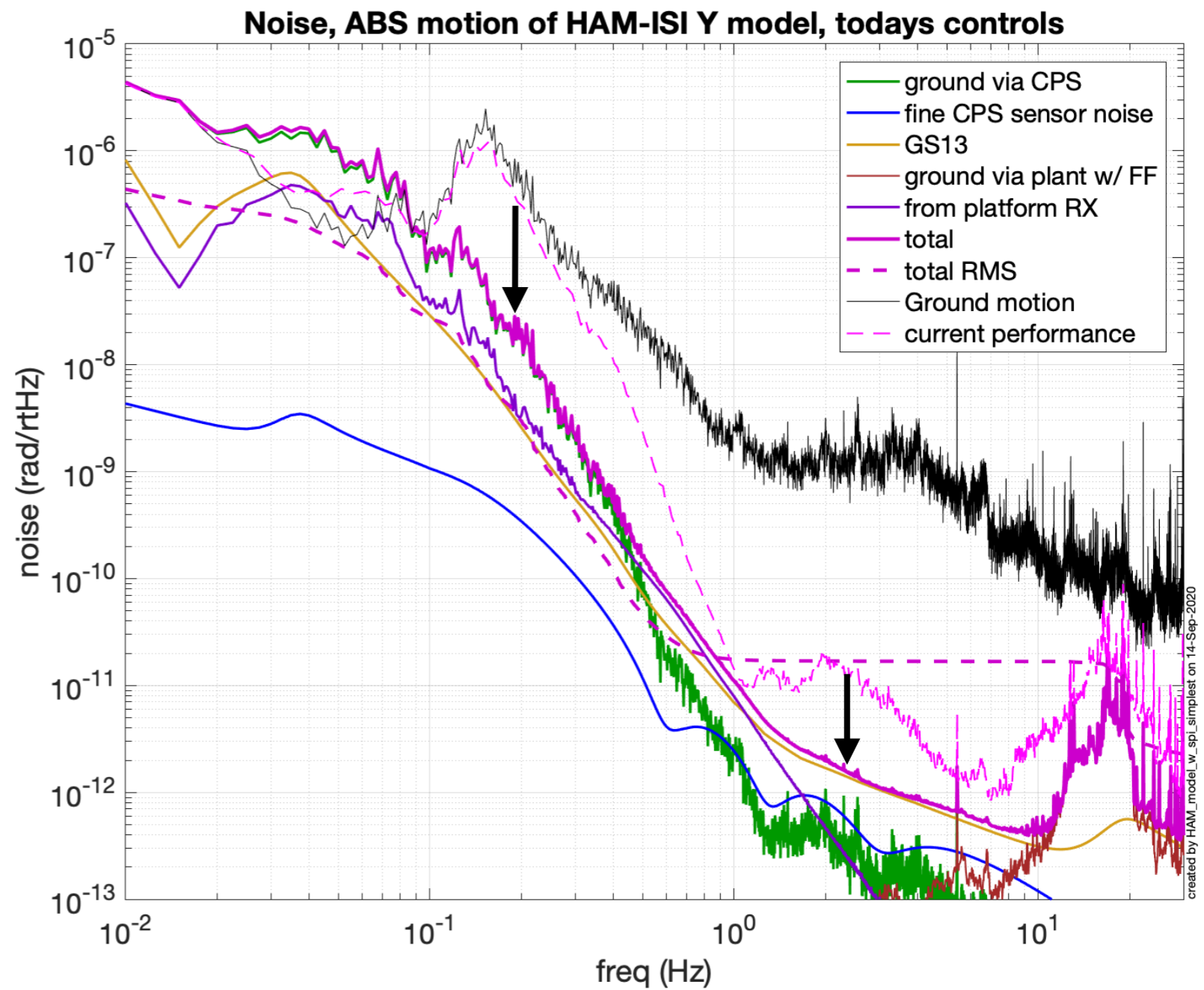

Now add the SPI

The noise of the SPI is less than the differential motion below about 1 Hz.

Close a control loop with the SPI signal.

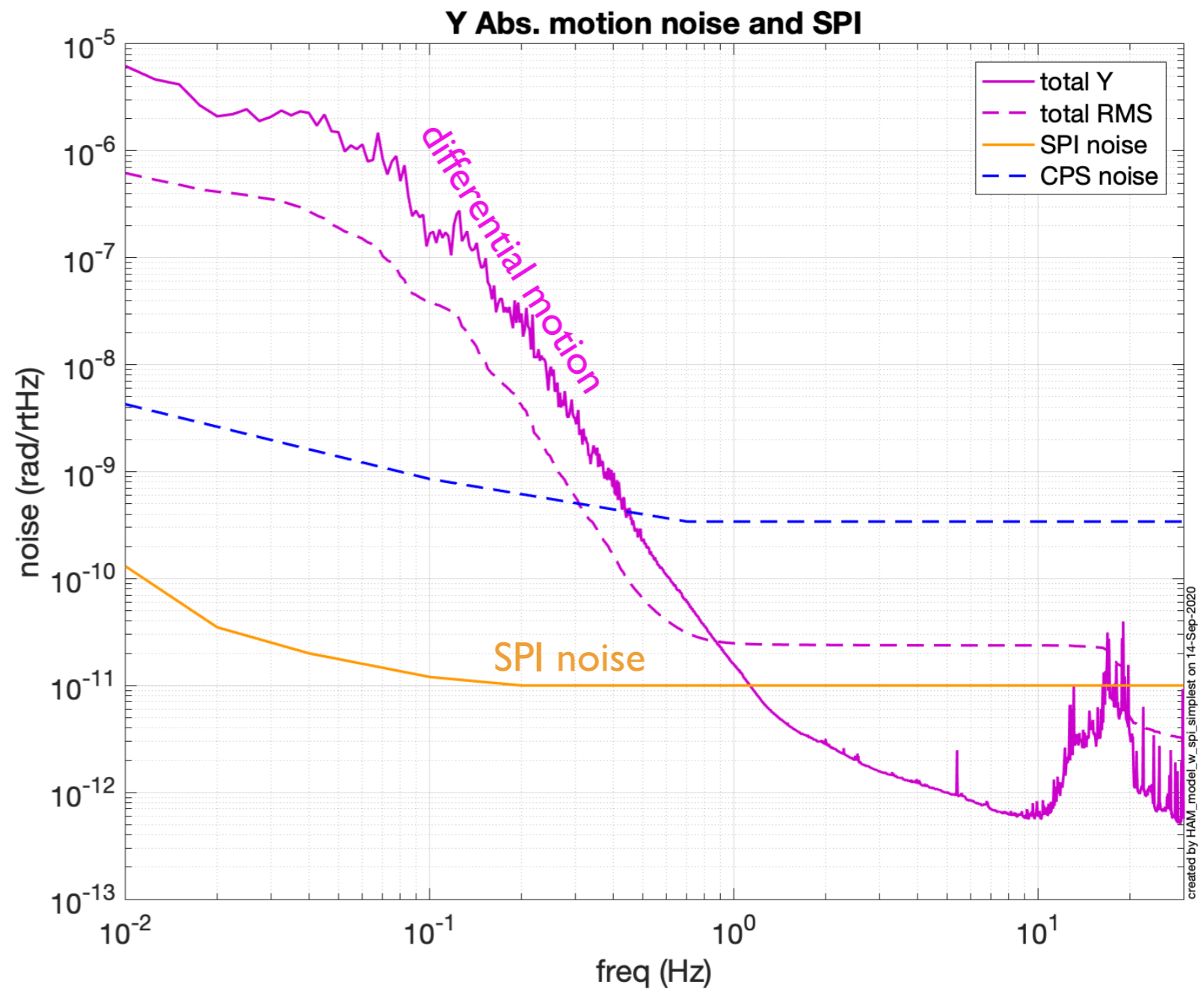

The noise of the SPI is less than the differential motion below about 1 Hz.

differential Y motion - SPI loop closed

Close a control loop with the SPI signal.

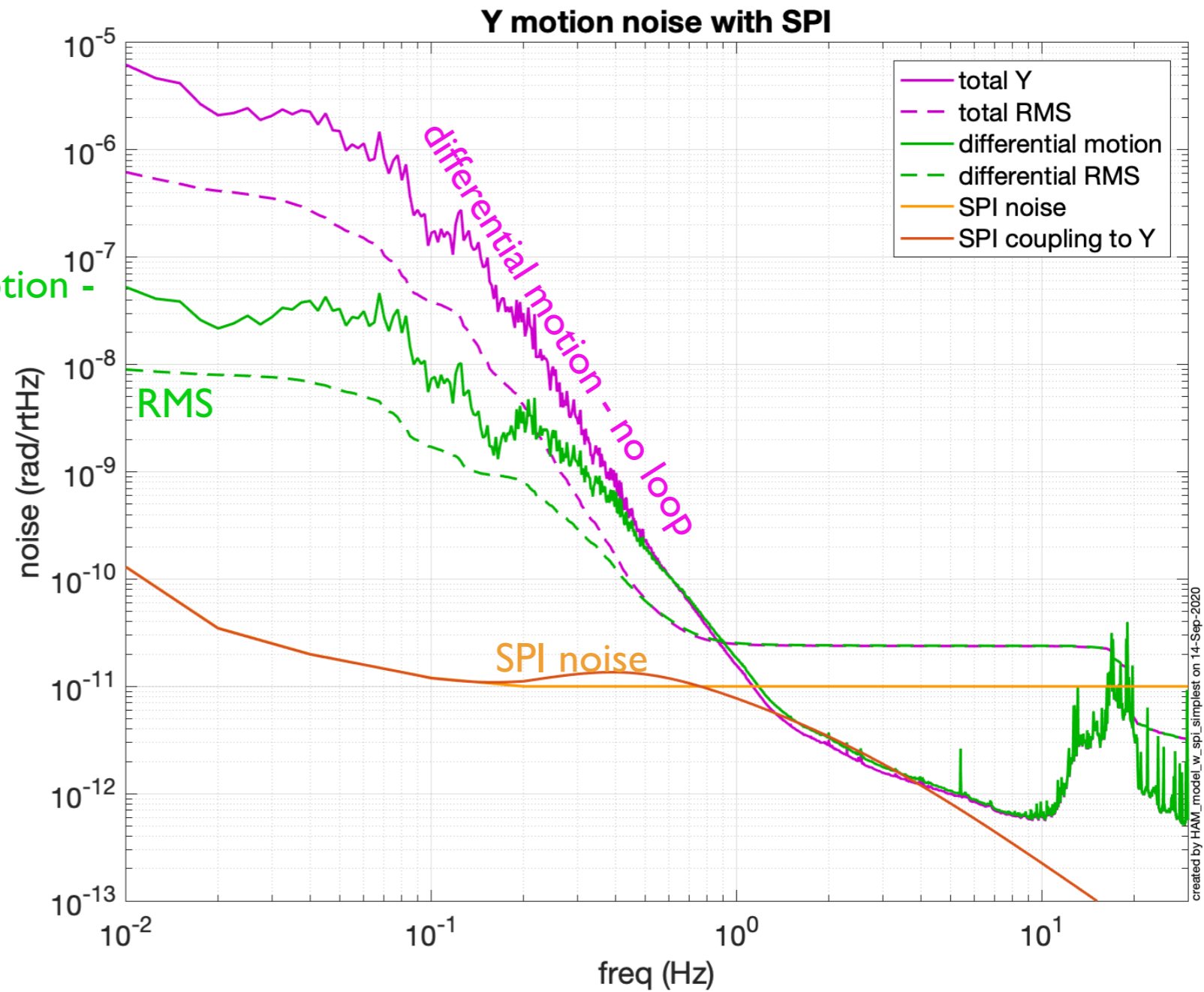

Include the RX to get the SUSpoint motion.

Total is below the new target below 10 Hz.

bump above 10 Hz is from direct coupling through the plant.
(feedforward? more bandwidth?)

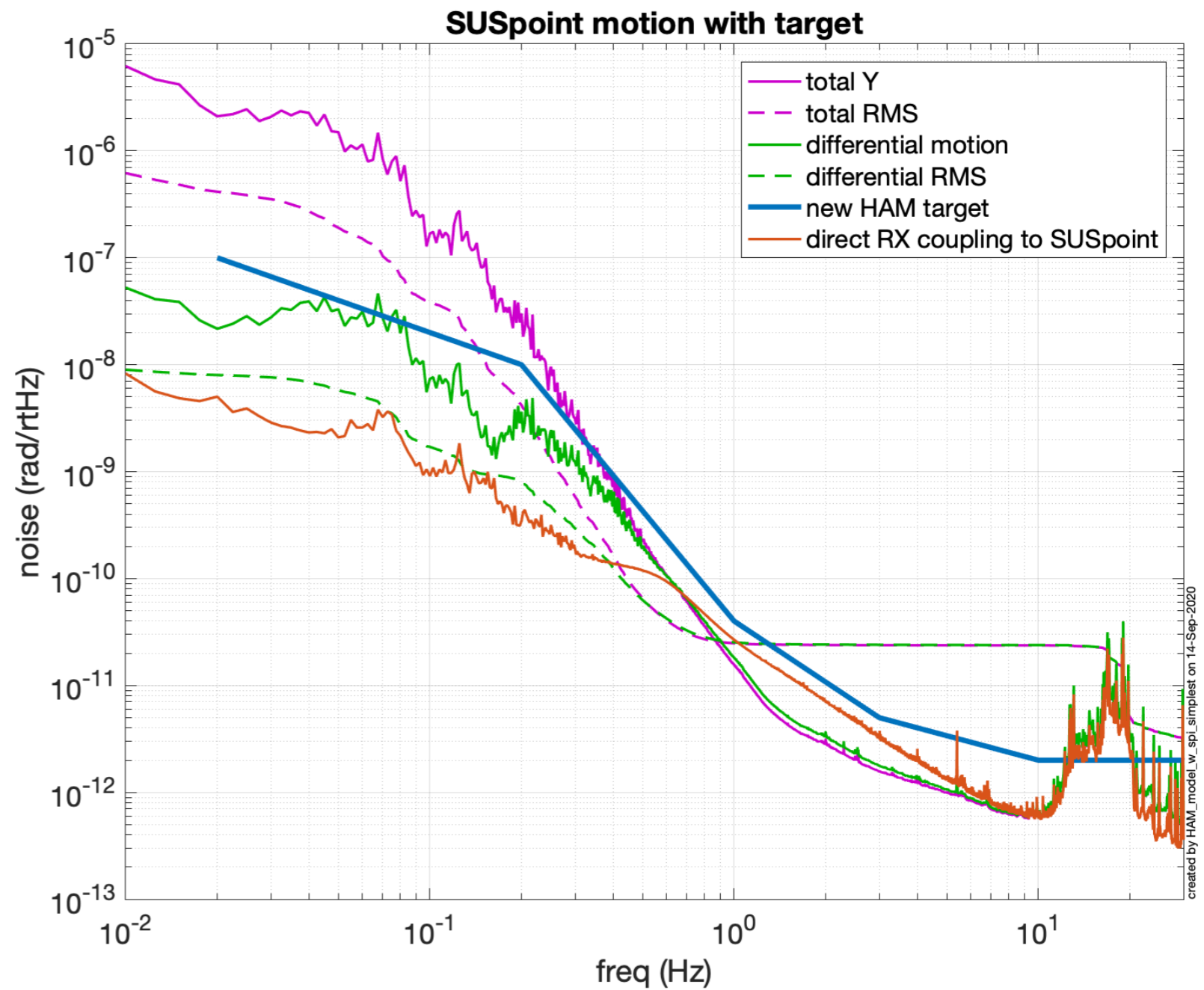

Wrap up

- There is a path to achieve a much more stable interferometer, with better tilt sensing and optical connections between the seismic tables.
- RMS motions of 10s of nanometers, instead of \sim micron.
 - *This will improve the uptime.*
- Mirror controls should be \ll a wavelength.
 - *This should improve the glitch rate from seismic stuff.*
- This will lower the control noise in the detector. Can we push control noise below the fundamental limits all the way to 10 Hz? This is the goal.
 - *This will improve the range.*
- This is not a trivial amount of work or money to install a full system.
- The improved science and the lessons we learn for 3G machines make it worthwhile.

The Compact BRS

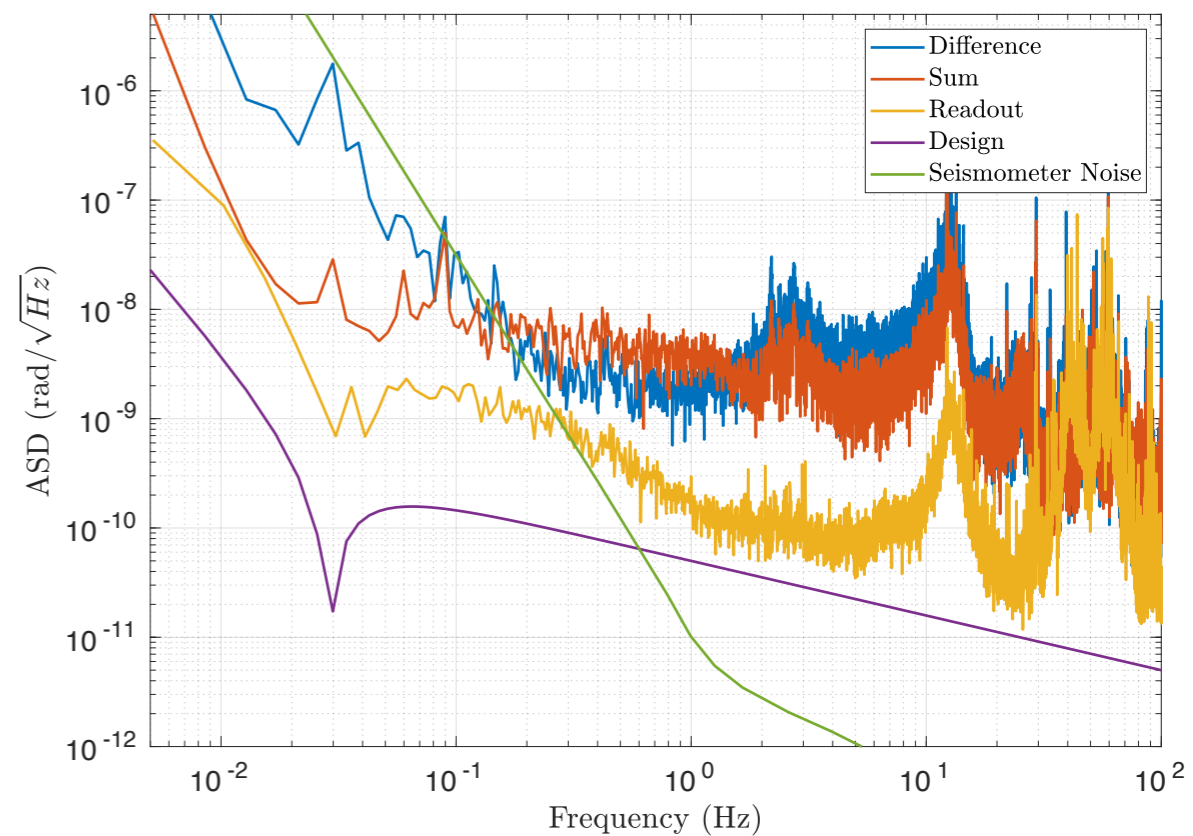
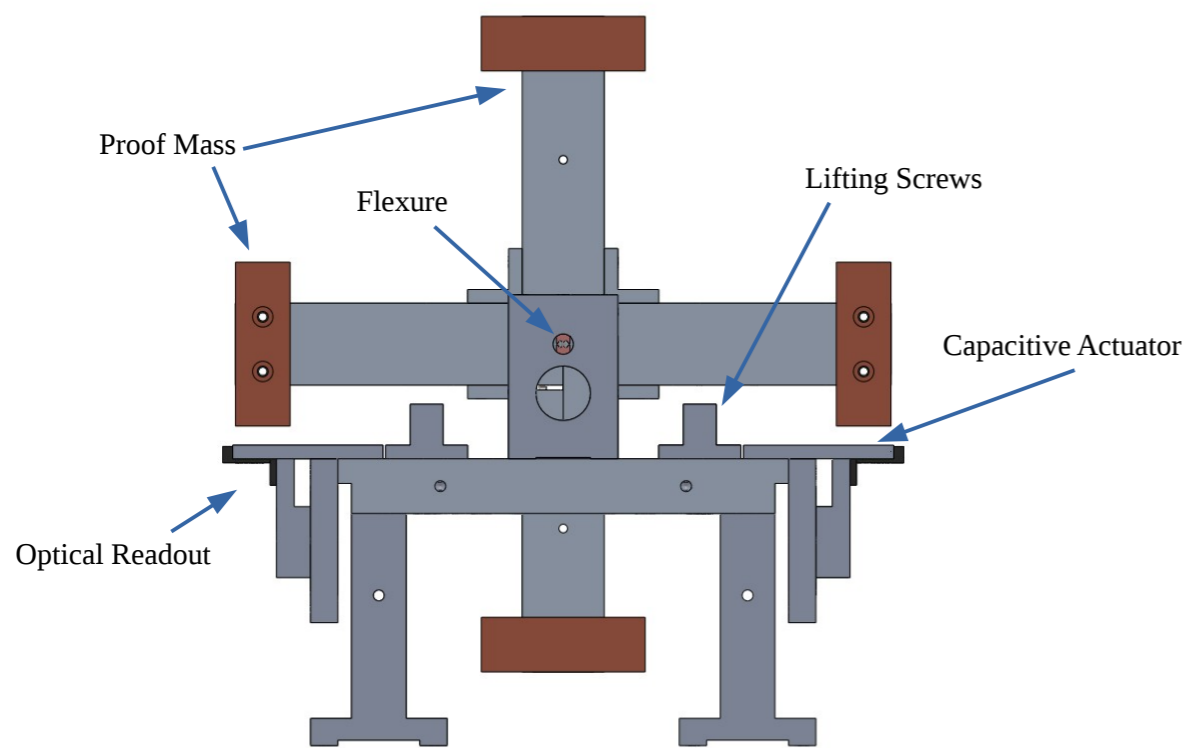

Figure 3.4: CAD rendering of the compact BRS (cBRS) showing the cross with its copper end masses which is hung from the flexures from the surrounding support structure. The translation stages which hold the fiber interferometer readouts can be seen on either end of the support below the two horizontal end masses.

Figure 3.11: Prototype cBRS noise performance showing the sum and difference of the two readouts. Additionally shown are the readout noise measured while the beam balance was mechanically locked, the design sensitivity, and the sensitivity of the current Stage 2 rotational sensors.

The performance of the ASC system was modeled for the seismic performance with the cBRS installed, Figure 3.19, and without, Figure 3.1. In both situations, the high frequency performance is limited by sensor noise which leaks into the gravitational wave band. The primary retuning that can be made with the inclusion of the cBRS is a decrease in the ASC UGF from 5.23 Hz to 2.93 Hz. Above this the residual falls off as $1/f^5$.

Figure 3.20 compares the modeled residual for a system with and without the cBRS. As expected, adding the cBRS reduces the residual between ~ 50 -500 mHz due to the increased performance of the seismic isolation system. This allows a shift in the UGF to lower frequencies which reduces the residual above ~ 5 Hz.

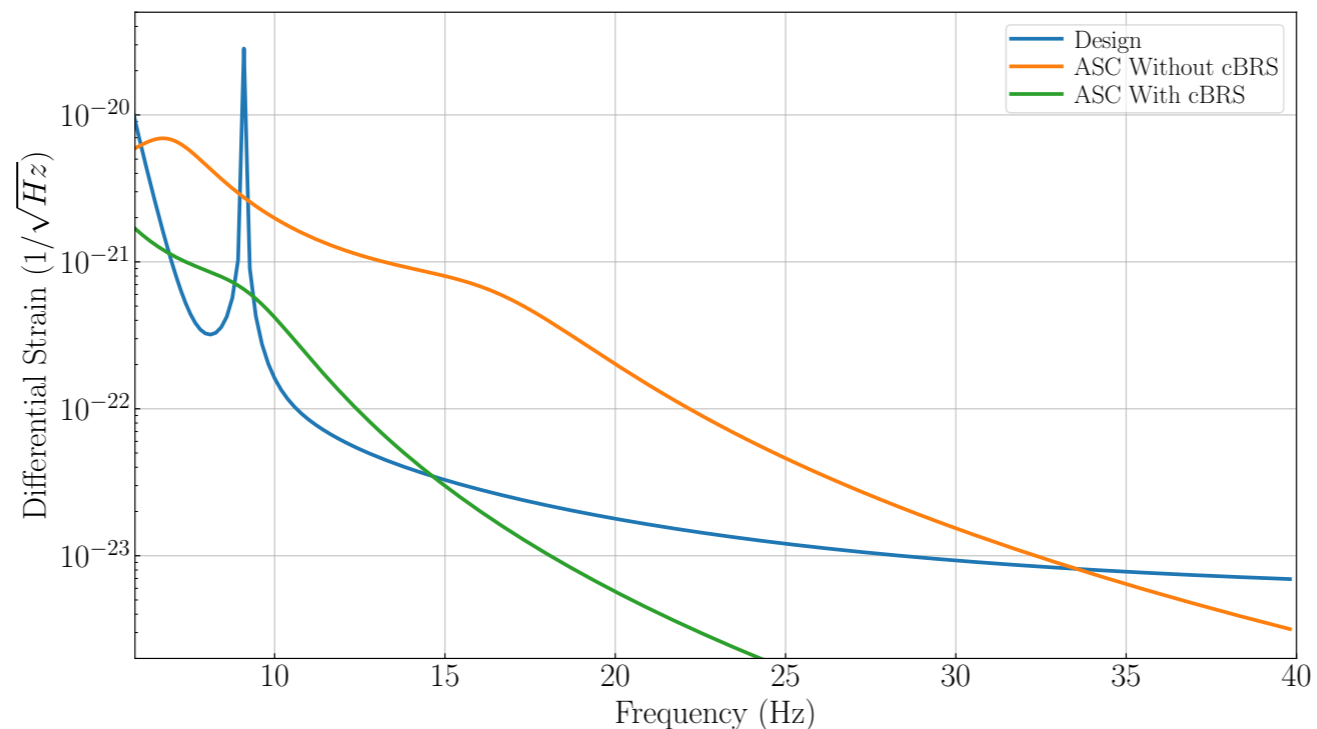
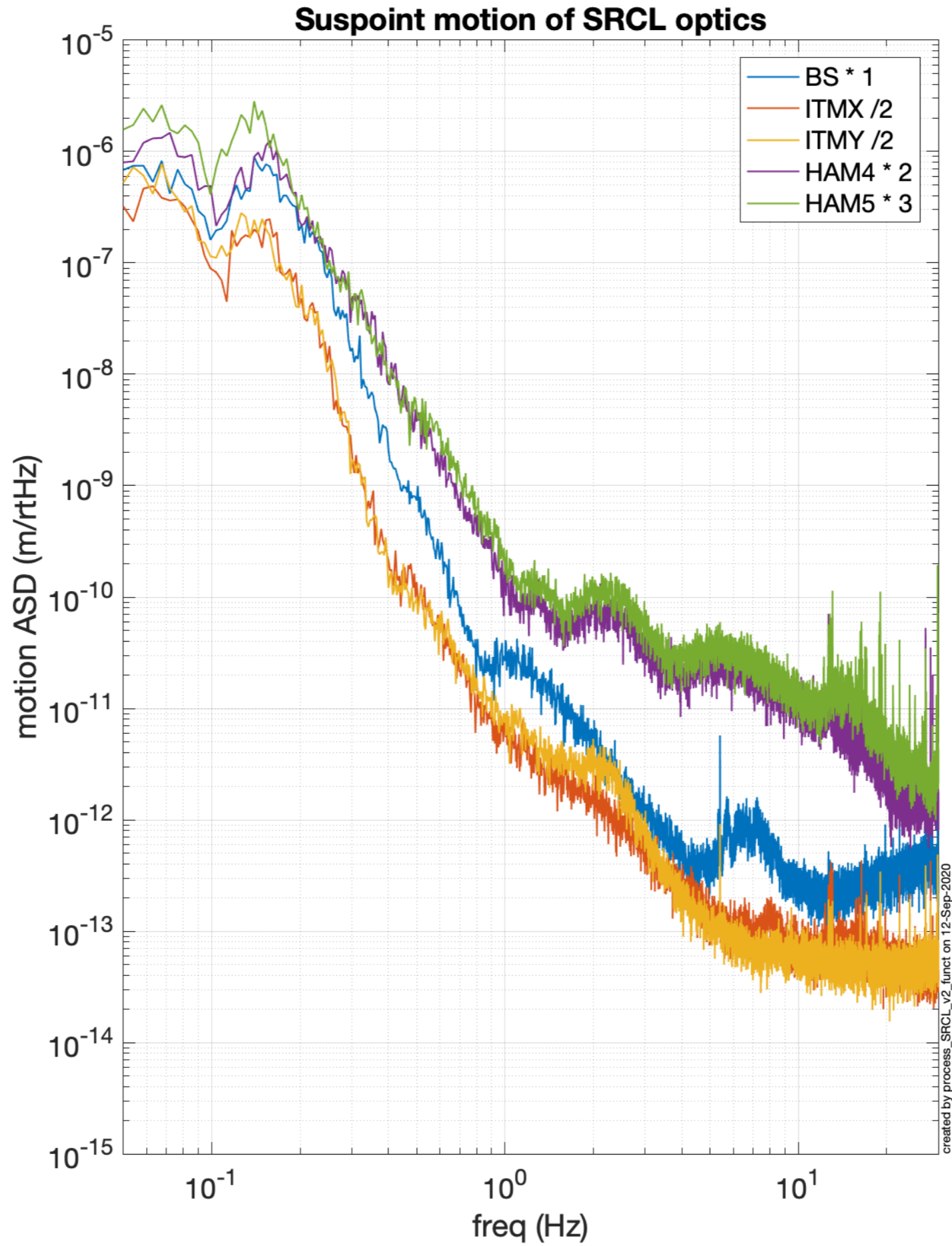
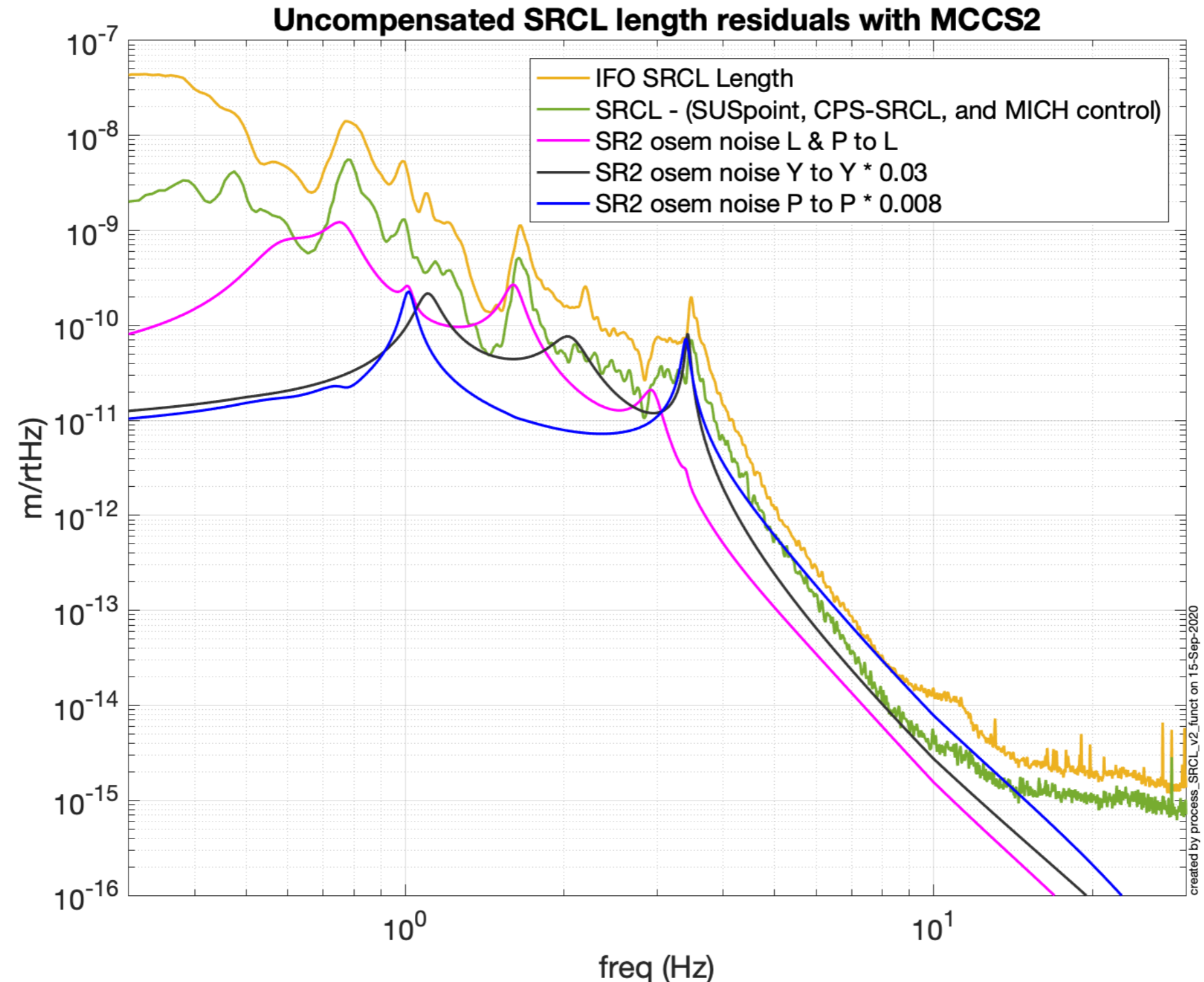

Figure 3.21: Projected low frequency strain noise with and without the cBRS along with aLIGO design sensitivity. [16]



update to noise budget

The mode at 3.5 Hz is pretty well aligned with a mode in pitch and a mode in yaw.



The SRCL residual plot

Yellow is the SRCL length
(equiv. open loop)

Purple is the residual after all the coherence
with ISI CPS and ISI SUSpoints are removed
(MCCS2)
(big change below 0.8 Hz, not much above 3.5)

Green is after also removing MICH control.

Magenta is the noise budget for the OSEMs.

What driving the SRCL motion above 0.8 Hz?
not ISI, not OSEM, not any other ISC drive signal
in L, P, or Y - checked but not shown here
The 3.5 Hz peak might be pitch? or vertical?
drive could be DAC?

Uncompensated SRCL length residuals with MCCS2, slightly smoothed

